

# ITI HomeLink® Security Interface

(A Quik Bridge™ Family Product)

Document Number: 466-1237 Rev. A

July 1997

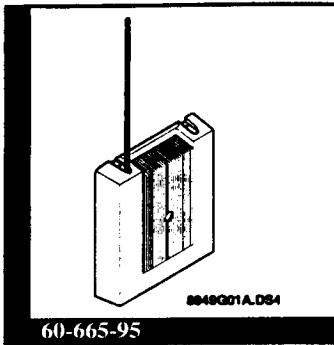

## Installation Instructions

## Product Summary

The ITI HomeLink Security Interface (Interface) lets users control security system functions from the HomeLink buttons in their vehicle. The Interface can be set up to allow HomeLink buttons to arm and disarm the security system, control the lights in the house, and operate the garage door opener.

Figure 1 shows how the Interface works with the HomeLink buttons and the security system. The user presses a button on the HomeLink console in their car, which transmits a radio signal to the Interface. The Interface responds by transmitting a radio response to the security system control panel, or momentarily closing the on-board relay to open or close the garage door.

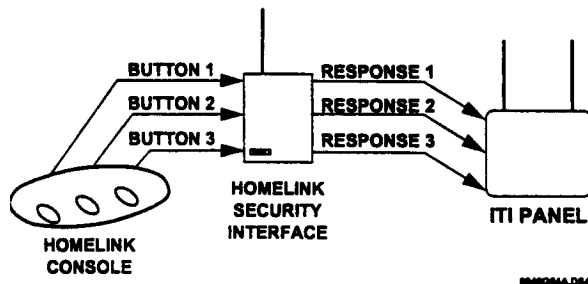

Figure 1. Radio Messages Into and Out of the Interface

Figure 2 shows the main components on the Interface circuit board.

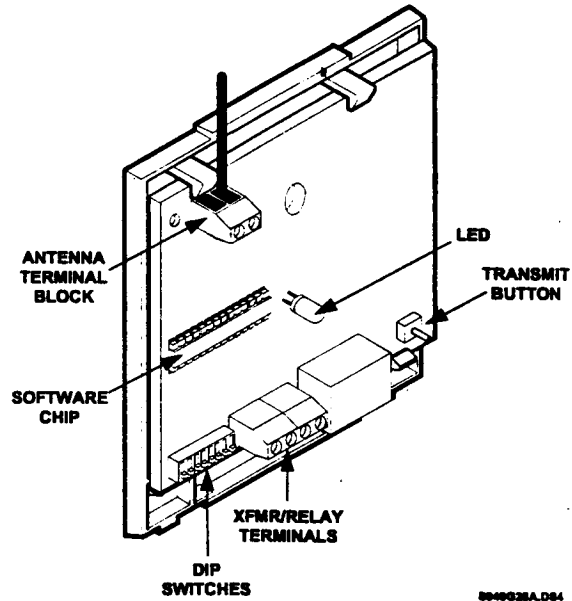

Figure 2. Interface Main Components

## Tools and Equipment Needed

- One 9.5" antenna (included)
- Screws and anchors (included)
- 9-VAC Class II transformer, ITI part number 60-515 (not included)
- 2-conductor, 22-gauge stranded wire (not included)
- Phillips and standard screwdrivers (not included)
- Vehicle with HomeLink button console (not included)
- Drill (not included)

## Installation Overview

To ensure successful installation, follow the installation steps as they appear below. Do not mount the Interface until instructed to do so.

- 1) Prepare the Interface for Programming
- 2) Program HomeLink Buttons and Verify Programming
- 3) Add the Interface to the Control Panel Memory
- 4) Assign the HomeLink Button Functions
- 5) Mount and Wire the Interface
- 6) Test the System
- 7) Give "Owner Information Sheet" to the Homeowner

## Prepare the Interface for Programming

To prepare the Interface for programming:

- Connect the antenna.
- Temporarily power the Interface with a wire long enough so the Interface can reach into the vehicle where the HomeLink buttons are located.

## Connect the Antenna to the Interface

- 1) Remove the Interface cover by pressing down on the top center of the cover and pulling it away from the base.

**Note:** Leave the cover off until after programming and mounting the Interface are completed and you are ready to test the system.

- 2) Loosen the inner (right) terminal of the antenna terminal block (see Figure 2).
- 3) Insert antenna into the inner (right) terminal.
- 4) Tighten the terminal screw.

## Connect the Transformer

- 1) Run a 2-conductor, 22-gauge (minimum) stranded wire from the transformer location to the Interface. The wire must be long enough so the Interface can reach into the vehicle where the HomeLink buttons are located.

**CAUTION:** You must be free of static electricity before handling circuit boards. Discharge yourself by touching a bare metal surface, or wear a grounding strap.



- 2) Connect one end of the wire to the Interface terminal block labeled XFMR and connect the other end to the terminals on the transformer (no polarity), as shown in Figure 3.

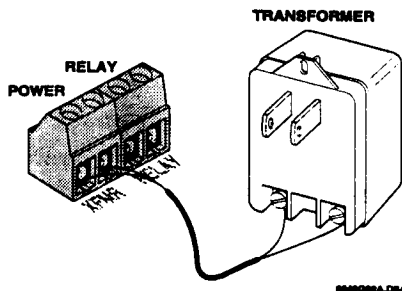
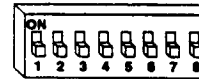

Figure 3. Connecting the Transformer to the Interface

## Power Up the Interface

- 1) Set the Interface DIP switch to:



- 2) Plug the 9-VAC Class II transformer into a non-switched 110-VAC outlet.
- 3) Check that the LED is on steady. The LED is used to indicate the Interface status as described in Table 1.

Table 1. Interface LED Condition and Status

LED Condition	Interface Status
On steady	Normal operation mode
Slowly blinking (1 blink per second)	Programming mode
Quickly blinking (5 blinks per second)	Transmitting RF signal (This occurs only when the transmit button is pressed.)
Flickering (20 blinks per second)	Power-up test failed (Call ITI Technical Support at 1-800- 777-2624.)

## Program HomeLink Buttons and Verify Programming

Before the HomeLink buttons can communicate with the Interface, the HomeLink buttons must be programmed with signals from the Interface using the following procedures.

### Before Programming HomeLink Buttons

Before adding Interface signals to HomeLink buttons, check with the homeowner to determine which HomeLink buttons, if any, are currently being used. You may choose to leave in-use buttons as they are, or re-program them with an Interface command signal.

**Note:** HomeLink buttons not programmed with an Interface command signal won't provide the response in Tables 2 through 6 of this document. See pages 4 through 7 for these response tables.

The HomeLink buttons may not work unless the vehicle is running. Check the vehicle owner's manual for details.

## Program HomeLink Button 1

- 1) Set the Interface DIP switch to:



- 2) Hold the Interface one foot from the HomeLink buttons. Then, using both hands, press and hold the Interface transmit button and HomeLink button 1 as shown in Figure 4.

**CAUTION:** Do not hold the Interface closer than six inches from the HomeLink buttons; otherwise, the HomeLink buttons do not program correctly.

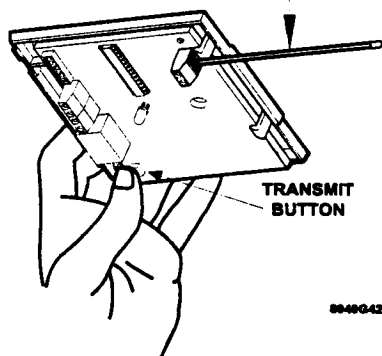
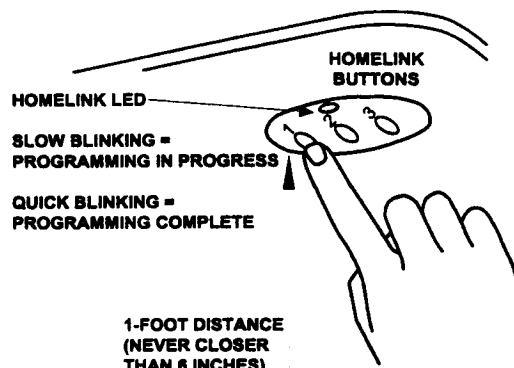

**Figure 4. Pressing the Interface Transmit Button and HomeLink Button 1 Together for Programming**

(The Interface LED should blink quickly, indicating that the Interface is transmitting the signal.)

In approximately 2 to 30 seconds, the HomeLink LED in the vehicle starts blinking slowly, indicating it is attempting to learn the Interface signal.

- 3) Keep both buttons pressed and maintain the position of the Interface until the HomeLink LED in the vehicle blinks quickly for at least 3 seconds, indicating it has learned the Interface signal. Now you can release the buttons.

**Note:** If the HomeLink does not learn the Interface signal, the HomeLink LED stops blinking slowly after 90 seconds. If this occurs repeat steps 2 and 3, this time holding the Interface **three inches closer** to the HomeLink buttons.

## Program HomeLink Button 2

- 1) Set the Interface DIP switch to:



- 2) Repeat steps 2 and 3 as described for HomeLink button 1, but this time press HomeLink button 2.

## Program HomeLink Button 3

- 1) Set the Interface DIP switch to:

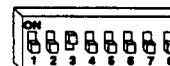

- 2) Repeat steps 2 and 3 as described for HomeLink button 1, but this time press HomeLink button 3.

## Verify HomeLink Button Programming

- 1) Set the Interface DIP switch to:



- 2) Press HomeLink button 1 for one to two seconds. The Interface LED should produce **one** short series of rapid blinks.
- 3) Press HomeLink button 2 for one to two seconds. The Interface LED should produce **two** short series of rapid blinks.
- 4) Press HomeLink button 3 for one to two seconds. The Interface LED should produce **three** short series of rapid blinks.
- 5) If one of the HomeLink buttons does not cause the Interface LED to blink, that button must be reprogrammed (see previous section).

## Add the Interface to Control Panel Memory

Before the Interface can communicate with the control panel, the Interface ID must be added to panel memory as a wireless touchpad.

**Note:** For Quik Bridge Loop Receivers, see the next section, "Using the Quik Bridge Loop Receiver with the Interface."

- 1) Using the specific panel's installation instructions or reference manual, put the security system panel in program mode for learning wireless touchpads.
- 2) Set the Interface DIP switch to:

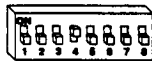

The LED should blink slowly.

- 3) Press the Interface transmit button. The panel should indicate that the touchpad has been programmed.

**Note:** CareTaker Plus, UltraGard, and Security Pro 4000 and 5000 panels require that all wireless touchpads be relearned when a new wireless touchpad is added.

## Using the Quik Bridge Loop Receiver with the Interface

Set up the Quik Bridge Loop Receiver with the Interface using the installation instructions (part number 466-1127), included with the Loop Receiver. Refer to the section titled "Learning Wireless Transmitters" and use the procedure for keychain touchpads.

The Interface sends the same signals as keychain touchpad buttons. Table 5 in this document shows the keychain touchpad button signals generated by the Interface when HomeLink buttons are pressed.

For example, to set up the Interface and Loop Receiver to arm and disarm a system with a maintained keyswitch arming input, follow these steps:

- 1) Set Loop Receiver zone 2 into the learn mode.
- 2) Set the Interface DIP switches to the first entry shown in Table 5.
- 3) Press HomeLink button 1 inside the vehicle. This causes the Interface to transmit a 'lock' signal that the Loop Receiver learns into zone 2.
- 4) With the Loop Receiver's zone 2 output connected to the security system panel's keyswitch arming input, HomeLink buttons 1 and 2 now arm and disarm the system.

After setting up the Loop Receiver with the Interface, skip the next section and proceed to "Mount and Wire the Interface."

Remember to fill in the "Owner Information Sheet" at the back of these instructions and *give the sheet to the homeowner* so they have a record of their HomeLink button functions.

## Assign the HomeLink Button Functions

The Interface DIP switch setting determines how the security system responds to HomeLink button presses. Tables 2 through 6 describe the DIP switch settings and corresponding button functions for the compatible security systems.

**Note:** Remember, HomeLink buttons not programmed with an Interface signal won't provide the response described in Tables 2 through 6.

Once you have set and tested the DIP switch setting, complete the "Owner Information Sheet" at the back of these instructions and *give the sheet to the homeowner* so they have a record of their HomeLink button functions.





**Note:** The Interface allows multiple functions from a single HomeLink button press. For example, the last DIP switch setting in Table 2 allows the user to open the garage door and disarm the security system by pressing HomeLink button two.

**Table 2. UltraGard, Security Pro 5000, and Security Pro 4000 Panel Responses**

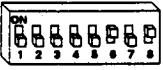
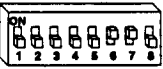
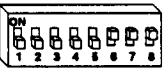
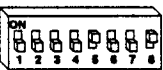

DIP Switch Setting	Response		
	Button 1	Button 2	Button 3
	Arm to next higher level	Disarm to level 1	Activate garage door opener
	Arm to next higher level	Disarm to level 1	Turn lights on/off
	*Arm directly to level 2	Disarm to level 1	Activate garage door opener

(Table 2 continued on next page.)

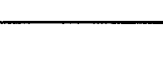
**Table 2. UltraGard, Security Pro 5000, and Security Pro 4000 Panel Responses (continued)**

DIP Switch Setting	Response		
	Button 1	Button 2	Button 3
	**Arm directly to level 3	Disarm to level 1	Activate garage door opener
	Arm to nexthigher level	Turn lights on/off, then Disarm to level 1	Activate garage door opener
	Disarm to level 1	Turn lights on/off	Activate garage door opener
	*Arm directly to level 2	Turn lights on/off, then Disarm to level 1	Activate garage door opener
	**Arm directly to level 3	Turn lights on/off, then Disarm to level 1	Activate garage door opener
	Activate garage door, then Arm to nexthigher level	Disarm to level 1, then activate garage door	Turn lights on/off
	Arm to nexthigher level	Disarm to level 1	Same as owner's keychain touchpad star button
	*Activate garage door, then Arm directly to level 2	Disarm to level 1, then activate garage door	Turn lights on/off
	**Activate garage door, then Arm directly to level 3	Disarm to level 1, then activate garage door	Turn lights on/off

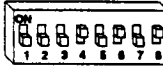
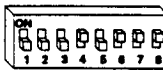
**Table 2. UltraGard, Security Pro 5000, and Security Pro 4000 Panel Responses (continued)**

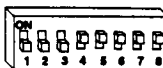
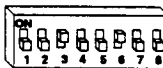
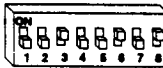
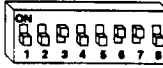
DIP Switch Setting	Response		
	Button 1	Button 2	Button 3
	Activate garage door, then Arm to next higher level	Disarm to level 1, then activate garage door	Turn lights on/off
	Arm to next higher level	Turn lights on, activate garage door, then Disarm to level 1	Activate garage door opener
	Arm to next higher level	Disarm to level 1, then activate garage door	Turn lights on/off
	**Activate garage door, then Arm directly to level 3	Disarm to level 1, then activate garage door	Turn lights on/off
	Arm to next higher level	Disarm to level 1, then activate garage door	Activate garage door opener
	*Arm directly to level 2	Disarm to level 1, then activate garage door	Activate garage door opener
	**Arm directly to level 3	Disarm to level 1, then activate garage door	Activate garage door opener

\*Security Pro 4000 arms directly to level three.  
 \*\*Security Pro 4000 arms directly to level two.

**Table 3. Commander 2000 and Security Pro 2000 Panel Responses**

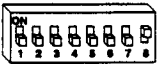
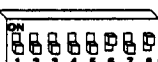
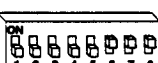
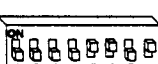
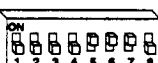
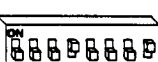
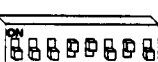
DIP Switch Setting	Response		
	Button 1	Button 2	Button 3
	Arm to next higher level	Disarm to level 1	Activate garage door opener
	Arm to next higher level	Disarm to level 1	Turn lights on/off
	Arm directly to level 3	Disarm to level 1	Activate garage door opener
	Disarm to level 1	Turn lights on/off	Activate garage door opener
	Activate garage door, then Arm to next higher level	Disarm to level 1, then activate garage door	Turn lights on/off
	Arm to next higher level	Disarm to level 1	Same as owner's keychain touchpad star button
	Activate garage door, then Arm directly to level 3	Disarm to level 1, then activate garage door	Turn lights on/off
	Arm to next higher level	Disarm to level 1, then activate garage door	Turn lights on/off

**Table 3. Commander 2000 and Security Pro 2000 Panel Responses (continued)**

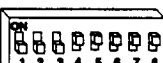
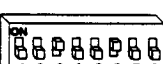
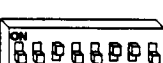
DIP Switch Setting	Response		
	Button 1	Button 2	Button 3
	Activate garage door, then Arm directly to level 3	Disarm to level 1, then activate garage door	Turn lights on/off
	Arm to next higher level	Disarm to level 1, then activate garage door	Activate garage door opener
	Arm directly to level 3	Disarm to level 1, then activate garage door	Activate garage door opener

**Table 4. Simon Panel Responses**

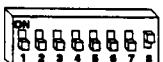
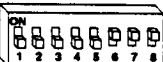
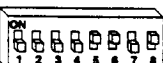
DIP Switch Setting	Response		
	Button 1	Button 2	Button 3
	Arm to next higher level	Disarm security system	Activate garage door opener
	Arm to next higher level	Disarm security system	Turn lights on/off
	Disarm to level 1	Turn lights on/off	Activate garage door opener
	Activate garage door, then Arm to next higher level	Disarm security system, then activate garage door	Turn lights on/off

(Table 4 continued on next page.)

**Table 4. Simon Panel Responses (continued)**

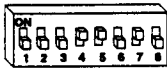
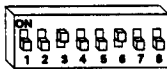
DIP Switch Setting	Response		
	Button 1	Button 2	Button 3
	Arm to nexthigher level	Disarm security system	Same as owner's keychain touchpad star button
	Arm to nexthigher level	Disarm security system, then activate garage door	Turn lights on/off
	Arm to nexthigher level	Disarm security system, then activate garage door	Activate garage door opener

**Table 5. Quik Bridge Loop Receiver Responses (continued)**

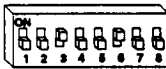
DIP Switch Setting	Response		
	Button 1	Button 2	Button 3
	Lock button	Unlock button, then activate garage door	Activate garage door opener

**Table 6. CareTaker Plus Panel Responses**

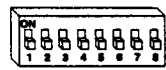
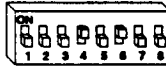
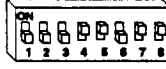
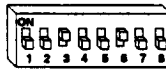
DIP Switch Setting	Response		
	Button 1	Button 2	Button 3
	Arm to nexthigher level	Disarm to level 1	Activate garage door opener
	Arm to nexthigher level	Disarm to level 1	Turn lights on/off
	Arm to nexthigher level	Turn lights on/off, then Disarm to level 1	Activate garage door opener
	Arm to nexthigher level	Disarm to level 1, then activate garage door	Activate garage door opener

**Table 5. Quik Bridge Loop Receiver Responses**

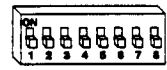
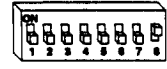
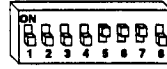
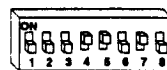
DIP Switch Setting	Response		
	Button 1	Button 2	Button 3
	Lock button	Unlock button	Activate garage door opener
	Lock button	Unlock button	Lights button
	Lock button	Unlock button	Star button
	Lock button	Unlock button, then activate garage door	Lights button

## Mount and Wire the Interface

Use the following guidelines when mounting and wiring the Interface:

- The Interface should be located in the garage where HomeLink signals can reach it.
- If the Interface is used to control the garage door opener, mount the Interface close to the garage door opener button.
- Mount the Interface at least 10 feet from garage door opener control consoles that may cause interference. (These are the large garage door button consoles that contain a radio receiver.)
- Do not mount the Interface on a wall with excessive wiring or foil wallpaper.
- Mount the Interface with the antenna orientation vertically up.
- Allow at least 12 inches above the Interface housing for the antenna.

## Mount the Interface

**CAUTION:** You must be free of static electricity before handling circuit boards. Discharge yourself by touching a bare metal surface, or wear a grounding strap.



- 1) With the cover off, hold the Interface against the mounting surface and mark the wall where the three mounting holes are located.

**Note:** Remember to leave at least 12 inches above the Interface for the antenna.

- 2) Install anchors where needed at marked locations.
- 3) Attach the Interface to the wall with the included screws.

## Connect the Interface to the Garage Door Opener

- 1) Using a 2-conductor, 22-gauge (minimum) stranded wire, connect the relay in parallel with any existing garage door opener button as shown in Figure 5 (the relay is normally open).

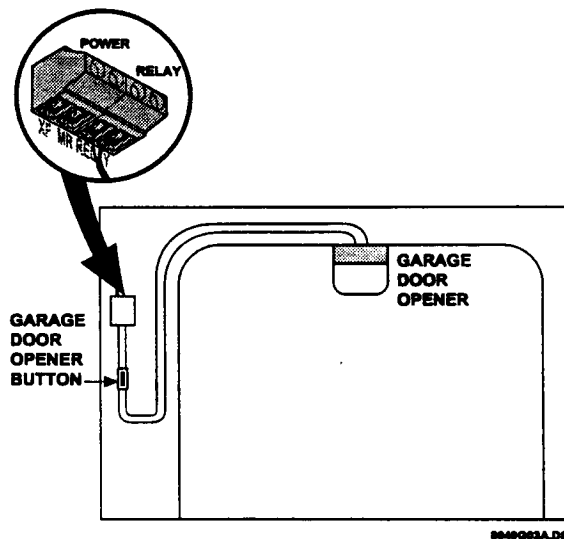

Figure 5. Connecting the Interface to a Garage Door Opener

## Test the System

Test the entire system after mounting the Interface.

- 1) Make sure the Interface is powered up.
- 2) Make sure the Interface DIP switch is set to the desired setting.
- 3) Place the cover on the Interface by aligning the cover at the bottom of the base, then pressing inward at the top until the cover snaps into place.
- 4) Move the vehicle about 100 feet from the garage or to the end of the driveway.
- 5) Press each HomeLink button separately and verify that the security system (and garage door opener) respond according to the assigned setting.

**Note:** If you experience range problems with a particular HomeLink button, *that* button must be reprogrammed. The other HomeLink buttons do not require reprogramming.

To reprogram a HomeLink button, dismount the Interface and repeat the programming steps for *that* button in the section "Program HomeLink Buttons and Verify Programming."



## Connecting the Interface to a Power Supply with Backup Battery (optional)

Figure 6 shows how to connect a power supply with backup battery to the Interface. Polarity does not matter when connecting the power supply DC output to the Interface XFMR input terminals.

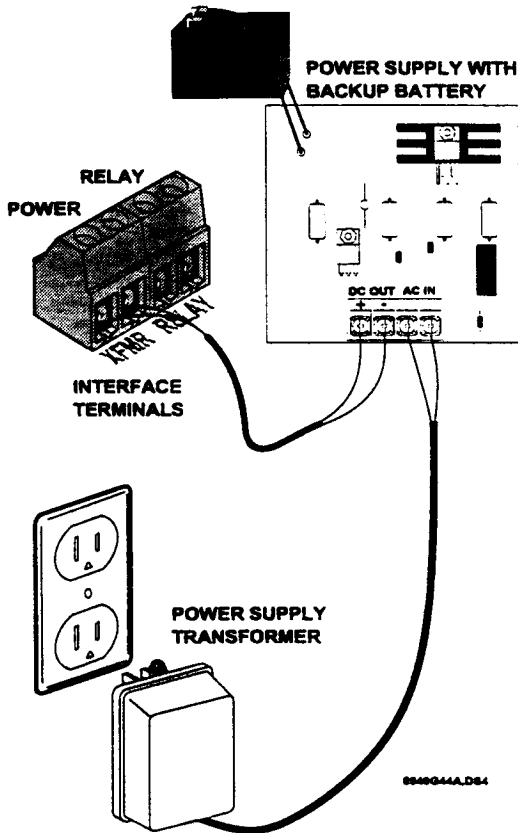

Figure 6. Connecting the Interface to a Power Supply with Backup Battery

## Specifications

**Compatibility:** CareTaker<sup>®</sup> Plus and Security Pro<sup>®</sup> 4000 with software versions 3.0 and later  
 Commander<sup>®</sup> 2000 and Security Pro 2000 with software versions 4.0 and later  
 UltraGard<sup>™</sup> and Security Pro 5000  
 Quik Bridge<sup>™</sup> Loop Receiver  
 Simon<sup>™</sup>

**Power Requirements:** 9-VAC, 15VA Class II transformer, or 12-VDC, 0.5 Amp battery backup power supply

**Relay Contacts:** 6 Amps @ 250-VAC, 120-VDC

**Range:** 150 feet

**Dimensions:** 5.25" x 4.125" x 1.0" (L x W x D)  
 Not including 9.5" antenna.

**Operating Temperature Range:** -30°C to +60°C

Not intended for outdoor use.

## FCC Notices

This equipment has been tested and found to comply with the limits for a Class B digital device, pursuant to Part 15 of the FCC Rules. These limits are designed to provide reasonable protection against harmful interference in a residential installation. This equipment generates, uses, and can radiate radio energy and, if not installed and used in accordance with the instructions, may cause harmful interference to radio communications. However, there is no guarantee that interference will not occur in a particular installation. If this equipment does cause harmful interference to radio or television reception, which can be determined by turning the equipment on and off, the user is encouraged to try to correct the interference by one or more of the following measures:

Reorient or relocate the receiving antenna.

Increase the separation between the equipment and receiver.

Connect the equipment into an outlet on a circuit different from that to which the receiver is connected.

Consult the dealer or an experienced radio/TV technician for help.

Changes or modifications not expressly approved by Interactive Technologies, Inc. can void the users' authority to operate the equipment.

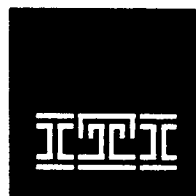

**INTERACTIVE TECHNOLOGIES, INC.**  
2266 SECOND STREET NORTH  
NORTH SAINT PAUL, MN 55109  
T: 612/777-2690  
F: 612/779-4890

WIRELESS

Security

Automation

Access Control

ITI, CareTaker, Commander, and Security Pro are registered trademarks of Interactive Technologies, Inc. UltraGard, Simon, and Quik Bridge are trademarks of Interactive Technologies, Inc. HomeLink is a registered trademark of Prince Corporation.

## Owner Information Sheet

The HomeLink buttons inside your vehicle are programmed to control your security system. The information below has been filled in by your security system installer and describes the function of each button on your vehicle's HomeLink console.

### Your HomeLink Button Functions

The figure below describes the control functions of your HomeLink buttons.

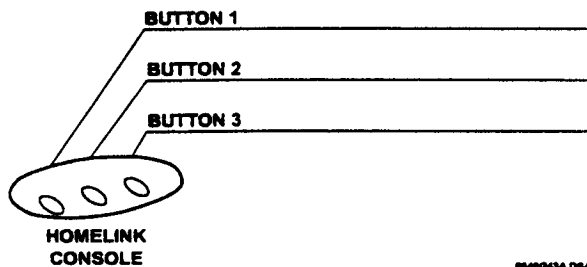

If you decide you want HomeLink button functions changed, your security system installer can do this for you.

## Important Customer Information

The following information describes how operation of your HomeLink buttons may be affected under certain conditions.

- Your security system installer added an interface device to let you control your security system with your vehicle's HomeLink buttons. If the interface was installed without battery backup, the HomeLink buttons will not let you control security system functions during an AC power failure.

Contact your security system dealer if you want battery backup for HomeLink button security system control during power failures.

- If your vehicle is stolen, the HomeLink buttons can still be used to control your security system.

In case of vehicle theft, it is recommended that you contact your security dealer immediately and have them disable the interface device.

# HomeLink® Packaging

current as of 1/13/97

## Competitive Vehicle Analysis

HomeLink® Intro Year	Vehicle Make	Vehicle Model	1996 Packaging
1995	Cadillac	All	Optional on all
1995	Jaguar	XJ6	Option
1995	Lincoln	Town Car	Signature & Cartier
1995	Lincoln	Mark VIII	Option
1995	Mitsubishi	Galant	Std-LS, Opt-ES
1995	Mitsubishi	Spyder	Std-GST, Opt-GS
1995.5	BMW	7 Series	Standard
1995.5	Buick	Riviera	Standard
1995.5	Infiniti	I-30	Leather
1995.5	Oldsmobile	Aurora	Standard
1996	BMW	5 Series	Optional on all
1996	Chrysler	Cirrus	Standard
1996	Chrysler	LHS	Standard
1996	Chrysler	Sebring	LXi
1996	Chrysler	Sebring Convertible	Luxury Group
1996	Dodge	Avenger	Option on ES
1996	Eagle	Talon	TSI AWD-opt
1996	Jeep	Grand Cherokee	Limited Package
1996	Lincoln	Continental	VEMS Package
1996	Mercedes	E-Class	Standard
1996	Mitsubishi	Eclipse	GS, GSX, GST
1996	Nissan	Pathfinder	Std-LE, Opt-SE
1996.5	Oldsmobile	Bravada	Standard
1996.5	Mercedes	S-Class	Standard
1996.5	Mercedes	SL-Class	Standard
1996.75	Infinity	Q45	Standard
1997	Land Rover	Range Rover	4.6 V-8
1997	Chevrolet	Astro Van	Option LS & LT
1997	GMC	Safari Van	Option SLX, SLE & SLT
1997	Buick	Park Avenue	Std.-Ultra, Opt.-all other
1997	Chevy	S-10 Blazer	Std-LT, Opt-LS
1997	GMC	Jimmy	Option
1997	Jaguars	XJS	Option
1997	Land Rover	Discovery	Standard
1997	Mercedes	C-Class	Standard
1997	Mercedes	SLK	Standard
1997	Mitsubishi	3000GT	Std-SL & VR4
1997	Mitsubishi	Diamante	Option ES & LS
1997	Nissan	Maxima	Std-GLE, Option GXE & SE
1997	Ford	Windstar	Option LX

# HomeLink® Program Facts:

---

## Total Number of Models

In the 1997 model year, HomeLink will be available on 44 different vehicle models.

## 1997 HomeLink Programs

Vehicles launching HomeLink in the 1997 model include:\*

- 1 Upper Luxury Vehicles
- 3 Luxury Sport Utilities
- 2 Luxury Sport Vehicles
- 2 Mid Luxury Vehicles
- 2 Lower Luxury Vehicle
- 1 Mid Vans
- 2 Mid Sport Utilities
- 1 Upper Middle Vehicle



**HomeLink®**

**HomeLink Icon Usage**

To date, 26 vehicle models have confirmed that they will be using the HomeLink Icon in the 1997 model year.

\*per Wards Automotive Segmentation



PRINCE