

D9412GV2/D7412GV2



Security Systems

EN | Program Entry Guide
Control Panels

BOSCH

Trademarks

CoBox™ is a registered trademark of Lantronix®.

Windows® is a registered trademark of Microsoft Corporation in the United States or in other countries.

Molex® is a registered trademark of Molex Incorporated.

Documentation Conventions

Type Styles Used in this Manual

To help identify important items in the text, the following type styles are used:

Prompt

A thick border is used to indicate a main programming entry as seen in the Remote Programmer's Display. It is used as a section heading and screen example. Shaded boxes indicate programmer prompts that are only available when Custom or View events are selected.

Sub-Prompt

A dashed border indicates a sub entry under a main programming entry.

Tips, Notes, Cautions and Warnings

Throughout this document helpful tips and notes are presented concerning the entire application or programming the unit. They are displayed as follows:



Important Notes

These notes should be heeded for successful operation and programming.



Warning!

These warn of the possibility of physical damage to the operator, program and/or equipment. Use this when there is an increased risk of physical damage to the operator (severe injury or death) or equipment (destruction of physical components).



Caution

These caution the operator that physical damage to the program and/or equipment.

Table of Contents

1.0	Introduction.....	5	2.11.2	Keypad Selections.....	54
1.1	Using this Program Entry Guide	5	2.11.3	Access Control Functions.....	57
1.2	Product Handlers.....	6	2.11.4	Authority Level Selections	61
1.3	Guide to Programming Options	7	2.11.5	Access Control Levels	69
1.4	Programming the Control Panel with the D5200 Programmer	7	2.12	Function List.....	70
2.0	GV2MAIN.....	9	2.13	Relay Parameters	71
2.1	Phone	9	2.13.1	Area Relays.....	72
2.2	Phone Parameters.....	10	2.13.2	Panel-Wide Relays.....	74
2.3	Routing	13	3.0	RADXUSR1/RADXUSR2	77
2.3.1	Called Party Disconnect	13	3.1	Pass Code or Token Worksheet.....	77
2.3.2	Route Number Groups: Which Has the Highest Priority?.....	13	3.1.1	User Groups.....	77
2.3.3	Programming Primary and Backup Destinations.....	13	3.1.2	Pass Codes	77
2.3.4	Enhanced Routing.....	13	3.1.3	User Group Window	77
2.3.5	Programming a Duplicate Report.....	13	3.1.4	User Name.....	77
2.3.6	Routing Destination Communication Failures.....	14	3.1.5	Tokens and Cards	77
2.3.7	Message Prioritization within a Route Number	14	3.1.6	Reporting and Logging.....	77
2.3.8	Dialing Attempts.....	14	4.0	RADXPNTS.....	81
2.4	Enhanced Routing.....	21	4.1	Point Index	81
2.4.1	Programming a Primary and Backup Destination	21	4.2	Point Responses.....	85
2.4.2	Programming a Duplicate Report.....	21	4.2.1	Applications for Point Responses 9, D, and E:.....	85
2.5	Power Supervision	25	4.2.2	Characteristics of a Fire Point:.....	85
2.6	Printer Parameters	27	4.3	Point Assignments.....	94
2.7	RPS Parameters	28	4.4	COMMAND 7 and COMMAND 9	97
2.7.1	Uploading and Downloading Reports	28	5.0	RADXSKE.....	99
2.7.2	Log Threshold Reports	29	5.1	Windows	99
2.7.3	RPS Callback Reports.....	29	5.1.1	Opening and Closing.....	99
2.8	Miscellaneous.....	31	5.1.2	User Group Windows.....	106
2.9	Area Parameters.....	32	5.1.3	Holiday Indexes for User Group Windows	108
2.9.1	Area Parameters.....	32	5.2	Skeds.....	108
2.9.2	Programming Account Numbers in 9000 Series Control Panels	32	5.3	Holiday Indexes.....	117
2.9.3	Shared-Area Characteristics	37	5.3.1	Add/Change/Delete	117
2.9.4	Bell Parameters	37	5.3.2	View Holidays.....	118
2.9.5	Open/Close Options.....	39	6.0	GV2AUX.....	119
2.9.6	Arming Features	43	6.1	Introduction	119
2.10	Keypad.....	45	6.2	RPS and D5200 Handler Requirements	119
2.10.1	Cmd Cntr (Keypad) Assignment	45	6.3	SDI Automation	119
2.10.2	Area Text.....	50	6.4	SDI RPS Parameters.....	121
2.11	User Interface.....	54	6.4.1	User Interface Modifications for COMMAND 43.....	121
2.11.1	Commands	54	6.4.2	Using an External Modem.....	123
			6.5	Programming Path Numbers and IP Addresses for Enhanced Communications	127
			6.6	SDI RPS/Enhanced Communications Configuration	130
			6.7	Route Group Attempts.....	131
			6.8	Miscellaneous	131

6.9	Cross Point Parameters	132
7.0	RADXAXS	135
7.1	Door Profile	135
7.2	Strike Profile	138
7.3	Event Profile	139
	Programming Prompts Directory	141

Figures

Figure 1:	Pager Display Fields	22
Figure 2:	Account Number Entry	33
Figure 3:	Softkey Locations on the D1260 Keypad	53
Figure 4:	User Group 122 Example	78
Figure 5:	Example Opening Window Timeline (using two Opening Windows on same day)	101
Figure 6:	COMMAND 43 Flow Chart	122
Figure 7:	RPS IP Address Prompts	122
Figure 8:	Com Port Selection within HyperTerminal	124
Figure 9:	External Modem Connection	124
Figure 10:	Path # IP Add1 to Add4	127
Figure 11:	Poll Rate Timeline	128

Tables

Table 1:	Differences between the D9412GV2 and D7412GV2	5
Table 2:	Literature Referenced	5
Table 3:	Product Handlers	6
Table 4:	Programming Error Displays	7
Table 5:	Modem IIIa ² Communication Format Data - User ID Numbers	11
Table 6:	Modem IIIa ² Communication Format Data - Point Numbers	11
Table 7:	Zones	11
Table 8:	Diagnostic Reports	15
Table 9:	Burglar Reports	16
Table 10:	User Reports	16
Table 11:	Test Reports	17
Table 12:	Diagnostic Reports	18
Table 13:	Relay Reports	18
Table 14:	Auto-Function Reports	18
Table 15:	RPS Reports	19
Table 16:	Point Reports	19
Table 17:	User Change Reports	20
Table 18:	Access Reports	20

Table 19:	Event Descriptions, Priorities, and Numbers	23
Table 20:	Programming Four-Digit Account Numbers	32
Table 21:	Programming Ten Digit Account Numbers	33
Table 22:	Verify Time	35
Table 23:	CF### Key Strokes	52
Table 24:	CF### Custom Function Keystrokes	53
Table 25:	Keypad Programming Choices	55
Table 26:	Authority Level Selections	61
Table 27:	L## Secure Door-Door Mode Definitions	65
Table 28:	BSFK User Code Report	78
Table 29:	Bypassing a Point	92
Table 30:	P### BFSK/Relay Codes/Relays	96
Table 31:	Point Text for Points 240 to 247	96
Table 32:	Window Selections	99
Table 33:	Programming for Two Same Day Opening Windows	102
Table 34:	Programming to Link Two Days over Midnight	102
Table 35:	W# Close Window Stop Programming Example	103
Table 36:	Opening and Closing Windows Worksheet	105
Table 37:	Opening and Closing Windows	105
Table 38:	Normal Store Hours	105
Table 39:	Delivery Schedule	106
Table 40:	Monthly Auditor's Schedule*	106
Table 41:	Cross Point Ranges Within Groups	133
Table 42:	Effects of Programming on Custom Function Activation	136

1.0 Introduction

1.1 Using this Program Entry Guide

This guide is only for programming the D9412GV2 and D7412GV2 Control Panels.

Although this guide specifically refers to the D9412GV2 Control Panels, it can be used for programming the D7412GV2 Control Panels. Differences between the D9412GV2 and D7412GV2 are shown in *Table 1*.

Table 1: Differences between the D9412GV2 and D7412GV2

Features	D9412GV2	D7412GV2
Access Control	Eight Doors	Two Doors
Expanded users		
Passcodes	249	99
Cards/tokens	996	396
Passcode-protected custom functions	16	4
Number of printers	3	1
Number of points	246	75
Number of relays	128	64

Table 2: Literature Referenced

Document Name	Part Number
1. <i>D1255 Installation Instructions</i>	74-06819-000
2. <i>D1256/D1257 Installation Instructions</i>	74-06925-000
3. <i>D1260 Installation Guide</i>	48101
4. <i>D1260 Owner's Manual</i>	50410
5. <i>D5200 Operations Manual</i>	74-06176-000
6. <i>D6500 Report Directory</i>	74-04651-001
7. <i>D6600 Communications Receiver/Gateway Computer Interface Manual</i>	39963
8. <i>D720 Installation Instructions</i>	74-06918-000
9. <i>D9210B Operation and Installation Guide</i>	32206
10. <i>D9210B Program Entry Guide</i>	32207
11. <i>D9210B Program Record Sheet</i>	32208
12. <i>D9412GV2/D7412GV2 Operation and Installation Guide</i>	F01U003636
13. <i>D9412GV2/D7412GV2 Program Record Sheet</i>	F01U003635
14. <i>RPS Operations Manual</i>	38849

1.2 Product Handlers

Programming the 9000GV2 Series requires multiple product handlers. The availability of each handler is indicated in *Table 3*. Refer to the specific control panel's release notes to determine the most current handler versions.

Although the handlers shown in *Table 3* can be used to program any of the new control panels, not all of the functions operate. For example, the RADXUSR1 Handler programs users 000 through 124. Even though the handler allows you to program users 100 through 124, the D7412GV2 does not allow the activation of these users.

Product Handler	Compatible Versions	Function	D9412GV2	D7412GV2
GV2MAIN	V1.00 and above	Covers Panel-Wide, Area, Keypad Function List, User Interface, and Relay programming modules.	✓	✓
RADXUSR1	V1.06 and above	Covers passcode and token programming for users 000 through 124 (users 000 through 099 for the D7412GV2).	✓	✓
RADXUSR2	V1.05 and above	Covers passcode and token programming for Users 125 through 249.	✓	N/A
RADXPNTS	V1.06 and above	Covers Point Index and Point Assignment programming for all points.	✓	✓
RADXSKED	V1.04 and above	Covers Open/Close Windows, User Access Windows, Skeds, and Holiday Index programming modules.	✓	✓
GV2AUX	V1.00 and above	Covers SDI Automation, SDI RPS Parameters, Enhanced Communication Parameters, Route Group Attempts, Miscellaneous, and Cross Point Parameters.	✓	✓
RADXAXS	V1.06 and above	Covers the programming parameters for installed D9210B Door Controllers. The program entry guide and program record sheet for this handler come with the D9210B Access Control Module.	✓	✓

1.3 Guide to Programming Options

This guide is set up in a specific order. Related program entries are grouped together in modules as they appear in the specific product handlers. The handler and the programming module are listed at the top of each page to help you find specific programming prompts.

This guide shows the programming options for each product handler. Each option is listed with:

- **The Program Item Prompt:** Each prompt is shown as it appears in the D5200 Programmer [refer to the *D5200 Programmer Operations Manual* (P/N: 74-06176-000)] or the Remote Programming Software (RPS). Refer to the *RPS Operations Manual* (P/N: 38849). For space considerations, some prompts must be abbreviated in the Programmer display. In these cases, the meaning of the prompt is explained below the prompt
- **Program Entry Default Setting:** Because defaults are set for the typical installation, programming each prompt might not be necessary. Review the default entries in the program record sheet shipped with the control panel to determine which prompts must be programmed.
- **Program Entry Selections:** Only the selections listed can be used for a particular program item.
- **Program Entry Description:** Describes the various entry selections. Read the descriptions carefully to avoid improperly programmed equipment.
- **Custom Programming:** Select custom programming (**Yes** or **No**) to expand programming modules within the D5200. Programming Custom as **Yes** allows parameters for special applications to be visible in the programmer.

1.4 Programming the Control Panel with the D5200 Programmer



Caution: Do not connect the D5200 to the PROG connector without closing the reset switch. Doing so causes SDI ## TROUBLE and CALL FOR SERVICE to display on the keypads. Door controllers also activate, depending upon the SDI failure DIP switch setting.

- To connect the D5200 Programmer to the control panel:
 1. Close the reset switch, located in the upper right corner of the control panel and labeled S1 Reset, to place the D9412GV2 or D7412GV2 Control Panel in the standby mode.
 2. Connect the Molex® connector at one end of the cord to the connector labeled PROG on the PCB and PROG CONN on the faceplate.
- To retrieve the current control panel configuration, press the [RECV (COPY)] key on the D5200 at the NEWRECORD prompt. Refer to the *D5200 Programmer Operation Manual* (P/N: 74-06176-000) for detailed information.
- To write new configuration information for the control panel, press the [SEND (LOAD)] key at the NEWRECORD prompt. Refer to the *D5200 Programmer Operation Manual* (P/N: 74-06176-000) for detailed information.
- To disconnect the D5200:
 1. Disconnect the the Molex® connector.
 2. Open the reset switch.



When the reset switch is opened, the control panel reboots and resumes normal operation within 5 to 25 sec.

Table 4: Programming Error Displays

Display	Description
INCOMPATIBLE PANEL	You are connected to the wrong control panel or using the wrong handler. Check the faceplate for the model number and the handler title.
CHECK CORD/RESET PIN	Check the cord and the reset pin

Notes:

2.0 GV2MAIN

Use GV2MAIN programming module to define the operating characteristics that affect panel-wide functions. This module has nine programming categories:

- Phone
- Phone Parameters
- Routing
- Enhanced Communications
- Area Parameters
- Keypad
- User Interface
- Function List
- Relay Parameters.

2.1 Phone

The control panel can dial as many as four different telephone numbers when sending event reports. All telephone numbers use the same receiver format. Refer to *Section 2.3 Routing* on page 13. For information about event report routing and communication protocols.

Phone 1

Default:	Blank
Selection:	Up to 24 characters (do not enter [SPACE])
0 to 9	Numbers 0 through 9
C	Three-second pause
D	Seven-second dial-tone detection
# or *	Used for the same purpose as pressing this key on a telephone keypad when manually dialing. For example, an asterisk (*) may be needed to access your long distance service. Do not use these characters when pulse dialing.
Blank	Control panel dials no phone number. Programming this item Blank does not disable phone routing. To disable reporting to this phone, refer to <i>Section 2.3 Routing</i> on page 13.

This is the telephone number the control panel dials to contact the central station receiver when sending event reports. This number is Phone 1 referred to in the prompts in *Section 2.3 Routing* on page 13.

The control panel is programmed with a seven-second dial tone detect period. When a dial tone is detected or the waiting period ends, the control panel begins to dial. To extend the dial tone detect period, place a D before the phone number. To insert a pause during or after dialing, use C in the number sequence. For example, if the control panel hangs up before it hears the Modem IIIa² Ack tone from the D6500/D6600, program extra Cs after the phone number. The control panel waits on line for three extra seconds for each C programmed.

Enter up to 24 of the characters shown in the *Phone 1* table to define dialing characteristics.



Using both phone-data entry lines: The first line of the phone number data entry line must be filled (twelve characters) before you press [ENTER] to move to the second line. If you enter characters on the second line, and the first line has less than twelve characters, the second line clears when you press [ENTER].

Phone 2

Default: Blank

Selection: Up to 24 characters (do not enter [SPACE])

Refer to the explanation of *Phone 1*. This number is Phone 2, referred to in the prompts in *Section 2.3 Routing*.

Phone 3

Default: Blank

Selection: Up to 24 characters (do not enter [SPACE])

Refer to the explanation of *Phone 1*. This number is Phone 3, referred to in the prompts in *Section 2.3 Routing*.

Phone 4

Default: Blank

Selection: Up to 24 characters (do not enter [SPACE])

Refer to the explanation of *Phone 1*. This number is Phone 4, referred to in the prompts in *Section 2.3 Routing*.

2.2 Phone Parameters

The program items in this category describe panel-wide characteristics for telephone dialing, receiver format, and supervision.

Modem Format

Default: Yes	
Selection: Yes or No	
Yes	Modem IIIa² Communication Format: Reports identify points as 001 through 247 and pass-code User ID codes as 000 through 249 at the D6500/D6600 Receiver (unless <i>Point/User Flag</i> is programmed Yes; refer to the <i>Point/User Flag</i> prompt in this section). When reporting point events, Modem IIIa ² Communication Format also sends point text to the D6500/D6600 as programmed in Point Assignments.
No	BFSK (2300 Hz or 1400 Hz acknowledgment tone).

Central Station Receiver Format for Transmission of Reports: Modem format provides many reporting advantages over the BFSK format. Refer to the *D6500/D6600 Report Directory* (P/N: 74-04651-001) for more information about the effect of reporting formats.



Modem Format must be set to Yes when sending events over a network to a D6600 receiver (NetCom).

If **Modem Format** is No, assign a number to identify Duress Reports in **BFSK Duress Code** (page 12).

Point/User Flag

Default: Yes	
Selection: Yes or No	
Yes	The control panel sends a flag with each report telling the D6500/D6600 to convert point numbers and User ID numbers to COMEX format. Refer to <i>Table 5</i> and <i>Table 6</i> for conversion information. When this parameter is programmed Yes, points and User ID numbers are converted, regardless of the programming of the D6500 or D6600 Receiver for output to the computer system. (Refer to the <i>D6600 Communications Receiver/Gateway Computer Interface Manual, Appendix C, Numbered Table and Note 1</i> .)
No	The control panel does not send the flag. The D6500/D6600 outputs point numbers as 001 to 247 (rather than 100 to 732) and User ID numbers as 000 to 249 (rather than 000 to F08), as indicated in <i>Table 5</i> and <i>Table 6</i> .

This program item determines how point and User ID numbers are presented at the D6500/D6600 display, printer, and computer RS-232 output.

When **Modem Format** is Yes, the control panel sends expanded Bosch Modem IIIa² Communication Format reports to the D6500/D6600. If your central station data files are not set up for point and User ID number reporting, you can use this program item to convert these numbers to COMEX Reports.

When **Modem Format** is Yes, the control panel sends expanded Bosch Modem IIIa² Communication Format Reports to the receiver. **Point/User Flag** affects Bosch Modem IIIa² Communication Format data as shown in *Table 5*. The Bosch Security Systems D6500/D6600 Receiver adds the leading zero in the User ID number with **Point/User Flag** programmed No.

Table 5: Modem IIIa² Communication Format Data - User ID Numbers

Point/User Flag NO	Point/User Flag YES
000	000
001 to 005	001 to 005
006 to 013	601 to 608
014 to 021	701 to 708
022 to 029	801 to 808
030 to 037	B01 to B08
038 to 045	C01 to C08
046 to 053	D01 to D08
054 to 061	E01 to E08
062 to 069	F01 to F08
070 to 249	000

Table 6: Modem IIIa² Communication Format Data - Point Numbers

Point/User Flag NO	Point/User Flag YES
001 to 008	100 to 800
009 to 024	101 to 116
025 to 040	201 to 216
041 to 056	301 to 316
057 to 072	401 to 416
073 to 088	501 to 516
089 to 104	601 to 616
105 to 120	701 to 716
121 to 136	801 to 816
153 to 168	217 to 232
169 to 184	317 to 332
185 to 200	417 to 432
201 to 216	517 to 532
217 to 232	617 to 632
233 - 247	717 to 731

Independent Zone Control Notice: When using Independent Zone Controls (IZC) to send Opening/Closing Reports by point, do not duplicate reporting independent point numbers with User ID Reports (refer to *Section 3.1 Pass Code or Token Worksheet* on page 77). For example: If an IZC is connected to Point 8, do not use User ID 8.

D6000: Opening/Closing User ID numbers are identified at the receiver as ZONES (same identification as independent points).

Table 7: Zones

User ID Number	Zone
1	B
2	C
3	D
4	E
5	F
6	6
7	7
8	8
91	1
92	2
93	3
94	4
95	5
96	0

D6500/D6600 Receiving BFSK Format:

Opening/closing User ID numbers are identified at the receiver as ZN (same identification as independent points). The ZN numbers are based on the tens digit of the User ID number. This applies only for Users 000 through 099. Users 100 through 249 do not report in BFSK format.

DTMF Dialing

Default:	Yes
Selection:	Yes or No
Yes	Dials the programmed phone number(s) using DTMF.
No	Pulse dialing only.

Use dual-tone multi-frequency (DTMF) to dial the central station receiver phone number(s) for event reports, or to dial the remote programming software (RPS).

Phone Supv Time

Default:	Blank
Selection:	Blank or 10 to 240
Blank	No phone line supervision.
10 to 240	Enter the number of seconds (in 10 second increments) you wish to supervise the phone line. After a faulted phone line restores, it takes the same amount of time to start restoral responses.

Phone line trouble responses: Keypads display SERVC PH LINE # to indicate which phone line failed. The keypad initiates a trouble tone if **Buzz on Fail** is Yes and **CC Trouble Tone** is Yes.

With dual phone lines (using the D928 Module), the restored phone line handles all messages regardless of the phone line's number.

Phone, Trouble, and Restoral Events report when they occur. They report also when a Diagnostic Report is initiated from a keypad or by a Sked.

Alarm On Fail

Default:	No
Selection:	Yes or No
Yes	Generate alarm responses when a phone line fails.
No	Phone failures report as trouble responses for Area 1 or the account number associated with Area 1.



Phone Supv Time must be programmed to use this feature.

Phone Failure Alarm Responses: The Alarm Bell relay for Area 1 activates. All Phone Event messages report as Area 1 and the account number for Area 1.

Buzz on Fail

Default:	No
Selection:	Yes or No
Yes	Generate panel-wide trouble tones and display PHONE FAIL # at keypads when a Phone Fail Event occurs.
No	Does not generate trouble tones at keypads when a Phone Fail Event occurs. PHONE FAIL # still displays.



Phone Supv Time must be programmed to use this feature.

When **Buzz on Fail** is Yes, users can disable the resulting trouble tone on individual keypads by setting **CC# Trouble Tone** to No.

Two Phone Lines

Default:	No
Selection:	Yes or No
Yes	The D928 Dual Phone Line Module is installed. The LEDs on the D928 light to indicate primary or secondary line trouble and COMM FAIL.
No	D928 Dual Phone Line Module is not installed.



Program **Phone Supv Time** when using two phone lines.

BFSK Duress Code

Default:	0
Selection:	0 to 9

If **Duress Enable** in Area Parameters is Yes and **Modem Format** in Phone Parameters is No, you must program a number to identify Duress Reports at the central station.

Expand Test Rpt

Default:	No
Selection:	Yes or No
Yes	Off-normal events listed in Routing Group Test Reports are reported to the central station.
No	Off-normal conditions for the events listed in the Routing Group Test Reports at test time are not reported.

Use this program item to add system event information to scheduled Test Reports. Refer to *Section 5.2 Skeds* on page 108.

	This parameter relates to Sked Function Code 9 (Test Report) because it allows a Sked to send Expanded Test Report information. Expand Test Rpt does not affect Sked Function Codes 28 (Expanded Off-Normal Test Report) and 29 (Non-Expanded Off-Normal Test Report).
---	--

2.3 Routing

Use routing to select full or partial groups of events that report to up to four different destinations. Routing includes choosing the most important destination (route number), reporting the events to a single or multiple destination, and selecting a backup destination if the events fail.

2.3.1 Called Party Disconnect

Telephone companies provide called party disconnect to allow the called party to terminate a call. The called party must go on hook (hang up) for a fixed interval before a dial tone is available for a new call. This interval varies with telephone company equipment. D9412GV2/D7412GV2 firmware allows for called party disconnect by adding a 35-second on-hook interval to the dial-tone detect function. If the control panel does not detect a dial tone in seven seconds, it puts the phone line on hook for 35 seconds to activate called party disconnect. The phone line goes off hook and begins a seven-second dial tone detect. If no dial tone is detected, the control panel dials the number anyway. Each time the number is dialed, the control panel records this as an attempt. After ten attempts, the control panel enters communications failure and `Comm Fail Route #` appears on the keypads.

2.3.2 Route Number Groups: Which Has the Highest Priority?

To program a group, first choose a route number. The lower the route number, the higher priority that group has (for example, events reported for Route 1 have a higher priority than Routes 2, 3, or 4 if each group tries to send a message at the same time). The priority of the route numbers becomes important when programming duplicate reports or choosing the events you want to report first regardless of the number of events that must report to multiple groups. Route 1 group primary device is the first destination the control panel attempts to dial if an event in that group must be reported. If the control panel is idle, any event generated for any group starts a dialing sequence.

2.3.3 Programming Primary and Backup Destinations

Each route number has an **R# Primary Device** and an **R# Backup Device**. In typical applications where two phone numbers are programmed, the **R# Primary Device** destination is the phone number that the route group attempts to dial first. If the **R# Primary Device** destination does not connect to the central station receiver after two dialing attempts, the control panel dials the **R# Backup Device** destination.

You can also program the control panel so that the **R# Primary Device** or the **R# Backup Device** uses an SDI device, such as a D4020 Network Interface Module. You can program the control panel to make only one attempt for the **R# Primary Device** before attempting to send events using the **R# Backup Device**.

2.3.4 Enhanced Routing

The D9412GV2 and D7412GV2 allow events to be sent to up to four additional SDI Paths. The network interface module (NIM) connects directly to the SDI Bus and occupies SDI Address 88. For additional information regarding the specific programming requirements for enhanced communications, refer to *Section 2.4 Enhanced Routing* on page 21 and *Section 6.5 Programming Path Numbers and IP Addresses for Enhanced Communications* on page 127.

2.3.5 Programming a Duplicate Report

Select **Yes** for each available route number to allow an event within a group to send a report to multiple groups. For instance, if fire alarms are programmed for Route Group 1 and Route Group 2, a fire alarm sends a report first to Route Group 1, followed by a duplicate report to Route Group 2.

2.3.6 Routing Destination Communication Failures

When the **R# Primary Device** fails to connect with the central station after one or two attempts (refer to **RG# 1 Attempt** in *Route Group Attempts* on page 131), it then attempts to connect with the **R# Backup Device** (phone number or SDI Path). The central station receives the original event with a COMM FAIL PHONE# = (1, 2, 3, or 4) event modifier, if the **R# Primary Device** destination is a phone number.

If the **R# Primary Device** is an SDI Path, the central station receives the original event with a COMM FAIL RG# SDI## (SDI Path 1 = 88, SDI Path 2 = 89, SDI Path 3 = 90, SDI Path 4 = 91) event modifier. When all attempts to both the **R# Primary Device** and **R# Backup Device** fail, a Comm Fail RG# Event is generated. Comm Restore Events are not generated.

2.3.7 Message Prioritization within a Route Number

The D9412GV2/D7412GV2 Control Panels meet the digital reporting requirements for UL 864. Fire Alarm Events have the highest priority and reports are sent first for each group. Other events are sent in the following order: Panic, Duress, Medical, Intrusion Alarm, Supervisory, and all troubles and restorals.



To comply with NFPA and UL864, you must program Route 1 to send a report of only Fire Alarm Events to ensure the fastest reporting time.

2.3.8 Dialing Attempts

The D9412GV2 and D7412GV2 Control Panels have an **RG# 1 Attempt** prompt (refer to *Route Group Attempts* on page 131).

If **RG# 1 Attempt** is set to **No**, the control panel makes up to six dialing attempts using the primary device within a route group. If unsuccessful, it makes up to four dialing attempts using the backup device before initiating a Comm Fail Report. When only one destination is programmed, the control panel makes ten attempts to contact that destination. Each group takes approximately 10 minutes to go into Comm Fail.

If **RG# 1 Attempt** is set to **Yes**, the control panel makes only one attempt to contact the primary device before attempting to contact the backup device. The route group still makes a total of ten attempts; however, the **R# Primary Device** makes five attempts and then the **R# Backup Device** makes five attempts.

Route

Default:	1
Selection:	1 to 4
1	First group sent
2	Second group sent
3	Third group sent
4	Fourth group sent

Enter the number specifying the route group to program. The route represents the group you wish to send a group of reports. Group 1 is the first group to send a report and Group 4 is the last group to send a report. Each group has a primary and a backup device. The primary device is the first (most important) destination used to reach the programmed route within this group. The backup device is used if the primary device fails.

R# Primary Device

Default:	Blank
Selection:	Blank, 1 to 4
1	Phone 1 or SDI Path 1 is this group's primary destination.
2	Phone 2 or SDI Path 2 is this group's primary destination.
3	Phone 3 or SDI Path 3 is this group's primary destination.
4	Phone 4 or SDI Path 4 is this group's primary destination.

Enter the number specifying the primary device.

R# Backup Device

Default:	Blank
Selection:	Blank, 1 to 4
1	Phone 1 or SDI Path 1 is this group's backup destination if the primary destination fails.
2	Phone 2 or SDI Path 2 is this group's backup destination if the primary destination fails.
3	Phone 3 or SDI Path 3 is this group's backup destination if the primary destination fails.
4	Phone 4 or SDI Path 4 is this group's backup destination if the primary destination fails.

Enter the number specifying the backup device. The backup device is used when the primary device fails to reach the programmed destination.

View Events?

Default:	No
Selection:	Yes or No
Yes	Access each routing group and program individual events for this route group only (D5200).
No	Continue programming without viewing individual groups.

The D5200 Programmer reveals the following sub-prompts. Leaving **View Events?** as **No** allows the user to ignore a large area of programming that might not need to be changed.

Fire Reports

Selecting **Yes** enables a report to be sent when the event occurs.

Table 8: Diagnostic Reports

Report	Selections	Report Description
R# Fire Alarm	Yes, No	Fire Event
R# Fire Restore (Alarm)	Yes, No	Fire restoral from alarm
R# Fire Missing	Yes, No	Missing Fire point
R# Fire Trouble	Yes, No	Fire trouble
R# Fire Supervis	Yes, No	Fire supervision
R# Fire Restore (T/M/S)	Yes, No	Fire restoral from trouble, missing, or bypass
R# Fire Cancel	Yes, No	Canceled fire alarm
R# Fire Sup Miss	Yes, No	Fire supervisory missing
R# Fire Supv Rest *	Yes, No	Restorals from Fire Supervision

* This event is not reported when using BFSK format.

Burglar Reports

Select **Yes** to send a report when the event occurs.

Table 9: Burglar Reports

Report	Selections	Report Description
R# Alarm	Yes, No	Burglar Alarm Event
R# Burg Restore	Yes, No	Non-fire restoral from trouble, missing, or supervisory
R# Duress	Yes, No	Duress
R# Missing Alarm	Yes, No	Missing Alarm point
R# Usr Code Tmpr	Yes, No	User code tamper
R# Trouble Rpt	Yes, No	Trouble Event
R# Missing Trbl	Yes, No	Missing Trouble Event
R# Non Fire Suprv	Yes, No	Non-fire Supervision Event
R# Pt Bus Fail	Yes, No	Point bus failure
R# Pt Bus Rstl	Yes, No	Restoral of point bus after failure
R# Non Fire Cncl	Yes, No	Canceled non-fire alarm
R# Alarm Restore	Yes, No	Non-fire restoral from alarm
R# Sup Missing	Yes, No	Supervisory missing
R# Unverified Evt*	Yes, No	Unverified Events for Cross Points

* **R# Unverified Evt** is not reported when using BFSK format. Additionally, this event does not produce a corresponding Restoral event.



R# Unverified Evt is sent when a single point programmed in Cross Point Group faults into an alarm condition, then restores before the Cross Point Time elapses.

R# Unverified Evt encompasses both Fire and Non-fire points, but is not related to the **A# Verify Time** used for smoke detectors.



The 9000GV2 Series control panels log a Ground Fault Event as Trouble Point 256.



Restoral Reports are not sent if the control panel resets after a point is bypassed and then unbypassed. This is true for both Fire and Non-fire points.

User Reports

Selecting **Yes** enables a report to be sent when the event occurs.

Table 10: User Reports

Report	Selections	Report Description
R# Point Bypass	Yes, No	Point Bypass Event
R# Forced Point	Yes, No	Forced Point Event
R# Point Open	Yes, No	Point Opening Event
R# Point Close	Yes, No	Point Closing Event
R# Forced Arm	Yes, No	Point Force Armed
R# Fail To Open	Yes, No	Fail to Open Event
R# Fail To Close	Yes, No	Fail to Close Event
R# Ext Clos Tm	Yes, No	Extend Close Time Event
R# Opening Rpt	Yes, No	Opening Events
R# Forced Close	Yes, No	Point Forced Close Event
R# Closing Rpt	Yes, No	Closing Events
R# FC Perim Inst	Yes, No	Forced Close Perimeter Instant Armed Event
R# FC Perim Delay	Yes, No	Forced Close Perimeter Delay Armed Event
R# Perim Inst Arm	Yes, No	Perimeter Instant Armed Event
R# Perim Delay Arm	Yes, No	Perimeter Delay Armed Event
R# Send User Text	Yes, No	User text

Test Reports

To send a single Test Report (**R# Test Report**), enable Sked Function Code #9 (Test Report) in the Skeds section of the program. Refer to *Table 11*.

To expand this Test Report to include any off-normal point condition or other off-normal conditions of events listed in Diag Reports as a Non-status Event following a Test Report, **Expand Test Rpt** in *Section 2.2 Phone Parameters* on page 10 must be programmed **Yes**. Refer to *Table 12* on page 18.

Events R# Log Threshold, R# Log Overflow, and R# RPS Fail are added to the reports sent with Expanded Test Reports if **RPS Reports** and **Expand Test Rpt** are enabled.

To initiate a Status Report that includes all R# S: _____ Events as a Status Event, Sked Function Code #10 must be enabled in the Skeds section of the program.

Sending off-normal conditions as a Status Report following a Test Report is required by some automation systems. Sending off-normal conditions as a Non-status Report that follows a Test Report is required for other automation systems.

An off-normal condition is any point that is missing, trouble, supervisory, or in alarm. Also, points not cleared at the keypad report as off-normal.

The control panel can generate an Expanded Off-Normal Test Report by using Sked Function Code 28 or a Non-Expanded Off-Normal Test Report using Sked Function Code 29. To generate this event, one or more points must be in an off-normal state at the time the Sked executes. Expanded Off-Normal Test Reports include the Off Normal Test Report Event as well as events for any points that are in an off-normal state at the time the report is generated. Non-Expanded Off-Normal Test Report Events are sent only when a point is in the off-normal state but sends only the Off-Normal Test Report Event.

Table 11: Test Reports

Report	Selections	Report Description
R# S: Alarm	Yes, No	Status Alarm
R# S: Trouble	Yes, No	Status Trouble
R# S: Supervised	Yes, No	Status Supervised
R# Status Report	Yes, No	Status
R# S: Open	Yes, No	Status Open
R# S: Close	Yes, No	Status Close
R# Test Report	Yes, No	Test
R# S: Perim Inst	Yes, No	Status Perimeter Instant Arm
R# S: Perim Delay	Yes, No	Status Perimeter Delay Arm
R# S: Fire Supv	Yes, No	Status Fire Supervision
R# S: Fire Alarm	Yes, No	Status Fire Alarm Report
R# S: Fire Trbl	Yes, No	Status Fire Trouble
R# S: Msng Fire	Yes, No	Status Fire Missing
R# S: MsngBurgTr	Yes, No	Status Burg Missing Trouble
R# S: MsngBurgAl	Yes, No	Status Burg Missing Alarm
R# S: FireSpMsng	Yes, No	Status Fire Supervision Missing
R# S: SuperMsng	Yes, No	Status Non-fire Supervision Missing
R# S: DrLeftOpen	Yes, No	Status Door Left Open

Diag Reports

Selecting **Yes** enables sending a report when the event occurs. If the off-normal state of the following events (indicated with an *) still exist, they report when a Test Report (refer to the **Test Reports** sub-prompt in *Section 2.3.8 Dialing Attempts* on page 14) is enabled and Expanded Test Rpt is programmed **Yes**.

Table 12: Diagnostic Reports

Report	Selections	Report Description
R# SDI Dev Fail*	Yes, No	SDI device failure
R# SDI Dev Restl	Yes, No	Restoral of SDI device failure
R# Watchdog Rset	Yes, No	Watchdog Reset Event
R# ParaChksmFail	Yes, No	Parameter checksum failure
R# Reboot	Yes, No	Reboot Event
R# Ph Line Fail*	Yes, No	Failure of phone line
R# Ph Line Rstl	Yes, No	Restoral of phone line after failure
R# AC Fail*	Yes, No	Failure of AC power to control panel
R# AC Restorl	Yes, No	Restoral of AC power to control panel after failure
R# Batt Missing*	Yes, No	Battery Missing Detection Event
R# Battery Low*	Yes, No	Low battery power
R# Battery Rstl	Yes, No	Restoral of battery power to control panel after Missing or Low Event
R# Rt Comm Fail* ¹	Yes, No	Failure to send report to specific route
R# Rt Comm Rstl	Yes, No	Restoral of communication to specific route after a failure
R# Checksum Fail	Yes, No	Checksum Fail Event
R# Network Fail ²	Yes, No	Failure of network
R# Network Rest ²	Yes, No	Restoral of network
R# Network Cond ²	Yes, No	Condition of network

* Indicates an off-normal event.

¹ This event covers Comm Fail Route Group and Comm Fail Phone. If enabled, both events are sent; if disabled, neither event is sent.

² This event is reserved for future use.



Enable Rt Comm Fail and Rt Comm Restore in only one route group.



Enable Rt Comm Fail and Rt Comm Restore in only one route group.

Relay Reports

Selecting **Yes** enables sending a report when the event occurs.

Table 13: Relay Reports

Report	Selections	Report Description
R# Sensor Reset	Yes, No	Sensor Reset Event
R# Relay Set	Yes, No	Relay Set Event
R# Relay Reset	Yes, No	Relay Reset Event



When activating an on-board relay using reomte automation software, the D9412GV2 and D7412GV2 Control Panels log and print the resulting event as:

Relay 250 (Relay A)
Relay 251 (Relay B)
Relay 252 (Relay C)

AutoFunc Reports

The following prompts support customized routing of Auto Function Reports. Selecting **Yes** enables a report to be sent when the event occurs.

Table 14: Auto-Function Reports

Report	Selections	Report Description
R# Sked Executed	Yes, No	Sked Executed Event
R# Sked Changed	Yes, No	Sked Changed Event
R# Execute Fail	Yes, No	Fail to Execute Event

RPS Reports

Selecting **Yes** enables sending a report when the RPS Passcode Event occurs.



RPS Access Fail can indicate a wrong RPS passcode when communicating with the control panel or a valid RPS session was terminated by a means other than a Good-bye or Reset-by command. Remote Reset indicates a Reset-by command issued from RPS, Bad Call to RPS indicates the control panel called RPS but was unable to connect.

Table 15: RPS Reports

Report	Selections	Report Description
R# Log Threshold	Yes, No	Event log threshold reached
R# Log Overflow	Yes, No	Log is full, old events are overwritten
R# Para Changed	Yes, No	RPS Parameter Change Event
R# RPS OK	Yes, No	Successful RPS Access Event
R# RPS Fail	Yes, No	Failed Access RPS Event
R# Remote Reset	Yes, No	Remote Reset Event
R# Program OK	Yes, No	Successful Laptop Access Event
R# Program Fail	Yes, No	Failed Laptop Access Event

Point Reports

Selecting **Yes** enables a report to be sent when the event occurs.

Table 16: Point Reports

Report	Selections	Report Description
R# Service Start	Yes, No	Reorts Service Walk Test Start Event
R# Service End	Yes, No	Service Walk Test End Event
R# Fire Walk St	Yes, No	Fire Walk Start Event
R# Fire Walk End	Yes, No	Fire Walk End Event
R# Walk Test St	Yes, No	Walk Test Start Event for Walk Test and Invisible Walk Test
R# Walk Test End	Yes, No	Walk Test End Event for Walk Test and Invisible Walk Test
R# Extra Point	Yes, No	Extra Point Event
R# Send Point Text*	Yes, No	Point Text
R# RF Low Bat	Yes, No	Low battery conditions for RF points
R# RF Low Bat Res	Yes, No	Low battery restoral conditions for RF points

* Point text is always transmitted when using NetCom applications.

User Chng Reports

Selecting **Yes** enables a report to be sent when the event occurs.

Table 17: User Change Reports

Report	Selections	Report Description
R# Date Changed	Yes, No	Date Change Event
R# Time Changed	Yes, No	Time Change Event
R# Delete User*	Yes, No	Delete User Code Event
R# User Code Chg	Yes, No	User Passcode Add or Change Event
R# Area Watch	Yes, No	Start and end of area watch
R# Card Assigned	Yes, No	Card Assigned to User Event
R# Change Level	Yes, No	Access Control Level Change Event
* With R# Delete User Events, the control panel always uses the account number from Area 1.		

Access Reports

Selecting **Yes** enables a report to be sent when the event occurs.



Access Granted, No Entry, Request to Enter (RTE) and Request to Exit (REX) Events can be enabled or disabled by each D9210B.

Table 18: Access Reports

Report	Selections	Report Description
R# Access Granted	Yes, No	Access Granted Event
R# No Entry	Yes, No	No Entry Event
R# Door Lt Open	Yes, No	Door Left Open Event
R# Cycle Door	Yes, No	Open Door Event
R# Door Unlocked	Yes, No	Unlock Door Event
R# Door Secure	Yes, No	Secure Door Event
R# Door Request	Yes, No	RTE or REX Event
R# Door Locked	Yes, No	Locked Door Event

2.4 Enhanced Routing

Enhanced routing allows the control panels to determine if events are routed over standard telephone lines or a local-area network (LAN) or wide-area network (WAN). Sending events over a LAN or WAN requires a network interface module (NIM), such as the DX4020 or the D9133TTL-E.

Enhanced routing also enables and disables the ability of the control panel to send events to a numeric pager.



If the installation does not require these applications, skip this section.

With enhanced routing, whether you use standard telephone lines or a NIM, you can program the control panel to send full or partial groups of events to as many as four different destinations. Routing includes:

- Choosing the most important destination
- Sending events to a single destination or to multiple destinations
- Selecting a backup destination if events fail.

2.4.1 Programming a Primary and Backup Destination

Each route number has an **R# Primary Device** and an **R# Backup Device**. With enhanced communications, the **R# Primary Device** destination can be either the phone number or the path number for the SDI device, to which the route group first attempts to send the event. If the **R# Primary Device** destination fails to connect to the central station receiver after one or two attempts (refer to **RG# 1 Attempt**), the control panel attempts to connect with the **R# Backup Device** destination.

2.4.2 Programming a Duplicate Report

To send an event within a group to multiple groups, program the event as **Yes** for each route number available. For example, programming fire alarms for Route Group 1 and Route Group 2 sends a fire alarm report first to Route Group 1, followed by a duplicate report to Route Group 2.

Section 2.4 Enhanced Routing on page 21 determines the route groups and which destinations within the route groups use network interface modules (NIMs) for reporting purposes. A single NIM can send events to as many as four different destinations.

For example, if you want to send events using Route Group 1 over a LAN or WAN as your primary destination, and you use a standard telephone line as your backup destination, you must program the following sections:

- Routing (*Section 2.3 Routing* on page 13)
 1. Select Route Group 1
 2. Program a 1 for Primary Destination
 3. Program a 1 for Backup Destination
 4. Enable all applicable events to be included in Route Group 1.
- Phone (*Section 2.1 Phone* on page 9)
 1. Select Phone 1.
 2. Program Phone 1 with the applicable central station receiver phone number.
- Enhanced Routing (*Section 2.4 Enhanced Routing* on page 21)
 1. Enter **Yes** for **RG1 Primary SDI** (Tells the control panel to send the events to the network interface module (NIM) using IP Address 1)
 2. Enter **No** for **RG1 Backup SDI** (Tells the control panel to use the phone line to send events if the primary destination fails after one or two attempts)

Because you are using an SDI Path to send events, you must also program the applicable items in *Section 6.5 Programming Path Numbers and IP Addresses for Enhanced Communications* on page 127.



If you use a network interface module (NIM) as a Primary Device in any of the route groups, follow these programming rules:

- Assign IP Address 1 as the Primary Device in Route Group 1.
- Assign IP Address 2 as the Primary Device in Route Group 2.
- Assign IP Address 3 as the Primary Device in Route Group 3.
- Assign IP Address 4 as the Primary Device in Route Group 4.

The backup device in any route group can use any phone number or IP address number.



If the External Modem feature is used, **RG# Primary SDI** and **RG# Backup SDI** must be set to **No**. The control panel supports either enhanced communication or external modem, but not both at the same time.

RG# Primary SDI

Default: No
Selection: Yes or No

This parameter determines if the primary destination for Route Group 1 (2, 3, or 4) is sent to the NIM

RG# Backup SDI

Default: No
Selection: Yes or No

This parameter determines if the backup destination for Route Group 1 (2, 3, or 4) is sent to the NIM.



To completely disable Enhanced Routing over an SDI path, **RG# Primary SDI**, **RG# Backup SDI**, and **Enhanced Comm** prompts must be set to **No**.



The poll rate entry for the backup SDI path might need to increase because of heavy traffic on the network or excessive signals generated at the same time. All Comm prompts must be set to **No**.

RG# Primary Pager

Default: No
Selection: Yes or No

This parameter determines if this route group sends events to a numeric pager. To send events to a numeric pager, a phone number must also be programmed in the route group's primary destination.



If programming the control panel to dial a numeric pager, choose its route group carefully. Place events being sent to a central station in a route group class with a lower number than the numbers of the events in the route group for the numeric pager.

Numeric Pager Capability

The D9412GV2 and D7412GV2 Control Panels can send most events to a numeric pager. Any time an event is generated and routed to a numeric pager, the control panel calls the numeric pager once for each message in the queue. To enable the pager, program the primary phone number and the backup phone number to the numeric pager's phone number in any of the four route groups. Then select which events to route to the numeric pager within the selected route group.

Up to four event fields can be shown in the pager message. Refer to *Figure 1*.

Figure 1: Pager Display Fields

[1234-001-011-008]

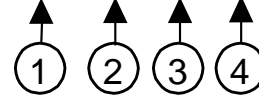

- 1 - Account number (1234)
- 2 - Event policy (001)
- 3 - Event number (011, Fire Alarm Event)
- 4 - User number, point number, or relay number (008)



The account number must contain four numeric digits. No alpha characters (B to F) are allowed when using the numeric pager.

Programming the Pager Phone Number

To program the pager phone number, enter the number used to reach the pager, followed by pauses. Entering C creates a three-second pause (example: 5552341CCC.)

Experiment with the number of pauses you add after the page phone number. Each pause equals 3 seconds. Try calling the pager yourself first and listening to the length of time it takes to get a beep allowing you to enter touch-tone information. This length is what you must program after the pager's phone number in *Section 2.1 Phone* on page 9. If you need a longer pause, enter D after the number. Each D equals seven seconds.

Using “#” characters in the phone number affects the event's display on the pager:

- **No “#” characters in phone number:** Dashes appear in the display [1234-001-011-008].
- **One “#” character in phone number:** Dashes are replaced by zeros [1234000100110008].
- **Two or more “#” characters in phone number:** Dashes appear in the display [1234-001-011-008].

For example, if the phone number 2773074#CC (seven-digit pager phone number followed by “#” and two pauses) is programmed, the pager message appears as follows: [1234000100110008] (dashes are replaced by zeros).

If the “#” is not placed in the phone number, the message appears as follows: [1234-001-011-008]

A user might not want all four fields to show in the pager message. Entering “*” characters in the phone number allows the user to select the number of fields to show in the pager message. To limit the number of fields shown in the pager message, enter the appropriate number of “*” characters in the phone number as shown below:

- **Zero “*” characters in phone number:** Shows all four fields.
- **One “*” character in phone number:** Shows first field only.
- **Two “*” characters in phone number:** Shows first two fields.
- **Three “*” characters in phone number:** Shows first three fields.
- **Four or more “*” characters in phone number:** Shows all four fields.

For example, the phone number 2773074***CC (seven digit pager phone number followed by three asterisks and two pauses) produces the following pager display: [1234-001-011] (three fields display at the pager).

Table 19 shows the description of each event, its priority, and event number.

Table 19: Event Descriptions, Priorities, and Numbers

Event Description	Event Priority	Event Number
Fire Alarm	001	011
Fire Restoral (after Alarm, Supervision)	005	014
Fire Missing	005	013
Fire Trouble	005	012
Fire Supervision	005	124
Fire Restoral (after Tbl, Msg, Bypass)	005	015
Fire Cancel	004	027
Fire Supervision Missing	005	146
Fire Supervision Restore	005	123
Alarm Report	003	016
Burg Restore	006	018
Duress	002	004
Missing Alarm	006	019
User Code Tamper	008	055
Trouble Report	006	017
Missing Trouble	008	020
Non-Fire Supervision	006	078
Point Bus Fail	006	024
Point Bus Restoral	006	091
Non-Fire Cancel	004	045
Alarm Restore	006	026
Supervision Missing	008	147
Unverified Event	006	169
Point Bypass/Command Bypass	007	007
Forced Point	007	008
Point Opening	008	021
Point Closing	008	022
Was Force Armed	007	034
Fail To Open	008	040
Fail To Close	008	041
Extend Close Time	008	044
Opening Report	008	047
Forced Close	007	048
Closing Report	008	050

Table 19: Event Descriptions, Priorities, and Numbers, continued

Event Description	Event Priority	Event Number
Forced Close Perim Instant	007	084
Forced Close Perim Delay	007	085
Perimeter Instant Armed	008	088
Perimeter Delay Armed	008	089
Send User Text	n/a	n/a
S: Alarm	n/a	n/a
S: Trouble	n/a	n/a
S: Supervision	n/a	n/a
Status Report	008	035
S: Open	n/a	n/a
S: Close	n/a	n/a
Test Report	008	051
S: Perimeter Instant	n/a	n/a
S: Perimeter Delay	n/a	n/a
S: Fire Supervision	n/a	n/a
S: Fire Alarm	n/a	n/a
S: Fire Trouble	n/a	n/a
S: Missing Fire (Trouble)	n/a	n/a
S: Missing Burglary ((Trouble)	n/a	n/a
S: Missing Burglary (Alarm)	n/a	n/a
S: Fire Supervision Missing	n/a	n/a
S: Burglary Supervision Missing	n/a	n/a
S: Door Left Open	n/a	n/a
SDI Device Failure*	004	070
SDI Device Restoral*	008	071
Watchdog Reset	004	077
Parameter Checksum Fail	n/a	n/a
Reboot	008	082
Phone Line Fail	004	068
Phone Line Restoral	008	069
AC Failure	004	072
AC Restoral	008	073
Battery Missing	004	074
Battery Low	004	075
Battery Restoral	008	076
Route Comm Fail	004	066
Route Comm Restore	008	067
Checksum Fail	n/a	n/a
Sensor Reset	007	031
Relay Set	007	032
Relay Reset	007	033
Sked Executed	007	057
Sked Changed	007	058
Fail to Execute	008	151
Event Log Threshold	008	052
Event Log Overflow	008	053

* SDI Device number is not reported when using pager format.

Table 19: Event Descriptions, Priorities, and Numbers, continued

Event Description	Event Priority	Event Number
Parameters Changed	008	054
RPS Access OK	008	064
RPS Access Fail	008	065
Remote Reset	008	079
Program Access OK	n/a	n/a
Program Access Fail	n/a	n/a
Service Start	008	029
Service End	008	030
Fire Walk Start	008	036
Fire Walk End	008	037
Walk Test Start	008	038
Walk Test End	008	039
Extra Point	008	023
Send Point Text	n/a	n/a
RF Low Battery	006	093
RF Battery Restore	006	094
Date Changed	008	059
Time Changed	008	060
Delete User	008	090
User Code Change	008	056
Area Watch	008	042
Card Assigned	008	110
Change Level	007	061
Access Granted	008	003
No Entry	008	115
Door Left Open	008	116
Cycle Door	008	112
Door Unlocked	008	113
Door Secure	008	114
Door Request	008	117
Door Locked	008	145
User Alarm COMMAND 7	002	005
User Alarm COMMAND 9	002	006

2.5 Power Supervision

AC Fail Time

Default: 1

Selection: 1 to 90 (Blank and 0 are invalid)

Program the amount of time that AC power must be off before the control panel responds to the AC failure. The response to restoral of AC power is delayed for the same amount of time. The control panel always monitors AC.

When you program *AC Fail Time*, if the second digit is:

- 1, 3, 5, 7, or 9 (such as 3, 5, 11, 13, 15, 21, and so on): The *AC Fail Time* interval is in minutes.
- 2, 4, 6, 8, or 0 (such as 2, 4, 6, 10, 12, 20, 22, and so on): The AC Fail Time interval is in seconds.



For the following items to be true, *AC Fail/Res Rpt* must be programmed as **Yes** and *AC Tag Along* must be programmed as **No**.

When you program *AC Fail Time*, if the second digit is:

- **1, 3, or 5 (such as 3, 5, 11, 13, 15, 21, and so on):** The AC Fail Time interval is in minutes and an AC Fail Event is sent after the loss of AC for this amount of time. No additional AC Fail Events are sent after 6 hours or 12 hours.
- **2, 4, or 6 (such as 2, 4, 6, 12, 14, 16, 22, 24, 26, and so on):** The AC Fail Time interval is in seconds and an AC Fail Event is sent after the loss of AC for this amount of time. No additional AC Fail Events are sent after 6 hours or 12 hours.
- **7 (such as 7, 17, 27, 37, and so on):** The AC Fail Time interval is in minutes and an AC Fail Event is sent after the loss of AC for this amount of time. An additional AC Fail Event is sent after 6 hours if the AC Fail condition is still present.
- **8 (such as 8, 18, 28, 38, and so on):** The AC Fail Time interval is in seconds and an AC Fail Event is sent after the loss of AC for this amount of time. An additional AC Fail Event is sent after 6 hours if the AC Fail condition is still present.

- **9 (such as 9, 19, 29, 39, and so on):** The AC Fail Time interval is in minutes and an AC Fail Event is sent after the loss of AC for this amount of time. An additional AC Fail Event is sent after 12 hours if the AC Fail condition is still present.
- **0 (such as 10, 20, 30, and so on):** The AC Fail Time interval is in seconds and an AC Fail Event is sent after the loss of AC for this amount of time. An additional AC Fail Event is sent after 12 hours if the AC Fail condition is still present.

For the following items to be true, *AC Fail/Res Rpt* must be programmed as **No** and *AC Tag Along* must also be programmed as **No**.

When you program *AC Fail Time*, if the second digit is:

- **1, 3, or 5 (such as 3, 5, 11, 13, 15, 21, and so on):** The AC Fail Time interval is in minutes. No AC Fail or AC Restoral Events are sent.
- **2, 4, or 6 (such as 2, 4, 6, 12, 14, 16, 22, 24, 26, and so on):** The AC Fail Time interval is in seconds. No AC Fail or AC Restoral Events are sent.
- **7 (such as 7, 17, 27, 37, and so on):** The AC Fail Time interval is in minutes. An AC Fail Event is only sent after 6 hours if the AC Fail condition is still present.
- **8 (such as 8, 18, 28, 38, and so on):** The AC Fail Time interval is in seconds. An AC Fail Event is only sent after 6 hours if the AC Fail condition is still present.
- **9 (such as 9, 19, 29, 39, and so on):** The AC Fail Time interval is in minutes. An AC Fail Event is only sent after 12 hours if the AC Fail condition is still present.
- **0 (such as 10, 20, 30, and so on):** The AC Fail Time interval is in seconds. An AC Fail Event is only sent after 12 hours if the AC Fail condition is still present.

To eliminate AC Reporting, **AC Tag Along** and **AC Fail/Res Rpt** must be programmed as **No** and the second digit of the AC Fail Time must be a 1, 2, 3, 4, 5, or 6.

AC Fail/Res Rpt

Default:	No
Selection:	Yes or No
Yes	Send AC Fail and AC Restoral Reports.
No	Does not send AC Fail and AC Restoral Reports.

AC Power Supervision Reports are sent to the central station and local printer at the time programmed for **AC Fail Time**.

To comply with NFPA standards and UL 864 requirements for commercial fire systems, program this item as **No** and program **AC Tag Along** as **Yes**. AC Restoral Reports are not sent.

AC Tag Along

Default:	Yes
Selection:	Yes or No
Yes	Send AC messages as tag along events.
No	Do not send AC messages as tag along events.

Send AC Reports only if any other event occurs while AC is off-normal.

If **AC Tag Along** is set to **Yes** and a subsequent event is generated, the AC Fail Event is sent first, before sending any subsequent events.

AC Tag Along is required for NFPA and UL 864 commercial fire systems. Be sure to program **AC Fail/Res Rpt** as **No** if **AC Tag Along** is programmed **Yes**.

AC/Battery Buzz

Default:	No
Selection:	Yes or No
Yes	Initiates panel-wide trouble tone at all keypads.
No	Does not initiate panel-wide trouble tone at keypads

Initiates a panel-wide trouble tone at keypads when AC fails or battery is low or missing. This program item does not prevent the SERVC AC FAIL or SERVC BATT LOW displays.

To comply with NFPA standards and UL 864 requirements for commercial fire systems, program this item as **Yes**.

De-selecting individual keypads for panel-wide trouble tones: Panel-wide trouble tones for programming the CC Trouble Tone in the keypad parameters to **No** can turn off individual keypads (based on their CC# [1 to 8]).

Bat Fail/Res Rpt

Default:	Yes									
Selection:	Yes or No									
Yes	<p>Battery Failure and Restoral Reports are sent to the central station. They are routed to the telephone number programmed for Power/Phone Events.</p> <table border="0"> <tr> <td>Modem Reports</td> <td>Missing or shorted</td> <td>BATTERY MISSING</td> </tr> <tr> <td></td> <td>Discharged below 12.1 VDC</td> <td>BATTERY LOW</td> </tr> <tr> <td>BFSK Reports</td> <td>Missing, shorted low battery</td> <td>TROUBLE ZONE 9</td> </tr> </table>	Modem Reports	Missing or shorted	BATTERY MISSING		Discharged below 12.1 VDC	BATTERY LOW	BFSK Reports	Missing, shorted low battery	TROUBLE ZONE 9
Modem Reports	Missing or shorted	BATTERY MISSING								
	Discharged below 12.1 VDC	BATTERY LOW								
BFSK Reports	Missing, shorted low battery	TROUBLE ZONE 9								
No	Battery Failure and Restoral Reports are not sent to the central station.									

To comply with NFPA standards and UL 864 requirements for commercial fire systems, program this item as **Yes**.

2.6 Printer Parameters

Up to three D9131A Parallel Printer Interface Modules can be connected to the D9412GV2's (one printer for the D7412GV2's) SDI bus. Each printer is identified by an address of 17, 18, or 19. Options are available for Routing Reports and area assignments.

Printer Address

Default: 17
Selection: 17, 18, or 19 (only 17 is available for the D7412GV2)

Enter the printer address you are programming.

P## Area Assign

Default: 1
Selection: 1 to 8

Assign an area to the printer programmed in **Printer Address**.

P## Supervised

Default:	No
Selection:	Yes or No
Yes	Only one printer can be installed for this P## SDI address.
No	More than one unsupervised printer can be installed using this P## SDI address and the same address DIP switch setting.

Supervise this SDI address. Generate Trouble SDI ## Reports and local trouble annunciation if a problem occurs with this printer or the SDI bus.

- Unsupervised printers sharing the same address setting print the same text.
- Trouble SDI ## Reports are always reported as Area 1, Account 1 Events regardless of where the SDI device is assigned.
- When **P## Supervised** is set to **Yes** and all Printer Event Groups (such as **P## Fire Events**, **P## Burglar Event**, or **P## Usr Chng Evt**) are set to **No**, the control panel does not generate Trouble SDI ## Reports for the printer if the D9131A becomes disconnected.

P## Scope

Default:	No Printer
Selection:	No Printer, Area, Account, Panel Wide, Custom
Panel Wide	Printer prints all designated events that occur panel-wide. A panel-wide printer can cross account boundaries.
Account	Printer prints all designated events that occur within any area with the same account number in which this printer is assigned.
Area	Printer prints all designated events that occur in the area to which this printer is assigned.
Custom	Printer prints all events occurring in areas programmed Yes for this prompt regardless of any boundary restrictions.
No Printer	No printer installed at this address. If a printer is connected, data does not print.

Press the [SPACE] bar to scroll through the selections. Press [ENTER] when the correct selection appears in the display.



The following prompts are visible **only** when you program **P## Scope** to Custom.

P## A1 [through A8] in Scope

Default:	No
Selection:	Yes or No
Yes	Include Area # Events in the scope of this printer.
No	Does not include Area # Events in the scope of this printer.

Only available if **P## Scope** is programmed Custom. This program item determines if events occurring in an area print at this printer.



Refer to the report tables in *Section 2.3 Routing* on page 13 to identify the events that print. Events programmed as **No** in Routing still print at the local printer. Individual events within the report group cannot be suppressed for events printed at the local printer.

P## Fire Events

Default:	Refer to the program record sheet
Selection:	Yes or No
Yes	All events in this group print at assigned printer.
No	No events in this group print at assigned printer.

Use this prompt to determine whether these events print at assigned printer.

P## Burglar Event

Default:	Refer to the program record sheet
Selection:	Yes or No

P## Access Event

Default:	Refer to the program record sheet
Selection:	Yes or No

P## User Event

Default:	Refer to the program record sheet
Selection:	Yes or No

P## Test Event

Default:	Refer to the program record sheet
Selection:	Yes or No

P## Diag Event

Default:	Refer to the program record sheet
Selection:	Yes or No

P## Auto Functions Event

Default:	Refer to the program record sheet
Selection:	Yes or No

P## RPS Event

Default:	Refer to the program record sheet
Selection:	Yes or No

P## Relay Event

Default:	Refer to the program record sheet
Selection:	Yes or No

P## Point Event

Default:	Refer to the program record sheet
Selection:	Yes or No

P## Usr Chng Evt

Default:	Refer to the program record sheet
Selection:	Yes or No

2.7 RPS Parameters

Use these program items to enable remote programming software (RPS) functions in the control panel using the on-board phone connection. Two other methods of remote programming are available (external modem and LAN or WAN connection) using RPS. Refer to *Section 6.4 SDI RPS Parameters* on page 121 for more information on these types of remote programming.

2.7.1 Uploading and Downloading Reports

If the control panel is programmed to send reports in modem format, when RPS contacts the control panel and the passcode is incorrect, the control panel sends an RPS Access Fail Report to the D6500/D6600. RPS Access Fail also occurs when the call is not terminated with either a Good-bye or Reset-bye command.

RPS ACCESS OK is sent according to phone routing when a Good-bye command is entered from RPS to terminate the call.

When a Reset-bye is used to terminate the call, a Remote Reset Report is sent to the D6500/D6600, and an RPS ACCESS OK is placed into the control panel's event log. Reports in the event log that were not sent before the Reset-bye are never sent to the D6500/D6600.

When RPS programming changes parameters, a Parameters Changed Report is sent to the D6500/D6600. If any programming changes are made, perform a Reset-bye.

When RPS contacts the control panel, the RPS passcode and DataLock code are verified. If the control panel's passcode matches and the DataLock code does not, the control panel still generates a RPS Access OK Event; however, the session ends immediately.

To disable remote programming, enter Blank in both *Answer Armed* and *Answer Disarmed* prompts in this section.

2.7.2 Log Threshold Reports

If communication with RPS is unsuccessful, or if no phone number is programmed in **RPS Ph**, the control panel generates Log Threshold and Bad Call to Ram. This indicates the log is filling and the control panel cannot download its events.

If there is no **RPS Ph** programmed, the control panel generates the Log Threshold and Bad Call to RPS Events immediately. Bad Call to RPS Events are logged only locally. If an **RPS Ph** is programmed, the control panel makes multiple attempts to reach RPS before sending the reports. Refer to the **RPS Ph** prompt in *Section 2.7.3 RPS Callback Reports* for an explanation of dialing characteristics.

2.7.3 RPS Callback Reports

When dialing the RPS phone number, the control panel makes two attempts to reach RPS. If the control panel does not reach RPS on the first two attempts, it waits 10 minutes then tries six more times with a 10-minute interval between each attempt. One hour after the last failed attempt, the control panel starts dialing the RPS phone number again. It makes two more attempts then waits 10 minutes and tries six more times with 10-minute intervals between each attempt before generating a Bad Call to RPS Report and abandoning the effort.

Remote Program Dialing Exception: When an RPS phone number is programmed, the user can call RPS by entering [COMMAND][4][3] and pressing the [NEXT] key until CALLRPS? is displayed. Press [ENTER]. Only one attempt is made to contact RPS.

RPS Passcode

Default: 999999
Selection: 0 to 9, A to F
 (six characters required)

Enter six characters. Do not use a space in the passcode.

The control panel verifies the remote programming software at the central station has valid access before connecting using the RPS passcode.

Log % Full

Default: Blank
Selection: 1 to 99, or Blank

This parameter determines how full the memory log can be before initiating a call to RPS at the central station. This allows the central station to call the control panel and copy the memory log before messages are overwritten.

Blank disables the Log Threshold and Log Overflow Events. These events are not entered in the log or reported to the D6500/D6600 or the local printer.

The control panel continues to log events after the Log Threshold Report is sent. When it reaches 100% capacity (memory logger is full and previously stored events are overwritten), the control panel generates a local Log Overflow Event.

The control panel does not call RPS again until it downloads the log and the Log % Full percentage is reached. These events are also sent to the control panel's event log and to the local printer(s) if installed.



The Log Overflow Event is not sent to the central station unless **Expanded Test Rpt** is programmed **Yes**.

RPS Call Back

Default: No	
Selection: Yes or No	
Yes	When the control panel hears the correct RPS passcode, it hangs up the phone, seizes the phone line, then dials the programmed RPS phone number (refer to the RPS Ph prompt in this section). This ensures that the control panel only communicates with RPS units connected to the programmed phone number.
No	The RPS session starts immediately. No call back is required. The control panel can engage in RPS sessions when called from any phone number and a proper RPS passcode is identified.

This function allows the control panel, after it verifies the RPS passcode, to provide an additional level of security by hanging up and dialing the RPS phone number at the central station before allowing any upload or download.

 When using the RPS Call Back feature, be sure to program the character "C" as the last digit in the RPS phone number when using **DTMF Dialing**.

RPS Line Monitor

Default: Yes	
Selection: Yes or No	
Yes	Allows the control panel to communicate with RPS after the answering machine answers the phone.
No	Use No if the control panel does not share the phone line with an answering machine.

This program item enables a control panel that shares a phone line with an answering machine to communicate with RPS at the central station, even though the answering machine answers the phone. You must program **Answer Armed** or **Answer Disarmed**. The control panel must be in the correct armed state.

 Program this item **No** if it causes false seizures of the phone line or if you do not use RPS. This indicates that a device using the same frequency tone is also using the phone line to which the control panel is connected.

 If **RPS Call Back** is programmed **Yes**, the control panel hangs up the phone after the RPS tone and a proper RPS passcode is identified. It then calls the RPS phone number.

Answer Armed

Default: Refer to the program record sheet	
Selection: 1 to 15, or Blank	
Blank	No answer.
1 to 15	The control panel answers the phone after the specified number of rings when all areas are master armed.

Set the telephone ring counter to answer when all areas are master armed. If any area in the control panel is perimeter armed or disarmed, the Answer Disarmed ring counter is used.

 The remote programming software (RPS) considers perimeter armed as a disarmed state.

Answer Disarmed

Default: Refer to the program record sheet	
Selection: 1 to 15, or Blank	
Blank	No answer.
1 to 15	The control panel answers the phone after the specified number of rings when any area in the system is in a perimeter armed or disarmed state.

Set telephone ring counter to answer when any area is in a perimeter armed or disarmed state.

 The RPS considers perimeter armed as a disarmed state.

RPS Ph

Default:	Blank
Selection:	Blank or up to 24 characters
Blank	Control panel does not dial a phone number for RPS.
1 to 24 characters	Enter up to 24 characters to define dialing characteristics.

This is the phone number the control panel dials to contact RPS. The control panel dials the programmed number on **Phone #5 (RPS Ph #)** when any of the following events occur:

- Log % Full threshold is achieved.



If **Log % Full** was programmed with a value (1 to 99) and an RPS phone number is programmed, the control panel dials the RPS phone number when the log threshold is reached. This function is not available in RPS. Do not program **Log % Full** and an RPS phone number at the same time.

- The control panel is contacted by RPS and RPS Call Back is programmed **Yes**.
- The user enters COMMAND 43 and selects the call RPS option from the menu. On the D1255:
 1. Press [COMAND][4][3].
 2. Press [NEXT] until CONTACT RPS? appears, then press [ENTER].
 3. Wait for RPS VIA PHONE? to appear, then press [ENTER].



The control panel tries to contact RPS only once using this method.

Refer to *Section 6.4 SDI RPS Parameters* on page 121 for other corrections methods.



Refer to **Phone 1** in *Section 2.1 Phone*.

2.8 Miscellaneous

Duress Type

Default: 1	
Selection: 1 or 2	
1	<p>Increase the last digit by 1 to generate an alarm. For example, if the passcode is 6123, 6124 activates a duress alarm.</p> <p>If the last digit of the passcode is 0, a duress alarm occurs when the user enters 1 as the last digit of the passcode.</p> <p>If the last digit of the passcode is 9, a duress alarm occurs when the user enters 0 as the last digit of the passcode.</p>
2	<p>Increase the last digit by 2 to generate an alarm. For example, if the passcode is 6123, 6125 activates a duress alarm.</p> <p>If the last digit of the passcode is 8, a duress alarm occurs when the user enters 0 as the last digit of the passcode.</p> <p>If the last digit of the passcode is 9, a duress alarm occurs when the user enters 1 as the last digit of the passcode.</p>

This program item determines if users add one (+1) or two (+2) to the last digit of the passcode. To activate a duress alarm, the user increases the value of the last digit of the passcode when entering it at the keypad.



Duress is enabled in Area Parameters by setting **A# Duress Enable** to **Yes**.



The duress alarm activates when a user enters the duress passcode followed by the termination keys ([ESC] or [ENT]).

Cancel Report

Default:	No
Selection:	Yes or No
Yes	Send Cancel and Fire Cancel Reports according to routing.
No	Do not send Cancel and Fire Cancel Reports.

A Cancel and Fire Cancel Report is created when a passcode is entered to silence an Alarm Bell or a Fire Bell before the bell time expires.

2.9 Area Parameters

This programming module contains three programming categories: Area Parameters, Bell Parameters, and Open/Close Options.

2.9.1 Area Parameters

Area

Default:	1
Selection:	1 to 8

Enter the area number you are programming.

A# Area On

Default:	Yes (Area 1 only)
Selection:	Yes or No
Yes	Enable area.
No	Disable area.

Use this program item to enable or disable the area specified.



Area 1 must be enabled:

- System events such as power and phone supervision do not send a report correctly if Area 1 is disabled.
- When programmed **No**, points assigned to this area do not generate events, show at the keypad when arming and disarming, or send status reports. All user authority in this area is turned off while the area is disabled.

A# Acct Number

Default:	0000
Selection:	For BFSK: 0000 to 0999, 0BBB to 0FFF
	For Modem (four-digit account numbers): 0000 to 9999, BBBB to FFFF
	For Modem (ten-digit account numbers): 0000000000 to 9999999999, BBBBBBBBBB to FFFFFFFFFF

Determines the account number for this area. An account number must be assigned to each active area.

Account numbers are used to group areas together. Each area can have a different account number, or several areas can share the same account number. The control panel uses the account number as a reference for arming and keypad text displays.

BFSK: Only the last three digits are sent. Insert a 0 as the first digit of the account number.
Example: 0 2 3 4.

Modem IIIa²: Enter a four-digit or ten-digit number.

2.9.2 Programming Account Numbers in 9000 Series Control Panels

The GV2MAIN handler can program a four-digit or ten-digit account number for each area.

Programming Four-Digit Account Numbers

To program a four-digit account number (such as 1234) using the D5200 Programmer, you must enter leading 0s (zeroes) for Digits 1 to 6, then enter 1234 into Digits 7 to 10. When 0s are entered for the first six digits (Digits 1 to 6), the 9000 Series Control Panel treats this as a four-digit account number. Refer to *Table 20*.

Table 20: Programming Four-Digit Account Numbers

D5200 Programmer				
A#	Acct#	Dgt	1&2	0 0
A#	Acct#	Dgt	3&4	0 0
A#	Acct#	Dgt	5&6	0 0
A#	Acct#	Dgt	7&8	1 2
A#	Acct#	Dgt	9&10	3 4

The D5200 account number entry shown in *Table 20* appears in RPS as 1234.



Although the D5200 allows the character "A" to be entered into the account, do **not** use this character for the account number.

Any account number digits containing "A" for digits 1 to 6 that were uploaded to and received by RPS are **not** displayed.

If an "A" is sent erroneously to the control panel from the D5200 for any of Digits 1 to 6, correct this by:

- Entering six leading 0s from the D5200 and sending them to the control panel,
or
- Entering six leading 0s from RPS, followed by the four-digit account number, and sending them to the control panel.

Figure 2: Account Number Entry

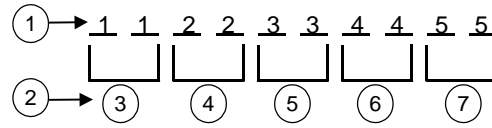

- 1 - RPS account number entry
- 2 - Corresponding D5200 account number digits
- 3 - Digits 1 and 2
- 4 - Digits 3 and 4
- 5 - Digits 5 and 6
- 6 - Digits 7 and 8
- 7 - Digits 9 and 10



Although the D5200 allows the character "A" to be entered into the account, do **not** use this character for the account number.

Programming Ten-Digit Account Numbers

To program a ten-digit account number (such as 1122334455) using the D5200 Programmer, you must enter a character for each of the ten digits. Refer to *Table 21*:

Table 21: Programming Ten Digit Account Numbers

D5200 Programmer				
A#	Acct#	Dgt	1&2	1 1
A#	Acct#	Dgt	3&4	2 2
A#	Acct#	Dgt	5&6	3 3
A#	Acct#	Dgt	7&8	4 4
A#	Acct#	Dgt	9&10	5 5

The D5200 account number entry shown in *Table 21* appears in RPS as shown in *Figure 2*.

A# FA Bypass Max

Default: 1
Selection: 1 to 99

Specify the maximum number of combined Controlled points that can be faulted or bypassed when arming this area.

Refer to the prompts **P## FA Retrnable** and **P## BA Retrnable** in *Section 4.2 Point Responses* on page 85 for returning a point to the system when the point returns to normal or when the area is disarmed.



Users can bypass more points than the number entered here during the disarmed state. It is only when the user attempts to Bypass Arm an area (or areas) that this restriction is enforced.

A# Delay Res

Default: No
Selection: Yes or No

Yes	Point Restoral Report is not sent until the bell time expires or user acknowledges alarm condition.
No	Restoral Reports are sent when point restores, regardless of bell time.

A# Exit Tone

Default: Yes

Selection: Yes or No

Sounds an exit tone during exit delay at all keypads assigned to this area.



You can turn off exit tones for individual keypads by programming the appropriate **CC# 1 to 8** as **No** in **CC# Exit Tone**.

A# Exit Dly Time

Default: 60

Selection: Blank (0) to 600 (in 5 second increments)

Exit delay time for this area when Master Exit or Perimeter Exit arming.



Points programmed for instant alarms generate alarms immediately, even during exit delay. To prevent instant alarms on points when leaving the building, the user must cause a fault. Program **P### Type** in the **Point Index** as 3 (Interior Follower).

A# Auto Watch

Default: No

Selection: Yes or No

Yes	When the area is disarmed, Watch Mode turns on automatically.
-----	---

No	When the area is disarmed, Watch Mode must be turned on or off manually.
----	--



Controlled points must be programmed as **P## Watch Point** to generate a watch tone.

A# Verify Time

Default: 60

Selection: 10 to 60 (in 1-second increments)

Use alarm verification with smoke detectors to reduce the number of false fire alarms. When Verify Time is programmed, the control panel can check smoke detector point activations before generating alarm signals.



- **Do not** enable the Cross Point feature in point indexes designated for Fire points.
- Check with your authority having jurisdiction (AHJ) to determine the maximum verification time allowed.

Points are programmed individually to activate the verification feature. Refer to *Section 4.1 Point Index* on page 81. Any resettable Fire point can activate alarm verification for the area to which it is assigned. Use separate area alarm-verification relays.

To enable alarm verification on a point, program **Point Index**, Fire Point, Alarm Verify, and Resettable as **Yes**.

When an Alarm Verification point senses an alarm, the control panel automatically removes power to all Resettable points connected to the area's Reset Sensors relay. The sensor reset removes power to the sensors for the amount of time programmed in Verify Time. When power is reapplied, a 60-second confirmation window begins. If the detector is still in alarm and experiences another alarm during the confirmation window, or a different Resettable Verification point in the area senses an alarm, an alarm occurs.

Example: Verify Time is set for 20 seconds. The alarm verification cycle starts when the detector senses smoke or fire. No report occurs.

When the detector senses smoke or fire, the area's sensor reset relay interrupts power to points connected to it for the time in Verify Time.

When power restores to the points, the 60-second confirmation window starts. If any detector, reset during the verification time, experiences another alarm during the confirmation window, an alarm occurs. If there is no activity during this period, no alarm occurs and the verification window ends. If a Verification point senses another alarm after the window ends, a new verification cycle begins. Refer to *Table 22* on page 35 for an example of Verify Time.

Table 22:Verify Time

	Verification Point Activation	Verify Time/Reset Sensors	60 second Confirmation	Restart Alarm Verification Cycle if an Alarm Verification point activates.
Example: Total Cycle time 80 seconds		20 Seconds	60 Seconds	

A# Duress Enable

Default:	No
Selection:	Yes or No
Yes	Enable Duress alarm for this area.
No	Disable Duress alarm for this area.





Refer to **Duress Type** in *Section 2.8 Miscellaneous* on page 31 for an explanation of duress.



The passcode you normally use for duress is not valid in an area with **A# Duress Enable** set to **No**.

Set this item as **No** for a particular area and enter a valid duress passcode for that area at the keypad to show NO AUTHORITY.

A# Area Type

Default:	Regular
Selection:	Regular, Master, Associate, or Shared
Regular	Arms or disarms as an independent area.
Master	<p>Does not allow arming for this area unless all associate areas with the same A# account number are master exit delay armed or master armed. CHK AREA displays if the associate areas are not armed. Exception: RPS allows master areas to be armed without all associate areas being in the armed state.</p> <p>A master area can be disarmed regardless of the armed state of the other areas in the account.</p> <p>Multiple master areas can be programmed in a single account.</p> <div style="border: 1px solid black; padding: 5px; margin-bottom: 10px;">  CC# Scope affects master arming. Area: When arming a master area that has CC# Scope set to Area for all keypads, all associate areas within the same account must first be armed independently by other means. Panel Wide or Account Wide: When arming a master area from a keypad with CC# Scope set to Panel Wide or Account Wide, all associate areas enters exit delay as soon as the master area is armed. If there is a shared area within the same account, it begins its exit delay after all associate areas are armed. </div> <div style="border: 1px solid black; padding: 5px;">  Using the arming sked (S## Function 1) requires that you first use an arming sked to arm the associate areas before using an arming sked to arm the master area. Arming master areas with RPS, Keyswitch, or Auto Close parameters (refer to Open/Close Options) occurs before all associate areas are armed </div>
Associate	<p>Allows arming and disarming regardless of the armed state of the other areas with the same A# account number. Use this area type with a master area and associate it by using the same account number.</p> <div style="border: 1px solid black; padding: 5px; margin-top: 10px;">  Keypads assigned to associate areas, when used with shared areas, must have CC# Scope programmed. </div>
Shared	<p>Shared areas cannot be armed using a passcode, key switch, token or card, sked, or RPS.</p> <div style="border: 1px solid black; padding: 5px; margin-top: 10px;">  The scope of all associate areas must include the shared area(s) in order to view faulted points. </div>

2.9.3 Shared-Area Characteristics

Arming a Shared Area

All associate areas must be armed when a shared area is armed. As soon as the last associate area is armed, the shared area automatically begins its arming sequence. Passcode, key switch, sub-controls, or RPS cannot arm shared areas. To display faulted points at associate areas, the shared and associate areas must have the same account number.

Disarming a Shared Area

Shared areas automatically disarm when any associate area in the control panel is disarmed. Passcode, tokens, cards, key switch, sub-controls, or RPS cannot disarm shared areas.

Shared Area Arming Sequence

When shared areas automatically begin to arm, the arming is based on the *A# Exit Dly Time* programmed for the area number where the keypad was assigned.

Shared Area Not Ready

If a point is faulted in the shared area, **CHK AREA** appears on the associate keypad that is arming the last associate area. Associate area keypads can show faults from shared areas as long as the shared areas fall within the scope of the associate area.

Force Arming a Shared Area

When **CHK AREA** appears, press [ESC] to show **FORCE ARM** at the associate keypad. Pressing [ENTER] force arms the shared area if:

- the user has authority to bypass points,
- the point is bypassable, and
- the number of faulted points does not exceed the force arm maximum amount for the shared area.



Remember to include the shared area in the associate area's scope.

Viewing Shared Area Armed Status

View Area Status can be used from a keypad outside of the shared area to view the shared area's armed state.

Silencing Sounders in the Shared Area

Silence shared area alarms and troubles from any keypad.

To silence sounders, the user needs an authority level assigned to the shared area. If the user also has the authority to arm or disarm the area, then **ALREADY ARMED** or **ALREADY DISARMED** momentarily appears.

Access Control Readers Assigned to the Shared Area

The shared area momentarily disarms then begins the exit delay sequence, allowing a user to walk to an associate area and disarm. If the token or card reader assigned to the shared area includes any associate area in the *D## CC# Scope* (in the access handler), both the associate area and shared area disarms when the token or card is presented.

Closing Reports for Shared Areas

If Closing Reports for shared areas are needed, assign passcodes a valid authority level in the shared area.

2.9.4 Bell Parameters

The D9412GV2 and the D7412GV2 have two main types of annunciation: Fire Bell and Burg Bell. Both Fire and Burg Bells share the same terminal (Terminal 6) on the control panel as shipped from the factory.

If a simultaneous Fire Bell and Burg Bell occur, the Fire Bell takes precedence over the Burg Bell regardless of which relay or terminal output they share.

When the Fire and Burg Bells share the same output and a Fire Bell occurs while the Burg Bell is ringing, the Fire Bell pattern overrides the Burg Bell pattern. At the end of the fire time, the burg pattern resumes.

When the Fire and Burg Bells share the same output and a Burg Bell occurs while a Fire Bell sounds, the control panel waits until the Fire time expires before starting the Burg Bell.

Either a single bell (panel-wide) or a number of bells (area-wide) can be used on the control panel. For programming these applications, refer to *Section 2.13.1 Area Relays* on page 72.

When both Fire and Burg Bells occur simultaneously and a user enters a valid passcode, a Fire Cancel Report for the fire alarm and a Cancel Report for the burg alarm is sent to the central station if Cancel Reports is programmed **Yes**.

Area

Default: 1

Selection: 1 to 8

Enter the area number you are programming.

A# Fire Time

Default: 5 minutes

Selection: 1 minute to 90 minutes

Enter the number of minutes the bell rings for Fire Alarm points. The relay activated for this time is programmed in **A# Fire Bell** in Area Relays.

The bell output begins as soon as the fire alarm occurs. It shuts off the bell when the programmed number of minutes expires.

If programmed for 1 minute, the output can be anywhere from 0 to 60 seconds of bell time. Program Fire Time for 2 minutes or more to ensure you have ample output time.



Check with your AHJ to determine the appropriate bell time for your geographical area.

A# Fire Pat

Default: Pulse

Selection: Steady, Pulse, CaStd, TmCod3

Steady	Steady Output
Pulse	Pulse March Time 120 beats per minute, at an even tempo
CaStd	California Standard 10 seconds On + 5 seconds Off + 10 seconds On + 5 seconds Off. This sequence repeats until bell time expires.
TmCod3	Temporal Code 3 0.5 seconds On, 0.5 seconds Off, 0.5 seconds On, 0.5 seconds Off, 0.5 seconds On, 1.5 seconds Off; pattern repeats. This sequence repeats for a minimum of 3 minutes and with a ± 10% tolerance.

Select the bell pattern this area uses to signal an alarm on a Fire point.

Press the [Space] bar to scroll through the selections. Press [Enter] when the correct selection appears in the display.



When an alarm occurs on two Fire points sharing the same relay, the bell pattern of the most recent fire event takes precedence.

A# Burg Time

Default: 6 minutes

Selection: One minute to 90 minutes (in one-minute increments)

Enter the number of minutes the bell rings for Burglary Alarm points. The relay activated for this time is programmed in **A# Alarm Bell** in Area Relays.

The bell output begins as soon as the burglary alarm occurs. It shuts off the bell when the programmed number of minutes expires.

When the control panel's internal clock begins a new minute, it considers the first minute expired. Program **Burg Time** for two minutes or more.



Check with your AHJ to determine the appropriate bell time for your geographical area.

A# Burg Pat

Default: Steady

Selection: Steady, Pulse, CaStd, TmCod3

Select the bell pattern this area uses to signal an alarm on a Non-fire point.

Press the [SPACE] bar to scroll through the selections. Press [ENTER] when the correct selection appears in the display.

A# Single Ring

Default:	No
Selection:	Yes or No
Yes	One bell output per arming period. After one alarm, alarms on any Non-fire points in the same area cannot restart the bell until the armed state changes. An alarm on a different point in same area restarts bell output.
No	Restart bell output with each alarm event.

Determines if an alarm from a non-fire point can restart the alarm bell time with each Alarm Event, or only start alarm output once per arming period.

This does not silence the keypad alarm bell tone, or prevent any reports. This feature does not affect Fire points. Fire points restart bell time with each new alarm.



If an alarm occurs on a 24-hour point while the area is disarmed, arming that area with a key switch does not clear the A# Single Ring flag.



Silencing the bell resets **A# Single Ring**.

A# Bell Test

Default:	No
Selection:	Yes or No
Yes	Start Bell Test.
No	Do not start Bell Test.

Provides alarm output from the relay programmed at **A# Alarm Bell** after the Closing Report is confirmed or the exit delay time expires.

Bell Test After Confirmation

In areas that send Opening and Closing Reports, the Bell Test occurs after the control panel sends the Closing Report and receives an acknowledgment from the central station receiver. For proper operation of the Bell Test after closing confirmation, the following rules apply:

- The control panel must send Opening and Closing Reports to the central station.
- Do not use restricted openings and closings or Opening and Closing Windows.

Area Armed Confirmation

In areas that do **not** report opening and closing activity, the alarm bell relay output for this area activates for 2 seconds after exit time expires.



Multiple Bell Tests occur: When more than one area is armed at the same time (such as using the ARM ALL AREAS? function), the bell rings for 2 seconds with a 2 second pause between each bell activation if all areas have the same exit delay time programmed. Otherwise, the Bell Test occurs as each area arms and it completes its exit delay time.

When areas arm simultaneously and report to the central station, the Bell Test occurs as the central station receiver confirms each area.

2.9.5 Open/Close Options

Programming determines if Opening, All Normal Closing, and Force Arm/Bypass Closing Events are sent to the remote central station. Without remote reports, all control panel and area arming (Closing Events) and disarming (Opening Events) default to local events.

Use this programming category to determine which opening and closing supervision characteristics are needed.

There are three ways to generate reports from the control panel. You can generate reports by account, by area, or a combination of both.

To suppress reports:

- Use Opening/Closing Windows to suppress reports for a specified period of time and then automatically turn them on again.
- Use the Restricted O/C options. A Closing Report is sent if the user is force arming, sending duress, or bypass arming. An Opening Report is sent if the user is disarming during an alarm condition or unbypasses points when disarming. If the system is normal, no Opening or Closing Report is sent.



For the scheduled suppression of Opening and Closing Reports, refer to *Section 5.1.1 Opening and Closing* to define Opening and Closing Windows.

Account Opening and Closing Reports

Opening and Closing Reports are sent by account when the last area in a group of areas with the same account number(s) is armed.

Area Opening and Closing Reports

Closing Reports are sent for each area as it is armed. The account number is also sent for each area.

Customizing Account Opening and Closing Reports

You can eliminate area Opening and Closing Reports from selected areas in the account by programming **A# Area O/C** as **No** for those areas.

Combination Account and Area Opening and Closing Reports

To send both account openings and closings, and individual area openings and closings for all areas in the account, you must:

- Program **A# Acct O/C** as **Yes** for all areas in the account.
- Program **A# Area O/C** as **Yes** for all areas in the account.

Closing Reports: When areas in the account are independently armed, each area generates an Area Closing Report. When the last area is armed, it also generates an Account Closing Report.

Opening Reports: When the first area in the account is disarmed, it generates an Account Opening Report along with an Area Opening Report. When the remaining areas in the account are disarmed, each area generates an Area Opening Report.

Area Only Opening Closing Supervision Features

Use these features to supervise opening and closing activity by area. Auto Close, Fail To Open, and Fail To Close all work independently of the **A# Acct O/C** feature. To use these features, program O/C Windows.

Area

Default: 1
Selection: 1 to 8

Enter the area number you are programming.

A# Acct O/C

Default: No
Selection: Yes or No

Yes	<p>Send Opening and Closing Reports by account.</p> <p>Use this selection if the control panel sends reports to an automation system that cannot interpret multiple Area Opening and Closing Reports, or if Modem Format is programmed as No in the Phone category (BFSK format is used and Opening and Closing Reports are enabled).</p> <p>An Account Opening Report is generated when the first area in an account is opened (disarmed). After the Account Opening Report is sent, disarming other areas in the account does not generate another Account Opening Report. An Account Closing Report is generated only when the last area in an account is closed (armed). Opening and Closing Reports for accounts do not contain any area information.</p> <p>Opening and Closing Windows affect Account Opening and Closing Reports: If an account opening or closing is generated while an Opening or Closing Window for this area is in effect, and Disable O/C in Window is programmed Yes, the report is not sent. Use the same opening and closing window times for all areas sharing the same account number.</p>
No	<p>Do not send Opening and Closing Reports by account.</p>

Determines if this area generates Account Opening and Closing Reports. Program this item the same for all areas in the account.

A# Area O/C

Default: Yes	
Selection: Yes or No	
Yes	Include the Area # and generate Opening and Closing Reports for this area when it is armed.
No	Do not include the Area # or generate Opening and Closing Reports for this area.

Determines if the area number and the account number are reported at arming and disarming. As long as **Account O/C** is **No**, the account number sends a report when arming this area individually. If **Account O/C** is **Yes**, all areas with the same account number must also be armed.

An Area Opening Report is generated when each area is opened (disarmed). An Area Closing Report is generated when each individual area is closed (armed).

	Do not program this item as Yes if the control panel reports to an automation system that cannot interpret multiple Area Opening and Closing Reports.
---	--

A# Disable O/C in Window

Default: Yes	
Selection: Yes or No	
Yes	Do not send Opening and Closing Reports to the central station if they occur inside an active window. If an Opening or Closing Report occurs outside a window, send it with an early or late modifier. Refer to <i>Section 5.1.1 Opening and Closing</i> on page 99. The active window must be a Closing Window for Closing Reports. It must be an Opening Window for Opening Reports.
No	Send Opening and Closing Reports to the central station even when they occur inside a programmed window. If an opening or closing occurs outside of the appropriate window, it reports but does not have an early or late modifier. If you want to monitor all opening and closing activity and use features provided by Opening and Closing Windows, program this item as No , and program the appropriate O/C Windows.

Determines if opening and closing activity is reported when it occurs inside an Opening or Closing Window, as programmed in O/C Windows.

Reports are always logged and printed on a local printer, if installed.

A# Auto Close

Default: No	
Selection: Yes or No	
Yes	The area automatically master arms at the end of the Close Window. When the area is armed automatically, a Closing Report is sent if the Area or Account Reports are programmed to do so.
No	Do not automatically arm the area at the end of the Close Window.

With this program item, the control panel can automatically master arm the area at the end of the Closing Window regardless of the previous armed state.

	When an area master arms automatically at the end of a Close window, the system disregards the settings in A# Force Arm Max and P## Bypassable for any faulted points. The faulted points arm when they return to normal state.
---	---

A# Fail to Open

Default: No	
Selection: Yes or No	
Yes	Fail to Open Report is sent for this area if the area was not disarmed when the Opening Window stop time occurred.
No	Fail to Open Report is not sent for this area.

Use to determine if a Fail to Open Report is sent for this area. This can determine if a user failed to disarm the area before the Opening Window expiring. Normal Opening and Closing Reports do not need to be programmed to use this feature.

A# Fail to Close

Default: No	
Selection: Yes or No	
Yes	Fail to Close Report is sent for this area if the area was not armed when the Closing Window stop time occurred. Note: Program an exit delay time in <i>Exit Dly Time</i> .
No	Fail to Close Report is not sent for this area. <ul style="list-style-type: none"> • If <i>Auto Close</i> is programmed Yes, a Fail to Close Report is sent because it occurs when the Closing Window stop time occurred. • If <i>Disable O/C in Window</i> is Yes, the Fail to Close Report is followed by Closing Late or F(orce) Close Late.

Determines if a Fail to Close Report is sent for this area. Use to determine if a user failed to arm the area before the Closing Window expires. Normal Opening and Closing Reports do not need to be programmed to use this feature.

A# Restrictd O/C

Default: No	
Selection: Yes or No	
Yes	Restrict Opening and Closing Reports for this area. <i>A# Area O/C</i> must be programmed Yes to generate Restricted Opening and Closing Reports. Note: If a passcode is not required for arming or disarming and this item is Yes , the area sends only Restricted Opening and Closing Reports. In this case, Restricted Reports are sent without User ID. Opening/Closing Window does not affect this report. Windows do not prevent sending Restricted Opening and Closing Reports from being sent. Early or late designations are not added to Opening or Closing Reports when they are sent according to the rules for Restricted Opening or Closing Reports.
No	Do not Restrict Opening and Closing Reports for this area. Regardless of programming in Authority Levels <i>L## Restricted O/C</i> , reports are not restricted in this area when this item is programmed as No . Note: Was Force Armed and Forced Close Events can still be sent to the central station if enabled in <i>Routing</i> when force arming the system.

This item determines if this area can restrict Opening and Closing Report activity.

A Restricted Opening Report refers to the control panel sending an Area Opening Report only when the area is disarmed after a non-fire alarm.

A Restricted Closing Report refers to the control panel sending an Area Closing Report only when the area was master armed with Controlled points that were faulted during the arming sequence. The sequence of reports generated by a restricted closing is: Was Force Armed, Forced Point, Forced Close, and Closing Report.

A# Perimeter O/C

Default: No

Selection: Yes or No

Yes	This area can send Perimeter Opening and Closing Reports.
No	This area cannot send Perimeter Opening and Closing Reports.

Determines if this area can send Perimeter Instant and Perimeter Delay Closing Reports and normal Opening Reports to the central station. Opening and Closing Windows do not suppress this event.

 Needs modem format reporting. Some central station automation systems cannot process these reports.

A# Latest Close Time

Default: 00:00

Selection: 00:00 to 24:00

Use to set a Latest Close Time boundary value for this area. If the Latest Close Time value is non-zero, the time of day specified with the Extend Close feature cannot be greater than or equal to this value. A zero value for **A# Latest Close Time** disables the feature for the area.

Example: If A# Latest Close Time is set for 17:30, the user can extend the close time to as late as 17:29.

This prompt is used only when an O/C Window is assigned to an area. Make entries in 30-minute increments using a 24-hour format. Use times that begin on the hour or the half-hour only. For example, enter 2:30 PM as 14:30. Enter 1:00 AM as 01:00. To set the Latest Close Time for midnight, use a value of 24:00. The latest close time allowed by the Extend Close feature is 24:58, because of internal limitations in the control panel.

 The default entry of 00:00 **disables** the Latest Close Time feature for this area.

The control panel sets all windows for the next day when the control panel clock turns to midnight. The control panel must cross the midnight boundary before any changes in that default setting occur. To extend across midnight, **you must use two windows:**

- To suppress reports before midnight, use one window (for example, 20:00 start to 23:59 stop).

- To suppress reports immediately after midnight, use another window (for example, 00:01 start to 02:00 stop).

2.9.6 Arming Features

A# Two Man Rule

Default: No

Selection: Yes or No

Yes	Two valid unique passcodes are required to disarm the area.
No	A single passcode with a valid authority level can disarm the area.

 The D720 Keypad does not support the Two-Man Rule feature.

Use this parameter when disarming an area that is Master Armed. After recognizing the first valid passcode, the system requests a second passcode to disarm the area. If the entry delay expires before the entry of a second valid **unique** passcode, an alarm condition occurs. This function works only when you use Passcode Disarm.

 If the area is already in an alarm condition, the first valid passcode entered after the alarm occurs silences the bell but **does not disarm** the area. Enter Code 2 appears on the display. A second valid **unique** passcode is necessary to disarm the area.

Parameter Setup Requirement:

Two Man Rule can be completed only by entering two valid unique passcodes with **L## Passcode Disarm** authority.

 To avoid unintended results for the end user of the system:

- Set **CC# Scope** to **Area Wide** for keypads assigned to areas with the Two Man Rule feature.
- Avoid setting the **A# Two Man Rule** to **Yes** in an area where **A# Early Ambush** is set to **Yes**.

 Use this feature in banks or other facilities that might require a higher level of security to gain access to a vault or other protected area.

D1255 Keypad

After the first valid passcode is entered, the D1255 replaces the scrolling `DISARM NOW` and the Point Text display with the `SECOND CODE : .display`

When the user presses the first digit of the second code, the display changes to `SECOND CODE : *`.

`SECOND CODE :` appears for ten seconds. If no digits are pressed, the display returns to normal and the area does not disarm. If a second code is entered, the area disarms and an Opening report is sent with the User ID of the first user. If the second code entered is the same as the first code, is invalid, or does not have **L## Disarm** authority, the keypad shows `NO AUTHORITY` and returns to idle text or entry delay.

D1260 Keypad

In the D1260, after the first valid passcode is entered, the following message appears for three seconds.

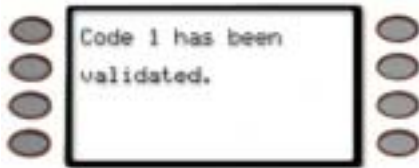

Then the next message appears requesting a second code.

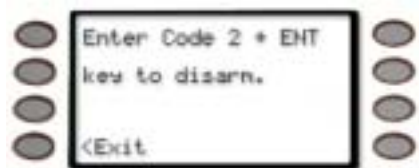

When the first digit of the second code is pressed, the following message appears. As each digit is pressed, an additional asterisk appears.

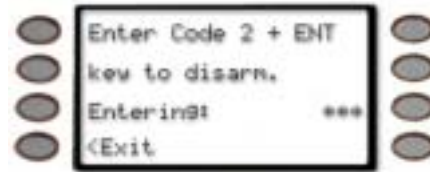

A# Early Ambush

Default: No	
Selection: Yes or No	
Yes	Two valid passcodes are required to disarm the area within the time period specified in Early Ambush Timer. The second valid disarm passcode must be entered within a time limit. Refer to Early Ambush Timer on page 132. If the second passcode is not entered within the time limit, the system generates a Duress Event based upon the primary user.
No	A single pass code with a valid authority level can disarm the area.

Use this parameter when disarming an area that is in the Master Armed state. After the first valid pass code is entered, the area is disarmed and the keypad displays the disarmed idle text normally. This function operates only when you use Passcode Disarm.

If the second valid disarm pass code is entered, the D1255 Keypad shows `CODE 2 VALIDATE` and sounds the Watch Mode tone. Only the Watch Mode tone appears on the D720 Keypad.

The D1260 Keypad sounds the Watch Mode tone and the following text appears.

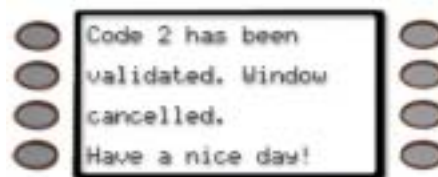

Parameter Setup Requirement:

The Early Ambush timer can be started and stopped only by pass codes with the L## Passcode Disarm authority.



To avoid unintended results for the end user of the system:

- When a keypad is assigned to an area that has the Early Ambush feature enabled, set the **CC# Scope** value to Area Wide.
- If an area has **A# Two Man Rule** set to **Yes**, do not set **A# Early Ambush** to **Yes**.

During an alarm, after the first pass code is entered, the Early Ambush timer still begins. A Cancel Report might be generated, depending upon the bell time, and the keypad displays **Alarm Silenced** normally. If the second valid disarm pass code is entered, the keypads indicate that the second pass code is valid. Refer to the **Secondary Ambush Code** prompt on page 132 for information about the unique behavior of the two pass codes.

Cmd Center

Default: 1

Selection: 1 to 8

SDI CC#	Address Number	DIP Switch Setting					
		1	2	3	4	5	6
1	1	ON	ON	ON	ON	--	ON
2	2	OFF	ON	ON	ON	--	ON
3	3	ON	OFF	ON	ON	--	ON
4	4	OFF	OFF	ON	ON	--	ON
5	5	ON	ON	OFF	ON	--	ON
6	6	OFF	ON	OFF	ON	--	ON
7	7	ON	OFF	OFF	ON	--	ON
8	8	OFF	OFF	OFF	ON	--	ON

Enter the keypad (CC) number for the SDI address you are programming. This number corresponds to the DIP switch address settings shown.

2.10 Keypad (Command Center)

This programming module contains three programming categories: Cmd Cntr Assignment, Area Text, and Custom Function.

2.10.1 Keypad (Command Center) Assignment

This programming category assigns a keypad to an area and determines if the keypad is supervised. The keypads are connected to the control panel using a two-wire serial data interface (SDI) bus.

This bus can support up to eight supervised keypads, each with its own unique keypad address (CC) and corresponding DIP switch address settings. If the keypads are not supervised, you can install multiple keypads with the same DIP switch address setting for up to 32 unsupervised keypads.

CC# Supervised

Default: Refer to the program record sheet	
Selection: Yes or No	
Yes	Only one keypad can be installed for this CC SDI address.
No	More than one keypad can be installed using this CC SDI address with the same address DIP switch setting.

Supervise this SDI address and generate Trouble SDI Reports and local trouble annunciation if a problem occurs with this keypad or the SDI bus.

 Keypads that share the same address setting display the same text and emit the same tones, regardless of which keypad's keys are pressed.

Trouble SDI # Reports are always reported as Area 1, Account 1 Events regardless of the area the SDI device is assigned.

 When this prompt is **Yes**, you cannot have duplicate DIP switch settings.

 When a D1260 Alpha V Keypad is assigned to a keypad address, you must program **CC# Supervised** as **Yes**.

CC# Area Assign

Default:	1
Selection:	1 to 8

Blank is not a valid entry.

Enter the area number where you are installing this keypad or keypads with this address and the same DIP switch settings.

CC# Scope

Default: Refer to the program record sheet	
Selection: Panel Wide, Custom, No Keypad, Area, and Account	
Panel Wide	A panel-wide keypad can view information and perform Arming and Disarming functions for all areas in the control panel. A panel-wide keypad can cross account boundaries. This is normally used with a master area.
Account	An Account keypad can view information, and perform Arming and Disarming functions for all areas with the same A# Acct Number , in Area Parameters. This is normally used for an associate area.
Area	An area keypad is restricted to viewing information and Arming or Disarming functions for the area to which it is assigned.
Custom	A custom keypad has no keypad restrictions.
No Keypad	No keypad installed at this address. CALL FOR SERVICE display shows, indicating the control panel is not polling this address.

This program item is used to define the areas affected when an arming command is executed on this keypad, the areas this keypad can view, and the areas to which this keypad can move.

Press the [SPACE] bar to scroll through the selections. Press [ENTER] when the correct selection appears in the display.

 In applications where keypads include more than one area, active alarms in remote areas must be acknowledged before arming or disarming the local area.

 The following prompts are visible **only** when you program **CC## Scope** to Custom. If you change the keypad scope selection to Custom from Panel Wide, Account, or Area, the settings from the previous **CC# Scope** selection become the default settings for the custom parameters in **CC# A1 [through A8] in Scope**. Before exiting a custom program, check each area and ensure that it is enabled and disabled correctly.

CC# A1 [through A8] in Scope

Default: Refer to the preceding important note	
Selection: Yes or No	
Yes	Include this area in the scope of this keypad.
No	Do not include this area in the scope of this keypad.

Determines whether any of the eight areas (Area 1 to Area 8) and Doors (Door 1 to Door 8) are included in the scope of this keypad for viewing status, arming or disarming, and controlling doors from the keypad.

CC# Entr Key Rly

Default: Blank	
Selection: 1 to 128, A, B, C, and Blank	
Blank	The [ENTER] key is not used to activate a relay.
1 to 128, A, B, C	Assign the relay number that activates when [ENTER] is pressed at this keypad after the user enters a valid pass code.

Enter Key Relay: Program the relay number that activates momentarily for 10 seconds when a user enters a valid pass code and presses the [ENTER] key on the keypad. Two events are generated when this function is used: RELAY ### SET with User ID, and RELAY ### RESET without User ID. The system logs this action as two events.

- Entering a valid code and pressing [ENTER] silences a ringing bell.
- Using **CC# Entr Key Rly** for a low-level access control strike on a door does not shunt a point.



When programmed to activate a relay, the [ENTER] key cannot be used for any other function.

Relays used for this function must not be shared with any other point, sensor reset, control panel, or bell functions. Sharing can cause errors in relay operation.

CC# Entr Cycl Dr

Default: No	
Selection: Yes or No	
Yes	The [ENTER] key is used to cycle the door programmed for CC Assign Door.
No	The [ENTER] key is not used to cycle the door.

Enter Key Cycle Door: Program this prompt as **Yes** to start the door cycle sequence for the door number programmed in **CC# Assign Door** when a user enters a valid pass code and presses [ENTER]. This includes shunting the point assigned to the door. ACCESS GRANTED prints on the local printer and at the central station receiver, if programmed.





- The service pass code cannot be used for the **CC# Entr Cycl Dr** application.
- When programmed to activate a relay, the [ENTER] key cannot be used for any other function.
- Relays used for this function must not be shared with any other point, sensor reset, control panel, or bell functions. Sharing can cause errors in relay operation.
- The door does not cycle if **Entr Key Rly** is programmed.
- 9210 NOT READY appears at this keypad when you press [ENTER] if the D9210B is not programmed with a **D# Entry Area** (in the RADAXS handler) or if CC Assign Door does not have a door number assigned.

CC# Assign Door

Default: Blank	
Selection: 1 to 8, Blank	
Blank	No door controller is assigned for adding tokens or the CLOSE DOOR # appears on the keypad.
1 to 8	Assign the door controller that enters the Add User Mode when initiated. If the assigned door remains open and this keypad has the CC# Close Door Warning Tone set to Yes , the CLOSE DOOR # message appears on this keypad.

Program the door number used by this keypad to add tokens or cards and to show CC Close Door.

- 
 - If a door is not programmed for this prompt and a door is not assigned to the area using the **D# Entry Area** in the RADAXS handler, IMPORTANT! 9210 NOT READY appears at this keypad when you attempt to add a user. The message indicates that the control panel cannot start the Add User Mode until a door is assigned to this keypad.
 - Assigning a door to a keypad is not necessary for the user to control the door(s) using the Door Control function. Any door that is active can be controlled by a user who has the appropriate door control authority. The door control functions are available to a valid user at any keypad with access to the area where the door is assigned.

 During the Add User Mode, tokens or cards, door control requests, and RTE/REX do not function. Put the Door Mode into an **unlocked** state before adding users if there is heavy activity for this door.

CC# Trouble Tone

Default: Yes	
Selection: Yes or No	
Yes	Panel-wide trouble tones sound and visual displays show at this keypad.
No	Panel-wide troubles do not sound. Visual displays still show.

Determines whether this keypad, or any keypad with the same address setting, emits the panel-wide trouble tones (power, phone, SDI bus, and Zonex bus).

 Panel-wide trouble tones do not include Point Troubles, Buzz on Fault, or Close Door Now.

 Assign two CCs to the same area so one keypad emits the tone and another does not.

CC# Entry Tone

Default: Yes	
Selection: Yes or No	
Yes	This keypad sounds entry tones.
No	This keypad does not sound entry tones.

Determines whether this keypad, or any keypad with the same address setting, emits the Disarm Now entry delay tone. Any Delay point within the area scope of this keypad starts the entry sequence.

 This prompt allows you to manage the tone by keypad. Entry Tone can also be turned off when programming your **P## Entry Tone** off in **Point Index**.

 Assign two CCs to the same area so one keypad emits the tone and another does not.

CC# Exit Tone

Default:	Yes
Selection:	Yes or No
Yes	This keypad sounds entry tones.
No	This keypad does not sound entry tones.

Determines whether keypads at this address setting emit the `Exit Now ###` exit delay tone during the delay arming of an area(s). Any keypad with a scope to arm this area can initiate the exit tone sequence.

This prompt allows you to manage the tone by keypad. Exit Tone can also be turned off when programming **A# Exit Tone** in Area Parameters.



Assign two CCs to the same area so one keypad emits the tone and another does not.

CC# Arm Now Warn

Default:	No
Selection:	Yes or No
Yes	This keypad activates a tone and displays <code>PLEASE CLOSE NOW</code> .
No	This keypad does not activate the tone or display <code>PLEASE CLOSE NOW</code> .

Determines whether this keypad sounds a tone and displays the `PLEASE CLOSE NOW` warning on the keypad when a Closing Window activates, indicating the area automatically arms soon.

CC# Close Door

Default:	No
Selection:	Yes or No
Yes	This keypad sounds a tone and displays <code>CLOSE DOOR #</code> .
No	This keypad does not sound the tone or activate the display.

Determines whether this keypad sounds an audible tone and displays the `CLOSE DOOR #` warning on the keypad. This occurs when the door is physically held open past the shunt time and the extend time has a value greater than zero for the door assigned to this area in **CC# Assign Door**. Refer to the *D9210B Program Entry Guide* (P/N: 32207).

CC# EnhancCmdCtr

Default:	No
Selection:	Yes or No
Yes	This keypad is a D1260 Alpha V Keypad.
No	This keypad is not a D1260 Alpha V Keypad.

When a D1260 Alpha V Keypad is installed at this keypad address, this item must be set to **Yes**.



Reboot the system to enable an Alpha V keypad.

To reboot the system, close and open the reset switch, labeled "S1 RESET," located in the upper right corner of the control panel.

CC# Passcode Follows Scope

Default: Yes	
Selection: Yes or No	
Yes	<p>Master Arming allows a user to change the armed state of the areas within the scope of this keypad. If the areas in the scope are already at the intended armed state, they remain in that state.</p> <ul style="list-style-type: none"> If the area to which this keypad is assigned is armed, entering a valid pass code disarms this area and all other areas assigned to the scope of this keypad. If the area to which this keypad is assigned is disarmed, entering a valid pass code arms this area and all other areas assigned to the scope of this keypad.
No	Restricts the scope of the keypad to the Area programmed in CC# Area Assign for the purpose of executing L## Passcode Arm and L## Passcode Disarm only.

Use this program to determine if this keypad follows **CC# Scope** or if it only arms or disarms the area to which it is assigned. The user must have authority enabled in **L## Passcode Arm** and **L## Passcode Disarm**. This feature does not affect the Function List arming and disarming commands.

	<p>Tokens and cards disarm according to this prompt. If this prompt is No, tokens disarm only the Area to which the CC# is assigned. The user must have disarming rights for tokens and cards programmed at the Disarm Level. The user does not need disarming and arming authority for the keypad.</p>
---	---

	<p>You can use this prompt for a group of account-wide keypads that only arm the area to which they are assigned, even if the user has a pass code with arming authority rights in all areas.</p>
---	---

CC# Menu Key Lock

Default: No	
Selection: Yes or No	
Yes	<p>If set to Yes, the user is prompted to enter a pass code after pressing the Menu key on the keypad. The items programmed in the Menu List for this specific keypad are filtered by the user's authority level. Only those items in the menu list for which the user has authority appear.</p>
No	<p>If set to No, when the user presses the Menu key, all items that are programmed in the Menu List for the Command Center Address (Keypad Address) appear, regardless of the user's authority level.</p>

Determines if the Menu Key, when pressed, requires a pass code to access the functions.

	<p>If this parameter is set to Yes, users must enter a pass code after pressing the Menu key. When the pass code is validated, only those functions for which the user has authority appear in the list. If a function in the Menu List is pass-code protected (refer to Keypad Functions in <i>Section 2.11.2 User Interface</i> on page) the user does not need to enter the pass code again.</p>
---	--

2.10.2 Area Text

Use this programming category to create custom Idle Text displays for the keypads.

	<p>Each display can be programmed with up to sixteen alphanumeric characters, including: A to Z, 0 to 9, ?, &, @, -, *, +, \$, #, _, /.</p> <p>Characters not listed are invalid and cannot be used for text.</p>
---	---

Area**Default:** 1**Selection:** 1 to 8

Enter the area number you are programming.

Area# Is On**Default:** Refer to the program record sheet**Selection:**

Enter the text for this area that appears when the area is master armed or master instant armed and other areas sharing the same account number are not yet master armed. This display does not appear when the area is perimeter armed.

Area# Not Ready**Default:** Refer to the program record sheet**Selection:** Sixteen alphanumeric characters

Enter the text for this area that displays when the area is disarmed but points are faulted.

Area# Is Off**Default:** Refer to the program record sheet**Selection:** Sixteen alphanumeric characters

Enter the text for this area that displays when the area is disarmed and no points are faulted.

Area# Acct Is On**Default:** Refer to the program record sheet**Selection:** Sixteen alphanumeric characters

Enter the text that appears when all areas sharing the same account number are master armed. The ACCT IS ON text appears at all keypads assigned to these areas, if more than one area has the same account number. The ACCT IS ON text also appears if only one area in the system is used. Refer to the prompts **CC# Area Assign** and **Area # Acct Is On** in *Section 2.10.1 Keypad (Command Center) Assignment* on page 45. When all areas in the account are master armed, the Area # Is On text is replaced by the ACCT IS ON text if the area is armed before all other areas with the same account number.

Blank Entry

A blank entry disables the ACCT IS ON display for this area. An account wide area shows the AREA # IS ON text instead of the ACCT IS ON text.

Unique ACCT IS ON Text

Each area can have unique ACCT IS ON text, or you can program the same text in each area of the account so when all the areas in the account are armed, they all show the same text.

D1260 Alpha V Keypad

Although it is not programmed in this area, the D1260 Alpha V Keypad can display up to sixteen characters for an Area Name on line 1 of its display. The Area Text (**Area # Is Off**, **Area # Not Ready**, **Area # Is On**, and **Acct # Is On**) programmed in this module appears on line 2 of the D1260 Alpha V Keypad. When programming custom text, it should be logical to users viewing it on the D1260. For example, the Area Name Text can be programmed to display Front Office and the **Area # Is Off** text (programmed in this section) could be programmed to display Ready To Arm. The D1260 would then show on line 1 Front Office and on line 2, Ready To Arm.

2.10.3 Custom Function

Use custom functions to simplify complex keystroke sequences entered at the keypad. These items are similar to speed dialing on a telephone. When the custom function appears on the keypad, a user can execute a request by pressing [ENTER]. You can have up to sixteen custom functions and restrict their use by area and authority level.

Each **Custom Function ###** item has sixteen characters of programmable text (**CF### Text**). When the Custom Function is assigned to the menu **M## Function** (refer to *Section 2.12 Function List* on page 70) the user can press [PREV] or [NEXT] to scroll to **CF### Text**. The user accesses the menu by pressing [MENU] on the keypad.

The user needs the appropriate authority level enabled for the **L## C Function 128 to 143** in *Section 2.11 User Interface* on page 54, to use the custom function.

Consider the scope of the keypad used to access the Custom Function. Each Custom Function is enabled in the function menu by **M## CC Address 1 [through 8]** (refer to **M## CC Address 1 [through 8]** on page 71). If the Custom Function is not assigned to a specific keypad address, it does not appear in the menu.

Custom Function

Default: 128
Selection: 128 to 143

Enter the Custom Function number you want to program. You can program up to sixteen Custom Functions, which are numbered 128 to 143.

CF### Text

Default: Refer to the program record sheet
Selection: Sixteen alphanumeric characters. See *Section 2.10.2 Area Text* on page 50 for valid character entries.

Determines the menu text displayed at the keypad for the custom function item. Use this text to represent the functions performed by this menu item.

CF### Key Strokes

Table 23: CF### Key Strokes

Default:	Refer to the program record sheet		
Selection:	Up to 32 characters: 0 to 9, A, B, C, D, E		
Selection	D1255 Key	D1255 Faceplate Label	D1260 Key
0 to 9	0 to 9		0 to 9
A	[COMMAND]		[COMMAND*]
B	[PREV] (previous)		NA
C	[ESC] (escape)	MENU	NA
D	[NEXT]		NA
E	[ENT] {enter}	YES	[#ENTER]
C1	NA		{softkey 1}
C2	NA		{softkey 2}
C3	NA		{softkey 3}
C4	NA		{softkey 4}
C5	NA		{softkey 5}
C6	NA		{softkey 6}
C7	NA		{softkey 7}
C8	NA		{softkey 8}

The keystrokes simulate any sequence of keystrokes the user can perform at a keypad. You can program up to 32 keystrokes for each Custom Function.

DS5200 Data Entry

Use the [↓] key on the D5200 to move the cursor to the first data entry line. To enter more than sixteen keystrokes, you must fill the first line of the data entry line before you move to the second line. If you make entries on the second line, and the first line has less than sixteen characters, the second line clears when you press [ENTER].



The scope of the keypad where you access the Function List can affect the way the Custom Function operates.

Figure 3: Softkey Locations on the D1260 Keypad

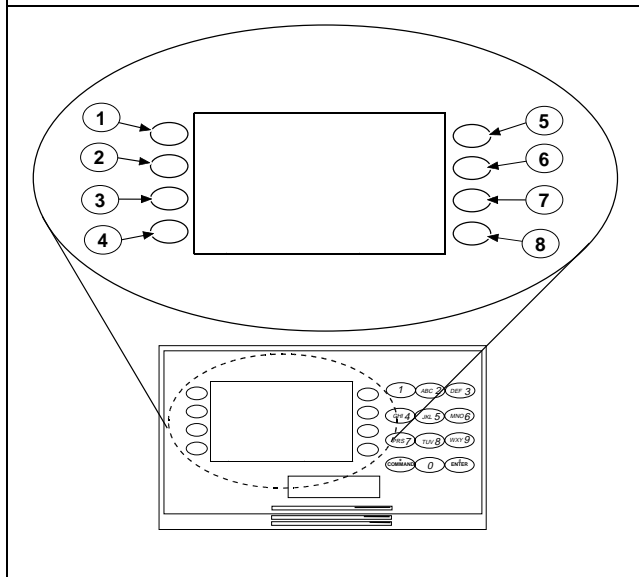

- 1 - Softkey 1 (C1)
- 2 - Softkey 2 (C2)
- 3 - Softkey 3 (C3)
- 4 - Softkey 4 (C4)
- 5 - Softkey 5 (C5)
- 6 - Softkey 6 (C6)
- 7 - Softkey 7 (C7)
- 8 - Softkey 8 (C8)

Programming Custom Function Keystrokes

- Find the command you want to execute in the *User Interface* section of the program record sheet. Single digit commands must be programmed with 9 as the second digit.

Table 24: CF### Custom Function Keystrokes

Command	Keystroke
1 (Master arm area)	A19
2 (Perimeter instant arm)	A29
3 (Perimeter delay arm)	A39
6 (Watch Mode)	A69
7 (Special alert)	A79
8 (Perimeter partial arm)	A89
9 (Special alert)	A99
0 (Bypass a point)	A09

128 to 143 Enable Custom Function 128 through 143, (Menu Function only): This function determines if a pass code is needed to access a Custom Function from the menu list. ENTER PASSCODE (or Enter Passcode + Enter Key on the D1260) appears when this function is pass-code protected.



If a command within the Custom Function is pass-code protected, ENTER PASSCODE appears at the keypad. The user must enter a valid pass code must be entered before proceeding with the rest of the Custom Function. If a pass code is not entered within 10 seconds, the Custom Function times out and the display returns to idle text.



Skeds cannot execute Custom Functions that are pass-code protected. The D720 LED keypad does not support Custom Functions that are pass-code protected.

Some functions cannot be entered directly because they are nested inside a higher-level function. To automatically execute these functions, you must add the appropriate keystrokes.

- For example: The Change Display (COMMAND 49) function has three sub-functions: Bright Display, Dim Display, and Date/Time Display.
 - To turn up the display, enter:
[A][4][9][E]
 - To dim the display, enter:
[A][4][9][D][E]
 - To display time and date, enter:
[A][4][9][B][E]
- Custom Functions can perform several tasks at one time. For example:
 - To toggle relays 7, 8, and 9 in one Custom Function enter:
[A] [5] [4] [7] [E] [E] [8] [E] [E] [9] [E] [E] [C]
 - To add a temporary pass code, enter:
[A] [5] [6] [3] [0] [E] [E] [9] [8] [7] [E] [E] [D] [E] [1] [E] [1] [E] [1] [E] [1] [E] [1] [E] [1] [E] [1] [E] [1] [E] [1] [E] [1] [E] [C]
This adds user 30, pass code 987 with authority level 1 in all areas.
 - To delete the pass code, enter:
[A] [5] [3] [3] [0] [E] [E] [E] [C]

To program multiple-area Arming or Disarming functions, use keystroke sequences including COMMAND 50 (Move to Area) and COMMAND 1.



Custom function cannot be used to change time (such as Daylight Saving Time). Use **Skeds S## Function Codes 13 and 14** to adjust for Daylight Saving Time (refer to **S## Custom Function** prompt in *Section 5.2 Skeds* on page 108).

Example 1

Execute the third function in a keypad menu function list:

```
D1255  CDDE
D1260  C8C7C5
```



The custom functions in Example 1 **are not** compatible between keypad types.

Example 2

Instant master Arm (CMD 11):

```
D1255  A11
D1260  A11
```



The custom functions in Example 2 **are** compatible between keypad types.



The D9000GV2 control panel series uses separate keystrokes to program the custom functions that accurately represent the two separate user interfaces, the D1255 and D1260 keypads.

Custom functions written for the D1255 that use the [PREV], [ESC], and [NEXT] keys do not work on the D1260.

Custom function written for the D1260 that use the softkeys (located on the sides of the keypad display) do not work when executed from the D1255 keypad.

2.11 User Interface

Define which functions can be used by each of the fourteen user authority levels. Each user can be assigned the same or different authority level by area. The user has rights in the area where the keypad is assigned, based on the authority level assigned to the user's pass code for that area.

When the pass code is entered at the keypad, the control panel checks the authority level. The control panel executes the function only in areas where the pass code has the authority to use the function.

2.11.1 Commands

Similar to command initiation used in other Bosch Security Systems products, the Commands method provides continuity in the arming commands across product lines and makes an easy transition for dealers using other Bosch Security Systems products. With commands, the end user presses [COMMAND] and then the numeral of the command to initiate. For example, [COMMAND][2] arms the perimeter of the area. Some prompts can be accessed only from a menu. These prompts are indicated by (Menu Function only). To access these functions, press [MENU], enter the function number, and use the [PREV] and [NEXT] keys to scroll through the choices.

The *D9412GV2/D7412GV2 Program Record Sheet* (P/N: F01U003635) lists the commands available with the system. Command numbers are shown in the column labeled Command. If a particular function does not have a command number, it can be accessed only through the Function List.

If you plan to use only commands to operate the system, and to arm and disarm by entering a pass code, you do not need to program Custom Function or Function List.

2.11.2 Keypad Selections

Programming choices in this section determine if keypad functions are disabled (blank), enabled (E), or restricted (P) panel-wide.

Press the [SPACE] bar to scroll through the selections. Press [ENTER] when the correct selection appears in the display.

Table 25: Keypad Programming Choices

Selection	Description
Blank	Disable the function panel-wide. The keypad shows NO AUTHORITY if you access the function using a command or the Function List.
E	Enable the function panel-wide. The function can be executed without entering a pass code.
P	Pass code required. When the pass code is entered at the keypad, the control panel checks the user's authority level. Refer to <i>Section 2.11.4 Authority Level Selections</i> on page 61.



Refer to *Section 2.11.4 Authority Level Selections* on page 61 for a detailed description of the functions on the following pages. These parameters determine only if the authority level functions are pass-code protected.

Master Arm Delay

Default:	P
Selection:	Blank, E, or P
P	Pass code: Required for all users with Master Arm Delay enabled for their authority level.
E	Enable: A user does not need a pass code to use [COMMAND][1].
Blank	Disable Master Arm Delay cannot be accessed in the function menu or started with a command even if this function is enabled for the user's authority level.

Function No.	Function Name	Alternate Keystroke
2	Master Arm Delay	[COMMAND][1]

Use this arming function to master arm disarmed areas. If enabled, the following arming choices are available to the user with this authority.

Mstr Arm Inst

Default: Blank
Selection: Blank, E, or P

Function No.	Function Name	Alternate Keystroke
3	Master Arm Instant	[COMMAND][1][1]

Use this arming function to master arm instant areas that are disarmed. If enabled, the following arming choices are available to the user with this authority. Entry and exit delays are **not** provided with this arming function. This causes a Perimeter and Interior Delay point to act as an Instant point.

Perim Instant

Default: P
Selection: Blank, E, or P

Function No.	Function Name	Alternate Keystroke
4	Perimeter Instant Arm	[COMMAND][2]

Instant arms all perimeter points with point response that starts an instant alarm (refer to *P## Pt Response* in *Section 4.2 Point Responses* on page 85) in the area where the keypad is assigned. Entry and exit delays are **not** provided with this arming function. This function causes a Perimeter Delay point to act as a Perimeter Instant point.

Perim Delay

Default: P
Selection: Blank, E, or P

Function No.	Function Name	Alternate Keystroke
5	Perimeter Delay Arm	[COMMAND][3]

Delay arms all Perimeter points in the area where the keypad is assigned. Entry and exit delays are provided with this Arming function. This function does not cause a Perimeter Instant point to act as a Delay point.

Watch Mode

Default: E
Selection: Blank, E, or P

Function No.	Function Name	Alternate Keystroke
6	Watch Mode	[COMMAND][6]

This function informs you when a perimeter point or interior point that is programmed as **P## Watch Point** is faulted while the area is disarmed. Interior points do not emit a Watch Tone if the area is perimeter armed. This function provides keypad audible or visual and optional relay activation (refer to **A # Watch Mode** in *Section 2.13.1 Area Relays* on page 72).

Perim Partial

Default: P
Selection: Blank, E, or P

Function No.	Function Name	Alternate Keystroke
7	Perimeter Partial Arm	[COMMAND][8]

Use this function to arm normal perimeter points and force-bypass faulted perimeter points, regardless of their P## Bypassable setting. When these force-bypassed perimeter points return to normal, they automatically return to service, even if P## FA Returnable is set to No.

Perimeter Partial arming has entry and exit delays.



Perim Partial ignores the **A# FA Bypass Max** entry in *Section 2.9 Area Parameters* on page 32.



Local Only Reporting: No Closing Report is sent to the central station, but a Perimeter Delay Closing Event is generated in the event log.

View Area Stat

Default: P
Selection: Blank, E, or P

Function No.	Function Name	Alternate Keystroke
8	View Area Status	(Menu function only)

Use this function to view the armed status of all areas within the scope of the keypad assigned to this area. The armed states include A# AREA # IS OFF (disarmed), A# AREA # IS ON (master delay armed), ALL ON INSTANT (master instant armed), and AREA # PERIM ON (perimeter instant armed or perimeter delay armed). All area types, master, associate, regular, and shared can be viewed using this function.

View Memory

Default: E
Selection: Blank, E, or P

Function No.	Function Name	Alternate Keystroke
9	View Event Memory	[COMMAND][4][0]

Use this function to view prior alarm, trouble, and supervisory activity occurring since the last time the system armed. Event memory is not cleared until the area re-arms.

View Pt Status

Default: E
Selection: Blank, E, or P

Function No.	Function Name	Alternate Keystroke
10	View Point Status	(Menu function only)

Use this function to view points assigned to the area where the keypad is assigned. This function shows point text and the electrical condition (normal, open, short, and missing) of each point in the area.

Walk Test

Default: E
Selection: Blank, E, or P

Function No.	Function Name	Alternate Keystroke
11	Walk Test	[COMMAND][4][4]

Use this function to test Controlled points in areas within the keypad's scope without sending reports to the central station. 24-hour points cannot be tested using this Walk Test Mode.

Fire Test

Default: P
Selection: Blank, E, or P

Function No.	Function Name	Alternate Keystroke
12	Fire Test	[COMMAND][5][8]

Use this function to test 24-hour points in areas within the scope of the keypad where the function is entered. Controlled points, **P## Type 1, 2, 3**, cannot be tested using the Fire Walk Test Mode.

Send Report

Default: P
Selection: Blank, E, or P

Function No.	Function Name	Alternate Keystroke
13	Send Report	[COMMAND][4][1] or [COMMAND][4][2]

Use this function to test the communication link between the control panel and the central station receiver(s). It can send a Test Report or a Status Report to the phone numbers programmed in Routing. The Test Report includes additional information if **Expand Test Rpt** is enabled in *Section 2.1 Phone* on page 9.

2.11.3 Access Control Functions

Door Control

Default: P
Selection: Blank, E, or P

Function No.	Function Name	Alternate Keystroke
14	Door Control	[COMMAND][4][6]

#14 Door Control [COMMAND][4][6]

This top level display must be enabled for the user to access the cycle door, unlock door, and secure door functions (refer to *Section 2.11.4 Authority Level Selections* on page 61). Use this item when programming door control in your function menu.

Access Ctl Level

Default: P
Selection: Blank, E, or P

Function No.	Function Name	Alternate Keystroke
37	Access Control Levels	(Menu function only)

Shows the current on or off state of control levels 1 through 14, pertaining to Access Control Only, (**L## Access Level** and **L## Disarm Level**). The user can toggle levels on and off and invalidate access control levels during an extended period. This change only affects the user's token or cards; it does not affect keypad Door Control functions.

Chg Display

Default: E
Selection: Blank, E, or P

Function No.	Function Name	Alternate Keystroke
15	Change Display	[COMMAND][4][9]

Use this function to select either a bright or dim display with loud or soft keypad warning tones. You can also choose the time and date display.

Chg Time/Date

Default: E
Selection: Blank, E, or P

Function No.	Function Name	Alternate Keystroke
16	Change Time and Date	[COMMAND][4][5]

Use this function to set the time and date in the control panel.

Chg Passcode

Default: P
Selection: Blank, E, or P

Function No.	Function Name	Alternate Keystroke
17	Change Passcodes	[COMMAND][5][5]

Use this function to change your pass code. This is a panel-wide function that can be executed from any keypad assigned to an area where the user has authority.



Refer to *Section 2.11.4 Authority Level Selections* on page 61 for a detailed description of the functions on the following pages. These parameters determine only if the authority level functions are pass-code protected.



Regardless of whether an E or a P is entered when a COMMAND 55 is performed, the keypad asks for the user's current pass code first.

Add User

Default: P
Selection: Blank, E, or P

Function No.	Function Name	Alternate Keystroke
18	Add User	[COMMAND][5][6]

Use this function to add or change pass codes, add or change tokens or cards and Sub-users, and add or change control panel authority levels (L##) by area.

Del User

Default: P
Selection: Blank, E, or P

Function No.	Function Name	Alternate Keystroke
19	Delete User	[COMMAND][5][3]

Use this function to delete a user's pass code and tokens or cards. It does not delete user names.



This function deletes the pass code, master user, and all sub-users associated with the user number.

Extend Close

Default: P
Selection: Blank, E, or P

Function No.	Function Name	Alternate Keystroke
20	Extend Close	[COMMAND][5][1]

Use this function to change the expected closing time for the area. The window cannot be adjusted until the Close Early Begin time passes and the Closing Window is active.

View Log

Default: E
Selection: Blank, E, or P

Function No.	Function Name	Alternate Keystroke
21	View Log	(Menu function only)

Use this function to view all of the system events, their time stamps, User IDs, or point numbers. User Name and Point Text are **not stored** in the event log, but they appear when the control panel matches them with the User ID ### and the Point ###.

Each event appears on one line in the log. Any information related to that event appears on a separate line in the log.

The log in the control panel can store 500 to 1000 events.

Print Log

Default: P
Selection: Blank, E, or P

Function No.	Function Name	Alternate Keystroke
22	Print Event Log	(Menu function only)

Use this function to print all the events stored in the control panel beginning at the start date and ending with the last event in the log.

User Cmd 7

Default: P
Selection: Blank, E, or P

Function No.	Function Name	Alternate Keystroke
23	User COMMAND 7	[COMMAND][7]

Use this function to activate an alarm programmed in COMMAND 7 in the RADXPNTS Handler.

User Cmd 9

Default: P
Selection: Blank, E, or P

Function No.	Function Name	Alternate Keystroke
24	User COMMAND 9	[COMMAND][9]

Use this function to activate an alarm programmed in COMMAND 9 in the RADXPNTS Handler.

Bypass a Pt

Default: P
Selection: Blank, E, or P

Function No.	Function Name	Alternate Keystroke
25	Bypass a Point	[COMMAND][0]

Use this function to bypass individual points that have **P## Bypassable** enabled. Points within the scope of the keypad can be bypassed where the function is entered (refer to *Section 2.10.1 Keypad (Command Center) Assignment*) on page 45.

The control panel ignores alarms and troubles, and does not display point faults when a point is bypassed.

Unbypass a Pt

Default: P
Selection: Blank, E, or P

Function No.	Function Name	Alternate Keystroke
26	Unbypass a Point	[COMMAND][0][0]

Use this function to unbypass individual points that are programmed either **P## FA Retrnable** or **P## Bypass Returnable**. Points within the scope of the keypad can be unbypassed where the function is entered (refer to *Section 2.10.1 Keypad (Command Center) Assignment*) on page 45. The control panel responds to alarms and troubles, and displays point faults when a point is unbypassed.

Reset Sensors

Default: E
Selection: Blank, E, or P

Function No.	Function Name	Alternate Keystroke
27	Reset Sensors	[COMMAND][4][7]

Use this function to activate the Reset Sensors function for Fire or Intrusion points programmed as **P## Resettable** in *Section 4.1 Point Index* on page 81. Points within the scope of the keypad where the function is entered reset. Refer to *Section 2.10.1 Keypad (Command Center) Assignment* on page 45.

Change Relay

Default: P
Selection: Blank, E, or P

Function No.	Function Name	Alternate Keystroke
28	Change Relays	[COMMAND][5][4]

Use this function to manually set and reset Relays 1 through 128 (1 through 64 in a D7412GV2) that are installed in the system.

Remote Program

Default: P
Selection: Blank, E, or P

Function No.	Function Name	Alternate Keystroke
29	Remote Programming	[COMMAND][4][3]

Use this function to start remote programming software (RPS) sessions. When the phone is ringing at the control panel, starting this function causes the control panel to seize the line.

Move to Area

Default: P
Selection: Blank, E, or P

Function No.	Function Name	Alternate Keystroke
30	Move to Area	[COMMAND][5][0]

Use this function to switch the keypad's assignment temporarily to a different area. This command can be used to perform any function that can be performed by a keypad assigned to the area in programming.

Users are limited to performing functions enabled by the authority level they have in the area to which the keypad is moved. After 15 seconds of no activity at the keypad, the keypad reverts back to the originally programmed area.

Display Rev

Default: E
Selection: Blank, E, or P

Function No.	Function Name	Alternate Keystroke
32	Display Software Revision	[COMMAND][5][9]

Use this function to show the control panel's software revision number in the keypad display.

Service Walk

Default: P
Selection: Blank, E, or P

Function No.	Function Name	Alternate Keystroke
33	Service Walk Test	(Menu function only)

Use this function to Walk Test all 246 points in the entire control panel regardless of the **P### Type**.



The Service Walk Test is available on the D9412GV2 using the Service Menu [9][9][ENT]. The D7412GV2 **does not** include the Service Walk Test in the Service Menu. In the D7412GV2, the Service Walk Test function must be enabled in the Function List to access the Service Walk Test.

Default Text

Default: P
Selection: Blank, E, or P

Function No.	Function Name	Alternate Keystroke
34	Default Text	[COMMAND][5][7]

Determining the armed state of an area using the programmed custom text might be difficult. Use this function to switch temporarily to the control panel default text, shown on the program record sheet.

Change Skeds

Default: P
Selection: Blank, E, or P

Function No.	Function Name	Alternate Keystroke
35	Change Skeds	[COMMAND][5][2]

Execute this panel-wide function from any keypad assigned to an area where the user has authority. Use this function to change the **S### Time** from the keypad to make adjustments to Skeds.

#36 Invisible Walk Test

Default: P
Selection: Blank, E, or P

This function allows a user with the **L## Invisible Walk Test** authority to test invisible interior or perimeter controlled points that are within the scope of the keypad, without sending reports to the central station. Invisible points must have the **P## Invisible Pt** function programmed **Yes**.

Custom Functions

C Function 128 [through 143]

Default: E
Selection: Blank, E, or P

Function No.	Function Name	Alternate Keystroke
128 through 143	Enable Custom Functions 128 through 143	(Menu function only)

When enabled, Custom Function determines if a pass code is required when accessing a custom function from the menu list. ENTER PASSCODE (or Enter Passcode + Enter Key on the D1260) appears when this function is pass-code protected. If a command within the Custom Function is pass-code protected, the keypad displays ENTER PASSCODE (or Enter Passcode + Enter Key on the D1260) and waits for the user to enter a valid pass code before proceeding with the rest of the Custom Function. If a pass code is not entered within 10 seconds, the Custom Function times out and the display returns to idle text.

2.11.4 Authority Level Selections

Use *Section 2.11.4 Authority Level Selections* on page 61 to determine which Authority Level can access keypad functions that are pass-code protected. Selecting **Enable items** in the Authority Level section is not necessary if the keypad function is disabled or enabled. Each individual function has two selections you can use for the authority level you are programming.

Press the [SPACE] bar to scroll through the selections. Press [ENTER] when the correct selection appears in the display.

Table 26: Authority Level Selections

Authority Level	Description
Blank	Disabled: This function is not authorized for the user who is assigned this authority level.
E	Enabled: This function is authorized for the user who is assigned this authority level.

Authority Level

Default: 1
Selection: 1 to 14

Enter the number of the authority level you want to program. Authority Level 15 (Service Passcode) cannot be edited.



To determine the **L##** default values on pages 61 through 70, refer to the *User Interface* section for the GV2MAIN Handler in the program record sheet.

L## Disarm

Default: Refer to the program record sheet
Selection: Blank or E

Function No.	Function Name
1	Disarm

Use the disarming function to disarm areas that are master armed or perimeter armed. If enabled, the following disarming choices are available to the user with this authority:

- **DISARM ALL:** Disarms all areas within the **CC# Scope** of the keypad being used by accessing the Function Menu and the authority level of the user performing the function.
- **DISARM AREA:** Disarms only the displayed area.



Many options are available for arming and disarming. Selecting an option depends on **A# Area Type** and **CC# Scope**. Read the definitions of area type in *Section 2.9 Area Parameters* on page 5 and **CC# Scope** in *Section 2.10.1 Keypad (Command Center) Assignment* on page 45.

L## Master Arm Delay

Default: Refer to the program record sheet
Selection: Blank or E

Function No.	Function Name	Alternate Keystroke
2	Master Arm Delay	[COMMAND][1]

Master arms areas based on the *CC# Scope* of the keypad using an exit delay time.

When this item is accessed through the Function List, Master Arm All allows the user to arm all areas according to the authority level of the user and within the *CC# Scope* of the keypad using an exit delay time.

Arm Area arms only the area displayed. If COMMAND 1 is used, it arms only the area where the keypad is assigned.

L## Mstr Arm Inst

Default: Refer to the program record sheet
Selection: Blank or E

Function No.	Function Name	Alternate Keystroke
3	Master Arm Instant	[COMMAND][1][1]

This authority level permission allows a user to execute the Master Arm Inst function. Refer to *Mstr Arm Inst* on page 55.

Arm Area arms only the area to which the keypad is assigned.

If COMMAND 11 is used, it arms only the area where the keypad is assigned.

 Use COMMAND 11 carefully because all Perimeter and Interior points become Instant Armed.

L## Perim Instant

Default: Refer to the program record sheet
Selection: Blank or E

Function No.	Function Name	Alternate Keystroke
4	Perimeter Instant Arm	[COMMAND][2]

Instant arm all Perimeter points, including Delayed points, only in the area where the keypad is assigned.

L## Perim Delay

Default: Refer to the program record sheet
Selection: Blank or E

Function No.	Function Name	Alternate Keystroke
5	Perimeter Delay Arm	[COMMAND][3]

Delay arm all Perimeter Delay point responses only in the area where the keypad is assigned.

L## Watch Mode

Default: Refer to the program record sheet
Selection: Blank or E

Function No.	Function Name	Alternate Keystroke
6	Watch Mode	[COMMAND][6]

Initiate the Watch Mode in the area to which this keypad is assigned.

L## Perim Partial

Default: Refer to the program record sheet
Selection: Blank or E

Function No.	Function Name	Alternate Keystroke
7	Perimeter Partial Arm	[COMMAND][8]

Partially arms only the area where the keypad is assigned.



This function ignores the *A# FA Bypass Max* entry in Area Parameters.



Local Only Reporting: No Closing Report is sent to the central station, but a Perimeter Delay Closing Event is generated in the event log.

L## View Area Stat

Default: Refer to the program record sheet
Selection: Blank or E

Function No.	Function Name	Alternate Keystroke
8	View Area Status	(Menu function only)

View the current arm or disarm status and the not ready to arm status of all areas within the scope of the keypad in this area. The user needs arming and disarming authority.

L## View Memory

Default: Refer to the program record sheet
Selection: Blank or E

Function No.	Function Name	Alternate Keystroke
9	View Event Memory	[COMMAND][4][0]

View all memory events that occurred since the last time the system was armed for all areas within the scope of the keypad in this area.

L## View Pt Status

Default: Refer to the program record sheet
Selection: Blank or E

Function No.	Function Name	Alternate Keystroke
10	View Point Status	(Menu function only)

View the current status of all points in the area to which this keypad is assigned.

L## Walk Test

Default: Refer to the program record sheet
Selection: Blank or E

Function No.	Function Name	Alternate Keystroke
11	Walk Test	[COMMAND][4][4]

Walk Test all Interior or Perimeter Controlled points in the area to which this keypad is assigned.

The following features come with the Walk Test Mode:

- Battery powered control panel only. A Battery Test runs during the whole test to ensure that the battery capacity is capable of supporting the full load of the control panel if AC fails.
 - This test includes two-second Bell Test when the Walk Test starts.
 - The test ends when all points are tested or the test times out after 20 minutes of no activity.
- Local alarm annunciation and event printing; no reports are sent to the central station receiver.
- D1255 Keypad displays a sequential count, and text after each point is activated and restored.
- The keypad displays ALL PTS TESTED and an All Points Tested Event is sent to the central station receiver (if programmed) when the last point is tested.

- If enabled in Routing, Walk Start and Walk End Reports are sent to the central station receiver at the beginning and end of the test.



To Walk Test a Door point connected to a D9210B Access Interface Module, open the door without activating the door sequence or allowing it to time out past the extended shunt time.

L## Fire Test

Default: Refer to the program record sheet
Selection: Blank or E

Function No.	Function Name	Alternate Keystroke
12	Fiire Test	[COMMAND][5][8]

Fire Walk Test all 24-hour points in the area where this keypad is assigned.

One person can perform a Fire Walk Test without assistance. The following features come with the Fire Test Mode:

- Battery powered control panel only. A Battery Test runs during the whole test to ensure that the battery capacity is capable of supporting the full load of the control panel if AC fails.
 - This test includes a 2-second Bell Test (Fire Bell relay) for each Fire point that is tested.
 - The test ends when all points are tested or the test times out after 20 minutes of no activity.
- Local alarm annunciation and event printing; no reports are sent without reporting to the central station receiver.
- Automatic smoke detectors reset for all Fire points programmed with **P## Resettable** as **Yes**.
- D1255 Keypad displays a sequential count and the text for the point after each point is activated and restored.
- If enabled in Routing, Walk Start and Walk End Reports are sent to the central station receiver at the beginning and end of the test.



A# Verify Time for Fire points that is programmed with **Yes** for **P## Alarm Verify** is ignored during the Fire Walk Test.

L## Send Report

Default: Refer to the program record sheet
Selection: Blank or E

Function No.	Function Name	Alternate Keystroke
13	Send Report	[COMMAND][4][1] or [COMMAND][4][2]

Send a Test Report from any keypad assigned to an area where the user has authority.

Access Control Functions

Use the following functions to control the doors from the keypad. Users can have authority to access the Door Control and can use all or part of the functions within.



All doors display when this function is selected. This function does not follow the scope of the keypad.

L## Door Control

Default: Refer to the program record sheet
Selection: Blank or E

Function No.	Function Name	Alternate Keystroke
14	Door Control	[COMMAND][4][6]

This item only allows programming access to the following three sub-prompts. It does not affect the user's access to Cycle Door, Unlock Door, and Secure Door.



Cycle Door, Unlock Door, and Secure Door cannot be accessed through the Function List. Door Control must be added to the Function List to access the door control functions, or COMMAND 46 can be used.

The following prompts are sub-functions of Door Control. They become visible in the D5200 Programmer when you Enable Door Control and press [ENTER] on the D5200.



Cycle Door must be enabled for all three sub-functions to operate. If Cycle Door is disabled, all three sub-functions do not operate.

L## Cycle Door

Default: Refer to the program record sheet
Selection: Blank or E

Function No.	Function Name	Alternate Keystroke
(None)	Cycle Door	(Menu function only)

Cycle Door (Menu Function only)

To cycle the doors, press number [1] through [8] on the keypad, corresponding to the door number. For example, pressing [2] and [ENTER] cycles door number 2, which is indicated by C in the display. Refer to "Cycle Door" in *Table 27* on page 65.

Cycle Door allows the user with this authority level to access the CYCLE? 12345678 function.

L## Unlock Door

Default: Refer to the program record sheet
Selection: Blank or E

Function No.	Function Name	Alternate Keystroke
(None)	Unlock Door	(Menu function only)

To unlock or relock a door, press number [1] through [8] on the keypad, corresponding to the door number (refer to "Unlock Door" in *Table 27* on page 65). For example, pressing [2] and [ENTER] unlocks door number 2. The display indicates "U" (for unlock door) with the door number.

Unlock Door allows the user with this authority level to access the UNLOCK? 12345678 function.

L## Secure Door

Default: Refer to the program record sheet
Selection: Blank or E

Function No.	Function Name	Alternate Keystroke
(None)	Secure Door	(Menu function only)

Press number [1] through [8] on the keypad, corresponding to the door number to secure or unsecure a door (refer to "Secure Door" in *Table 27* on page 65). For example, pressing [2] and [ENTER] secures door number 2, which is indicated by an X in the display.

Secure Door allows the user with this authority level to access the SECURE? 12345678 function.

Table 27: L## Secure Door-Door Mode Definitions

Door State	Definition
Lock Door	Normal Door: When a door is in the Lock Door state, one can initiate the door sequence using Skeds, CYCLE DOOR?, keypad functions, door requests, and valid token or card requests.
Secure Door	No Access Allowed: When a door is in the Secure Door state, no access is allowed through the door until it is returned to the Lock Door state. The Secure Door state includes Sked and keypad functions.
Unlock Door	Free Access: When a door is in the Unlocked Door state, the door is already shunted and the door strike does not prevent the door from opening. In this state, the user does not need to activate a door request or present a valid token or card.
Cycle Door	Momentary Access: This is a temporary Door Mode in which the door initiates the door sequence as if a valid token or card was read. This state occurs using the keypad and remote programming software (RPS). A sked cannot activate this state.

L## Access Ctl Lvl

Default: Refer to the program record sheet
Selection: Blank or E

Function No.	Function Name	Alternate Keystroke
37	Access Control Levels	(Menu function only)



Changing the Access Control Level in any area affects all users and all doors associated with that level for all areas.

General Functions**L## Chg Display**

Default: Refer to the program record sheet
Selection: Blank or E

Function No.	Function Name	Alternate Keystroke
15	Change Display	[COMMAND][4][9]

Change the display (bright display, dim display, and time display) in the area where this keypad is assigned.

L## Chg Time/Date

Default: Refer to the program record sheet
Selection: Blank or E

Function No.	Function Name	Alternate Keystroke
16	Change Time and Date	[COMMAND][4][5]

Change the date and time for the control panel in this area.

L## Chg Passcode

Default: Refer to the program record sheet
Selection: Blank or E

Function No.	Function Name	Alternate Keystroke
17	Change Passcodes	[COMMAND][5][5]

Change a user pass code.

L## Add User

Default: Refer to the program record sheet
Selection: Blank or E

Function No.	Function Name	Alternate Keystroke
18	Add User	[COMMAND][5][6]

Add or change users, add or change authority levels, add or change tokens or cards.



9210 NOT READY appears if a door controller is not assigned to the keypad used to add or change tokens or cards. Refer to **CC# Assign Door** in *Section 2.10.1 Keypad (Command Center) Assignment* on page 45.

L## Del User

Default: Refer to the program record sheet
Selection: Blank or E

Function No.	Function Name	Alternate Keystroke
19	Delete User	[COMMAND][5][3]

Delete users.



Although an individual user (001 through 249) can be deleted separately, use caution with this function. User pass codes, tokens or cards cannot be deleted individually within a group. (For example, User 001 has three additional sub-users that use the same authority levels for that group.) When dealing with an individual user, change that user's token or pass code so that other users in the group do not need to be added again.

L## Extend Close

Default: Refer to the program record sheet
Selection: Blank or E

Function No.	Function Name	Alternate Keystroke
20	Extend Close	[COMMAND][5][1]

Change the closing time in the area where the function is entered.

L## View Log

Default: Refer to the program record sheet
Selection: Blank or E

Function No.	Function Name	Alternate Keystroke
21	View Log	(Menu function only)

View all panel-wide events in the control panel's memory log.

L## Print Log

Default: Refer to the program record sheet
Selection: Blank or E

Function No.	Function Name	Alternate Keystroke
22	Print Event Log	(Menu function only)

Print all panel-wide events from the log to the printer in the area where the user is executing this function.



This item can also be accessed using the Service Menu ([9][9][ENT]).

L## User Cmd 7

Default: Refer to the program record sheet
Selection: Blank or E

Function No.	Function Name	Alternate Keystroke
23	User Command 7	[COMMAND][7]

This command can be used in Function Menu. Generate the alarm programmed at COMMAND 7 in the RADXPNTS Handler.

L## User Cmd 9

Default: Refer to the program record sheet
Selection: Blank or E

Function No.	Function Name	Alternate Keystroke
24	User Command 9	[COMMAND][9]

This command can be used in Function Menu. Generate the alarm programmed at COMMAND 9 in the RADXPNTS Handler.

L## Bypass a Pt

Default: Refer to the program record sheet
Selection: Blank or E

Function No.	Function Name	Alternate Keystroke
25	Bypass a Point	[COMMAND][0]

Bypass points with this authority level

L## Unbypass a Pt

Default: Refer to the program record sheet
Selection: Blank or E

Function No.	Function Name	Alternate Keystroke
26	Unbypass a Point	[COMMAND][0][0]

Unbypass points with this authority level.

L## Reset Sensors

Default: Refer to the program record sheet
Selection: Blank or E

Function No.	Function Name	Alternate Keystroke
27	Reset Sensors	[COMMAND][4][7]

Reset sensors with this authority level.

L## Change Relay

Default: Refer to the program record sheet
Selection: Blank or E

Function No.	Function Name	Alternate Keystroke
28	Change Relays	[COMMAND][5][4]

Manually activate or reset a system relay.



Do **not** use the Chg Relays? function to toggle relays reserved for special functions. Special function relays are Area and Panel Wide Relay functions as well as relays assigned to **CC# Entr Key Rly?**

L## Remote Program

Default: Refer to the program record sheet
Selection: Blank or E

Function No.	Function Name	Alternate Keystroke
29	Remote Programming	[COMMAND][4][3]

Start a remote programming software (RPS) session when the phone rings at the control panel.

L## Move to Area

Default: Refer to the program record sheet
Selection: Blank or E

Function No.	Function Name	Alternate Keystroke
30	Move to Area	[COMMAND][5][0]

Temporarily switch to a different area and perform keypad functions related to that area.

L## Display Rev

Default: Refer to the program record sheet
Selection: Blank or E

Function No.	Function Name	Alternate Keystroke
32	Display Software Revision	[COMMAND][5][9]

Display the control panel model name and software revision. For example:

9412GV2 REV ##.##

L## Service Walk

Default: Refer to the program record sheet
Selection: Blank or E

Function No.	Function Name	Alternate Keystroke
33	Service Walk Test	(Menu function only)

Start a Service Walk Test for all 24-hour Interior or Perimeter Controlled points in the control panel.

Points are not included in this test if:

- Points are in an area that is already in a Walk Test Mode.
- Points are assigned to an area that is not enabled **A# Area On**.
- Points are in an area that is Master or Perimeter armed.
- A Service Walk Test is initiated, and one person can test all the points in the control panel without assistance. The following features are provided with the Service Test Mode:
 - Display indicates exactly how many points can be tested.
 - Battery and bell tests do not occur during this Walk Test.
 - The test ends when all points are tested or the test times out after 20 minutes of inactivity.
 - Events print locally without alarm annunciation or reporting to the central station receiver.
 - D1255 Keypad displays a sequential count and the text for the point after each point is activated and restored.
 - The D1255 Keypad displays ALL PNTS TESTED.
 - If enabled in Routing, Service Start and Service End are reported at the central station receiver for the beginning and end of the test.

Point 128 and Point 248 appear as missing. This is normal. These points are used for supervising the Zonex 1 bus (Point 128) and Zonex 2 bus (Point 248). If the Zonex bus has a fault, these points indicate a short.

This function allows viewing of extra points. Extra points occur under two conditions: an extra point is wired electrically to the Zonex bus with a blank **P### Point Index**, or two Zonex devices exist for the same Zonex address.

L## Default Text**Default:** Refer to the program record sheet**Selection:** Blank or E

Function No.	Function Name	Alternate Keystroke
34	Default Text	[COMMAND][5][7]

Temporarily show the armed state of the area using control panel default text, A# AREA # IS ON, A# NOT READY, A# AREA # IS OFF, and A# ACCOUNT IS ON.

L## Change Skeds**Default:** Refer to the program record sheet**Selection:** Blank or E

Function No.	Function Name	Alternate Keystroke
35	Change Skeds	[COMMAND][5][2]

Change skeds that can be edited.



Editing of skeds can be restricted by programming **S## Time Edit?** to No.

L## Invisible Walk Test**Default:** Refer to the program record sheet**Selection:** Blank, or E

Test all points that are programmed to be invisible and that are within the scope of the keypad without sending reports to the central station. Invisible points must be programmed **P## Invisible Pt** as **Yes**. This walk test mode can test 24-hour points and controlled points.

Invisible Test? allows the user with this L## to start an invisible walk test for all 24-hour interior and posterior controlled points in the area to which this keypad is assigned. When an invisible test is started, one person can test invisible points without assistance.

The following features are provided with the Invisible Test Mode:

- The display indicates exactly how many invisible points are assigned to the area.
- Battery and bell tests do not occur during this walk test.
- The keypad shows point text when invisible points are tested.
- The test ends when all points are tested, or if the test times out after ten minutes of no activity.

- Local event printing occurs without alarm annunciation or reports sent to the central station receiver.
- The D1255 Keypad shows a sequential count and text related to the point after each point is activated and restored.
- The keypad shows ALL PTS TESTED. An All Points Tested Event is sent to the central station receiver (if programmed) when the last point is tested.
- Walk Start and Walk End Reports are sent to the central station receiver for the beginning and end of the test (if programmed in phone routing).

Custom Functions**L## C Function 128 [through 143]****Default:** Refer to the program record sheet**Selection:** Blank or E

Function No.	Function Name	Alternate Keystroke
128 through 143	Enable Custom Function 128 through 143	(Menu function only)

Execute the desired Custom Function.

Report Levels**L## Force Arm****Default:** Refer to the program record sheet**Selection:** Blank or E

A user with this authority level can Force Arm.

L## Area O/C**Default:** Refer to the program record sheet**Selection:** Blank or E

Generates Opening and Closing Reports if the area where this authority level is assigned sends Opening and Closing Reports.

L## Restricted O/C**Default:** Refer to the program record sheet**Selection:** Blank or E

Generates an Opening Report if a bell is ringing or a Closing Report when force or bypass arming. The area where this authority level is assigned must be programmed for restricted openings and closings (refer to the **A# Restrictd O/C** prompt in *Section 2.9.5 Open/Close Options* on page 39.

L## Perimeter O/C

Default: Refer to the program record sheet
Selection: Blank or E

Generates Perimeter Opening and Closing Reports if the area where this authority level is assigned sends Perimeter Opening and Closing Reports.

L## Send Duress

Default: Refer to the program record sheet
Selection: Blank or E

Generates a Duress Report if the area where this authority level is assigned sends duress. (Refer to the *A# Duress Enable* prompt in *Section 2.9.5 Open/Close Options* on page 39.)

L## Passcode Arm

Default: Refer to the program record sheet
Selection: Blank or E

Arm an area by entering a pass code and pressing [ENTER].

L## Passcode Disarm

Default: Refer to the program record sheet
Selection: Blank or E

Disarm an area by entering a pass code and pressing [ENTER].

2.11.5 Access Control Levels

L## Security Level

Default: Refer to the program record sheet
Selection: M, P, D, or Blank

M	Users have access rights for this area when the area is in any armed state.
P	Users have access rights for this area when the area is Perimeter Armed or Disarmed but not while the area is Master Armed.
D	Users have access rights for this area only while it is disarmed.
Blank	Users do not have access rights to this area.

Security Level [TOKEN FUNCTION]

When the user presents a token or card at the reader, access is granted only when the user has the authority to enter the area under certain armed conditions.

L## Disarm Level

Default: Refer to the program record sheet
Selection: I, D, or Blank

I	Users change the Master Armed state and Perimeter Armed state to Perimeter Instant. The armed state does not change in other areas, and the armed state does not change if the area is already in the perimeter instant or disarmed state. User needs access level for Master Armed (M) state.
D	Users change the local area's Master Armed state and Perimeter Armed state to the Disarm state. User needs access level for Master Armed (M) or Perimeter Armed (P) state. All areas within the scope of the keypad assigned to the <i>D# CC# Scope</i> in the access handler, and areas to which the user has disarm rights, disarm as programmed.
Blank	Users do not have disarm rights in this area.



Burglar bells are silenced in the local area when a user disarms with a token or card or presents the token or card during an alarm. The user must use a pass code to silence a Fire Bell. Cancel Reports are sent after a valid pass code or token or card silences the bell.



Opening and Closing Reports are sent to the central station receiver if programmed. For more information on programming this prompt for a shared area, refer to *Access Control Readers Assigned to the Shared Area* in *Section 2.9.3 Shared-Area Characteristics* on page 37.

L## Function Level

Default:	Refer to the program record sheet
Selection:	M, D, C, or Blank
M	Activate the custom function assigned to the door in this area while the area is Master Armed or Perimeter Armed.
D	Activate the custom function assigned to the door in this area while the area is disarmed.
C	Users can not use a custom function assigned to the door in this area, regardless of the armed state.
Blank	Users can not use a custom function in this area.



When a token or card can also disarm an area, the custom function starts **after** the area disarms.



A user does not require **L## Security Level** or **L## Disarm Level** authority to activate a custom function with a token or card.



Tokens or cards that are used to execute Custom Functions must have a pass code assigned to the corresponding User###.

2.12 Function List

The Function List is accessed when the user presses [MENU] (or the key corresponding to menu on the D1260) while the keypad shows the idle text. Program as many as 32 **M### Function(s)**.

Each CC # keypad address can display a combination of any of the 32 menu items. The D1255 displays one menu item at a time. The D1260 displays up to two menu items at a time. Each keypad address has one Function List. The function name shown in the Functions column in the program record sheet appears in the keypad display in capital letters. For example, WATCH MODE appears when you select **#6 Watch Mode**.

Menu Item

Default: Refer to the program record sheet

Selection: 1 to 32

Enter the menu item number you are programming. The M## Function displays items sequentially in the order they are programmed. The M1 Function is the first function that appears in the menu and M32 Function is the last function that appears when scrolling through the menu.



Failing to program Menu Item 1 causes COMMAND DISABLED to appear in the keypad display.

M## Function

Default: Refer to the program record sheet

Selection: Blank, 1 to 30, 32 to 35, 37, and 128 to 143

Enter the function number indicated in the “#” column of the program record sheet or next to the function in *Section 2.11 User Interface* on page 54.



Function numbers 128 to 143 are custom functions and show the text programmed for **CF ### Text**.



There is no restriction on how many times you can assign a specific function to the menu. By assigning a specific function more than once, you can assign the same function at different keypads so that their order is different in different areas.

M## CC Address 1 [through 8]	
Default:	Refer to the program record sheet
Selection:	Yes or No
Yes	This menu item appears at this keypad address.
No	This menu item does not appear at this keypad address.

Programming this prompt determines at which CC address setting this menu item appears.

2.13 Relay Parameters

Relays provide dry contact (normally open or normally closed) outputs for LED annunciation and other applications as well as wet voltage outputs (12 VDC on or off) for basic alarm system functions (such as Bell Output or Reset Sensors). The applications are endless, but mainly, relays enhance a system's capacity to perform output functions.

- **Panel-Wide Relays:** These relays provide an output related to a panel-wide indication. For annunciation, these relays can indicate system-wide troubles for power and phone. They also provide an overall control panel summary of alarms, troubles, and supervisory conditions.
- **Area Relays:** These relays provide an output by the area to which the relay is assigned. An area can have its own bell and sensor reset indications. Relays can also indicate the area armed state and whether any off-normal conditions, such as a Force Arm, occurred.
- **On Board Relays:** Three on-board 12 VDC voltage outputs provide power when activated on the control panel. These outputs are programmed at the factory as Relays A, B, and C. Typically, Relay A (Terminal 6) is used for the bell, Relay B (Terminal 7) is used for an alternate alarm output (such as another bell), and Relay C (Terminal 8) is used for Sensor Reset (Relays B and C require the optional D136 Relays).
- **Off-Board Relays:** The D9412GV2 can also control 128 (64 for the D7412GV2) dry-contact form C relays when up to sixteen optional D8129 OctoRelay Modules are installed. These relays are used for Area Relay, Panel-Wide Relay, and Individual Point Fault Relays.
- **Relay Follows Point:** Relays can also be used to activate when a point programmed for **P## RlyResp Type** (refer to *Section 4.1 Point Index* on page 81) is off-normal or in an alarm condition.

- **Relay Reports:** When relay activity is reported to the receiver (refer to *Section 2.3 Routing* on page 13), on-board relays are reported as follows:

A = 253
 B = 254
 C = 255

The others report as 001 to 128. The Relay Report is RELAY SET RELAY # rrr when the relay is turned on and RELAY RESET RELAY # rrr when the relay is turned off. Relay Reports are also printed on the local printer and stored in the control panel memory log.

- **Controlling Relays:** Relays can activate depending upon conditions that exist with the control panel. In addition, the user can control relays by using the Chg Relay? function, Relay On/Relay Off skeds, and the Remote Account Manager.

Before programming your relays:

- **Do not** use the CHG RELAYS? function to toggle relays reserved for special functions. Special function relays are Area and Panel Wide Relay functions as well as relays assigned to CC Entr Key Rly and **P## RlyResp Type**.
- Relay C is always on. Assigning any other relay (1 to 128, A or B) deactivates Relay C so this output can be used for other functions. When Relay C is programmed for **A# Rest Sensors**, power is always supplied from Terminal 8 of the control panel.
- **Relay Restoration:** The status of relays after programming or resetting the control panel might restore automatically or require manual restoration. All relays are turned off after the control panel resets. The control panel checks certain relay functions every minute and resumes the correct state after the reset. Other relays must be manually set to the correct state using the Change Relay Function (COMMAND 54).

Relay functions that resume the proper state within one minute:

Alarm Bell	Perimeter Fault
Summary Fire	Summary Trouble
Area Armed	Reset Sensors
Fire Bell	AC Fail
Summary Alarm	Phone Fail
Silent Alarm	Summary SupBurg
Area Fault	Battery Trouble
Summary Fire Tbl	Communications Fail
Watch Mode	Summary SupFire

Relay functions that must be reset manually with Change Relay function (COMMAND 54):

Fail To Close	Force Armed
Duress	Log % Full

2.13.1 Area Relays

Each area can be assigned a unique relay number for each of the events listed in this section.

Area

Default: 1
Selection: 1 to 8

Enter the area number you are programming.

A# Alarm Bell

Default: A
Selection: Blank, 1 to 128 (1 to 64 for D7412GV2), A, B, or C

This voltage output relay activates and provides 12 VDC output when a Non-fire point (**P## Fire** is **No**) assigned to this area activates an alarm.

Burg Time and Burg Pat must be programmed in Bell Parameters. This relay activates according to the bell pattern and remains active until the bell time expires. **P## Silent Bell** must be **No** for the bell to ring upon alarm.

A# Fire Bell

Default: A
Selection: Blank, 1 to 128 (1 to 64 for D7412GV2), A, B, or C

This voltage output relay activates and provides 12 VDC output when a Fire point (**P## Fire** is **Yes**) assigned to this area activates an alarm.

Fire Time and Fire Pat must be programmed in Bell Parameters. This relay activates according to the bell pattern and remains active until the bell time expires. **P## Silent Bell** must be **No** in order for the bell to ring upon alarm.

Although Relay C is a valid entry for **A# Fire Bell**, do not program Relay C for this entry. Use Relay A for the **A# Fire Bell**.

A# Reset Sensors

Default: C
Selection: Blank, 1 to 128 (1 to 64 for D7412GV2), A, B, or C

Unlike the default relay for Alarm Bell and Fire Bell, this voltage-output relay (Relay C) de-activates for 5 seconds when the **Reset Sensors?** function is activated from the keypad or during a Fire Walk Test.

The Reset Sensors time converts from the 5 second default time to the time programmed in **A# Verify Time** (Section 2.9 Area Parameters on page 5) when a point programmed for **P## Alarm Verify** (Section 4.1 Point Index on page 81) enters an alarm condition.

When sharing one relay to reset sensors in two or more areas, you must program the following. Failure to do so causes TROUBLE PT ### for all point types programmed as **P## Resettable**.

- **CC # Scope** must include all areas that share the relay.
- **L## Reset Sensors** authority must be assigned to the pass code that activates the COMMAND 47 or Reset Sensor function.
- **A# Verify Time** must be the same number of seconds for all areas that share the relay.

A# Fail to Close

Default: Blank
Selection: Blank, 1 to 128 (1 to 64 for D7412GV2), A, B, or C

This relay activates when the Closing Window expires for the specified area. It remains active until midnight, another Closing Window starts, or the control panel resets, whichever occurs first. Refer to number 5 in *Programming Tips* on page 74 for addition relay functions.

A# Force Armed

Default: Blank
Selection: Blank, 1 to 128 (1 to 64 for D7412GV2), A, B, or C

This relay activates when this area is Force Armed. It remains active until the area disarms or the control panel resets.



If Force Bypassing is required during Perimeter Arming, this relay does not activate.

A# Watch Mode

Default: Blank
Selection: Blank, 1 to 128 (1 to 64 for D7412GV2), A, B, or C

This relay activates when a Controlled point programmed for **P### Watch Point** is faulted in the specified area while the area is in Watch Mode and the point is not armed. It remains active for 2 seconds after each point is faulted.

A# Area Armed

Default: Blank
Selection: Blank, 1 to 128 (1 to 64 for D7412GV2), A, B, or C

This relay activates when the specified area becomes Master Armed. The exit delay must expire before the relay activates. The relay remains active until the area disarms. It does not deactivate during the entry delay time.

If multiple areas use the same relay, the relay activates when all areas are armed. It deactivates when the first area disarms.

The **A# Area Armed** relay function can provide visual feedback at a key switch station. Attach a LED to the output of a D8129 Module programmed for this function.



Programming a 64 in the Silent Alarm relay for Area 8 causes the **A# Area Armed** relay to activate at the beginning of the exit delay time.

A# Area Fault

Default: Blank
Selection: Blank, 1 to 128 (1 to 64 for D7412GV2), A, B, or C

Activates whenever a controlled (**P### Type 1, 2, 3** only) Perimeter or Interior point is faulted. The relay remains active until all Perimeter and Interior points in the area are normal.



Keyswitch area armed status with LEDs: Use a D8129 Module and connect an LED to indicate that the area is not ready to arm.

A# Duress Relay

Default: Blank
Selection: Blank, 1 to 128 (1 to 64 for D7412GV2), A, B, or C

Activates when a Duress alarm is generated from a keypad assigned to the specified area.



Burg Time needs a bell period programmed and **A# Duress Enable** must be **Yes**. This relay activates when the Burg Bell starts and deactivates when the Burg Bell time ends. The Burg Bell pattern has no effect on this relay function.

A# Perim Fault

Default: Blank
Selection: Blank, 1 to 128 (1 to 64 for D7412GV2), A, B, or C

Activates when a Controlled Perimeter point (**P### Type 1**) assigned to the specified area is faulted, regardless of the armed state of the area. This relay provides a steady output until all Perimeter points in the area return to normal.



This relay does not activate on interior faults. To detect all area point faults, program all points as Perimeter points in the area where this relay is assigned.

A# Silent Alarm

Default: Blank
Selection: Blank, 1 to 128 (1 to 64 for D7412GV2), A, B, or C

This relay activates when a point assigned to the specified area and programmed for **P### Silent Bell** goes into alarm.

Programming Tips

1. Burg Time needs a programmed bell period. This relay activates according to the bell pattern and remains active until the bell time expires or a valid pass code is entered.
2. Programming 64 in the Silent Alarm Relay for Area 8 causes the Area Armed or Perimeter Armed Relay (refer to Programming Tip 5) to activate at the beginning of the exit delay time.
3. Programming a non-zero value in the Silent Alarm Relay for Area 5 enables Ground Fault Detect on the D9412GV2 or D7412GV2 Control Panel. Refer to *Ground Fault Detect* in the *D9412GV2/D7412GV2 Operation and Installation Guide* (P/N: F01U003641).
4. When enabled, **Fire Trouble Resound** resounds the Fire Trouble condition at 12:00 PM or 12:00 AM if the Fire Trouble condition still exists. It does not, however, retransmit the Fire Trouble condition. The Fire Trouble Event is only sent, if programmed to do so, when it occurs.
 - To disable the Fire Trouble Resound feature, program a 0 in the Silent Alarm Relay entry for Area 6.
 - To enable the Fire Trouble Resound feature at 12:00 PM, program a 61 in the Silent Alarm Relay entry for Area 6.
 - To enable the Fire Trouble Resound feature at 12:00 AM, program a 62 in the Silent Alarm Relay entry for Area 6.
5. Perimeter Armed Relay, when enabled, turns the Fail to Close Relay function into a Perimeter Armed Relay function.

To change the Fail to Close Relay into a Perimeter Armed Relay function, set **A7 Silent** to 63. Set **A# Fail to Close Relay** to the area to be Perimeter Armed. Refer to Programming Tip 2 for additional information.



Programming a value other than 0, 61, or 62 enables the Fire Trouble Resound feature at 12:00 AM.

2.13.2 Panel-Wide Relays

The following eleven relay options activate when they occur anywhere in the control panel. They are not restricted by area boundaries.

AC Failure

Default: Blank
Selection: Blank, 1 to 128 (1 to 64 for D7412GV2), A, B, or C

Activates when the control panel responds to an AC power failure as programmed in **AC Fail Time** in *Section 2.5 Power Supervision* on page 25. This relay automatically resets when AC power restores.



Use this relay to create audible annunciation. Enable the keypad's trouble sounders for all applications except commercial fire systems.

Battery Trouble

Default: Blank
Selection: Blank, 1 to 128 (1 to 64 for D7412GV2), A, B, or C

Activates when battery voltage falls below 85% of capacity (12.1 VDC) for a fully charged (13.8 VDC) battery, or when the battery is in a missing condition. This relay automatically resets when battery power restores.



Use this relay to create audible annunciation. Enable the keypad's trouble sounders for all applications except commercial fire systems.

Phone Fail

Default: Blank
Selection: Blank, 1 to 128 (1 to 64 for D7412GV2), A, B, or C

Activates when a telephone line failure occurs. A time must be entered in Ph Supv Time (refer to *Section 2.2 Phone Parameters* on page 10) for this relay to activate. This relay resets automatically when restoration of the phone line(s) occurs.

Comm Fail

Default: Blank
Selection: Blank, 1 to 128 (1 to 64 for D7412GV2), A, B, or C

Activates when a control panel cannot communicate a report after making ten attempts to each routing destination. At the same time, COMM FAIL RT ## displays at the keypad. This relay automatically resets when a report is sent successfully.



Use this relay to report primary digital report failure to an alternate communication device.

Log % Full

Default: Blank
Selection: Blank, 1 to 128 (1 to 64 for D7412GV2), A, B, or C

Enter the number of the relay that activates when the log reaches the programmed percentage of its capacity as programmed in RPS Parameters program item Log % Full. This relay provides a steady output until a Get Log and Set Pointer is executed from the remote programming software (RPS).

Summary Fire

Default: Blank
Selection: Blank, 1 to 128 (1 to 64 for D7412GV2), A, B, or C

Enter the number of the relay that activates when any Fire point in the system (*P## Type 0, P## Fire Yes*) enters into alarm. This relay provides a steady output until all Fire points in the system return to normal.

Summary Alarm

Default: Blank
Selection: Blank, 1 to 128 (1 to 64 for D7412GV2), A, B, or C

Enter the number of the relay that activates when a Non-fire point enters into alarm. This relay provides a steady output until the alarm is acknowledged by a valid pass code, then cleared from alarm memory with an acknowledgment at the keypad.



This relay does not activate for silent and invisible alarms.

Summary Fire Tbl

Default: Blank
Selection: Blank, 1 to 128 (1 to 64 for D7412GV2), A, B, or C

Activates when any Fire point in the control panel is in trouble, or if a Fire Supervision point is missing. This relay provides a steady output until all Fire points restore to a normal condition.

Summary SupFire

Default: Blank
Selection: Blank, 1 to 128 (1 to 64 for D7412GV2), A, B, or C

Activates when any Fire Supervisory point in the control panel is in a supervisory condition (off-normal). This relay provides a steady output until all Fire Supervisory points are restored to a normal condition.

Summary Trouble

Default: Blank
Selection: Blank, 1 to 128 (1 to 64 for D7412GV2), A, B, or C

Activates when any Non-fire point in the control panel is in a trouble condition. This relay provides a steady output until the user at the keypad acknowledges the trouble.

Summary SupBurg

Default: Blank
Selection: Blank, 1 to 128 (1 to 64 for D7412GV2), A, B, or C

Activates when any Non-fire Supervisory point in the control panel is in a supervisory condition, or if a Supervisory Burg point is missing. This relay provides a steady output until the user at the keypad acknowledges the condition.

Notes

3.0 RADXUSR1/RADXUSR2

3.1 Pass Code or Token Worksheet

These programming items assign:

- a pass code to user groups 001 to 249,
- areas by authority level, and
- a User Group Window.

Two handlers in the D5200 Programmer are used to program the users:

- RADXUSR1 Handler programs users 000 to 124.
- RADXUSR2 programs users 125 to 249 (D9412GV2 only).

3.1.1 User Groups

For the D9412GV2, there are 249 groups (99 groups for the D7412GV2) consisting of one user with a pass code and token (master) and three users with tokens or cards but not a pass code (sub-user). All users in the group share the same authority level as the master user.

3.1.2 Pass Codes

In a control panel with factory default settings, only the master user has an assigned pass code. A pass code can be three to six digits. Entering three digits in **User ###** chooses the user. Programming the **U001 Passcode** assigns a pass code to the master user. Sub-users cannot use the pass code. Do not assign tokens or cards to User ID 0 (zero), which is reserved for the service pass code.

Pass Code Tamper

If a user enters six consecutive invalid pass codes at the same keypad, the control panel sends a User Code Tamper report to the central station. The invalid pass code count resets when a valid pass code is entered at the same keypad. Refer to R# Usr Code Tamper in *Table 9* on page 16 for information on enabling this report.

3.1.3 User Group Window

Use **U### User Group** to enable and disable the **U### Passcode** for up to eight different time periods throughout the day. Assign the number (1 to 8) programmed in **U### User Group** to a **User Windows #**. If the user is outside a window, COMMAND DISABLED appears on the keypad after the user enters the pass code and presses [ENTER].



This window does not affect tokens and cards. It only affects the pass code of the master user.



When using the Add/Change User function at the keypad, the authority levels and the changes made affect the master user's pass code and the entire group's token or cards.

When using the ACCESS CTL LVL function at the keypad, the whole group is affected by whether or not the level is on or off for access control functions only.

When using the DELETE USER? function, the whole group is deleted. You cannot delete each user within the group individually. Use the ADD/CHG USER? function to change a user token or card instead of deleting the whole group.

3.1.4 User Name

Each user group can be assigned one **U### Name**. This name is logged and sent to the central station for all the users in the group. The user ID is used to differentiate which user's token or card was executed.



When using a D1260 Keypad, User 249 text is used for contact information text (such as telephone numbers). If a D1260 is installed on the system, do not use User 249 for user ID information.

3.1.5 Tokens and Cards

The master user assigned the pass code can also be assigned a token or card by programming the **U### Mstr Site** and **U### Mstr Crd Data**.

Three more tokens or cards are assigned to the user group for sub-users using the **U### SU# Site** and **U### SU# C/D**.

3.1.6 Reporting and Logging

Modem Format must be **Yes** for the following reports sent to the central station. Regardless of the reporting format, they log and print at the local printer as shown in *Figure 4* on page 78. Each sub-user is identified by the master user's three-digit number plus an extension of 0, 1, 2, or 3. These numbers are called Sub-user ID Codes.

Figure 4 shows all the users for User Group 122 as they would appear.

Figure 4: User Group 122 Example

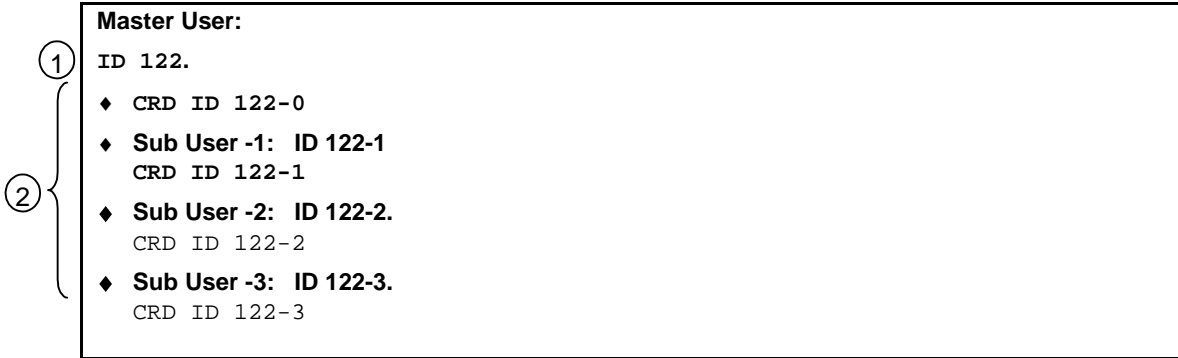

- 1 - User pass code
- 2 - User token or card



In reporting systems using modem format, all three digits of the User ID Code are transmitted to the central station with appropriate reports. Central station automation computer systems can accept only Zonex and Comex style User IDs. Refer to **Point/User Flag** in *Section 2.1 Phone* on page 9.

In BFSK, only one number is transmitted. This number represents a group of ten users as shown in *Table 28*. Users 100 through 249 do not report in BFSK format.

Table 28: BFSK User Code Report

User Code	User Code	User Code	User Code	User Code	User Code	User Code	User Code	User Code	User Code
000 to 009	010 to 019	020 to 029	030 to 039	040 to 049	050 to 059	060 to 069	070 to 079	080 to 089	090 to 099
BFSK Report 0	BFSK Report 1	BFSK Report 2	BFSK Report 3	BFSK Report 4	BFSK Report 5	BFSK Report 6	BFSK Report 7	BFSK Report 8	BFSK Report 9

User ###

Default: 001
Selection: 000 or 001 to 249 (001 to 099 for the D7412GV2)

Enter the User number you are programming.



User 000 is the Service Authority Level (Level 15). You cannot change the programming for user 000.

Only the Service Authority Level (User 000) can delete User 000. When a user other than User 000 tries to delete the pass code for User 000, the keypad displays NOT IN USE.

User 000 cannot be added or changed at the keypad whether it exists or not.

U### Passcode**Default:** Refer to the program record sheet**Selection:** Three to six digits (0 to 9)

Enter three to six digits to enable a pass code for the master user in this group.



User I.D.000 is the reserved user for service personnel. The default service pass code is 123.

The programmer does not allow you to enter any pass code number that might conflict with a duress pass code. The programmer reserves the actual duress pass code and the duress pass-code number plus 1, duress pass-code number plus 2, duress pass code-number minus 1, and duress pass-code number minus 2.

If **Duress Type** is set to 1, pass codes within a range of 1 for existing pass codes cannot be entered. If **Duress Type** is set to 2, pass codes within a range of 2 cannot be entered. This rule applies even if duress is disabled. For example, with **Duress Type** set to 2, when a pass code of 654321 is entered, 654322, 654323, 654320, and 654329 are reserved and are not available to other users.



The authority to silence a bell is granted to all pass codes regardless of their authority level assignments. A user pass code can silence a Fire or Burg bell as long as any authority level is assigned to the area where the bell can be silenced.

U### User Group**Default:** Blank**Selection:** Blank, 1 to 8

Create a group of up to 249 users (99 for the D7412GV2) whose combinations can be enabled and disabled using an automatic user window. This is the number entered into the **W# User Group** for any active **W# User Window**. Multiple windows can be programmed for one user group (up to eight) within one 24-hour period. For example, if User Group 1 has a window running from 8:00 AM (start time) to 4:00 PM (stop time), the users for that group can use their pass codes only between that time. Between 4:00 PM that day and 8:00 AM the next day, the users cannot use their pass codes.



To enable this user's pass code at all times, leave **U### User Group** blank.

User Group Window times cannot be changed from the keypad. When a window is assigned to a user group, the users in that group rely on the window to be active (within the start and stop times) for their pass codes to function. The only way to disable the window is by reprogramming the control panel from the D5200 or remote programming software (RPS).

U### Area 1 [through Area 8] Auth**Default:** Refer to the program record sheet**Selection:** 1 to 14 or Blank

Assign an authority level to the user for this area. Blank means the user has no authority in this area.

U### Name**Default:** Refer to the program record sheet**Selection:** Sixteen alphanumeric characters

Enter Alphabetic-characters A to Z in capital letters
Period (.), comma (,), percent (%), parentheses [], equal (=), greater or less than (<>), exclamation (!), braces {}, apostrophe ('), carat (^), grave accent (`), tilde (~), semi-colon (;), and colon (:) are not allowed.

Enter up to sixteen characters of text for this user group.



Programming this group with a departmental, team, or function name identifies all the users in this group in a function related manner, such as ENGINEERING.

Card Data Format

The D9412GV2/D7412GV2 and D9210B Controller comply with the 26-bit Wiegand card data format. In essence, the format consists of 26 bits (3.2 bytes) of data. The first bit is used for the even parity. The next 8 bits (first byte) is used for the **U### Site Code**. The next 16 bits (second and third byte) are used for the **U### Card Data**. The last bit is used for the odd parity.

As long as the reader and the tokens or cards you use are compatible with 26-bit Wiegand format, they function with this system.

Use only the readers identified as being compatible with the D9210B door control module. Refer to the *D9210B O/I Manual* (P/N: 32206) for information on these readers.

For more information, refer to the Security Industry Association (SIA) Access Control 26-bit Wiegand Reader Interface Standard.

U### Mstr Site

Default: Blank

Selection: 000 = (0) to 254 or Blank (255)

Master User ### Site Data: Enter the first three decimal numbers on the back of the token or card. This is the first byte (bits 2 through 9) of data for a 26-bit Wiegand card. This is called the site number. Tokens and cards with a site code of 255 are not compatible with the D9412GV2/D7412GV2 Control Panels



Converting hexadecimal to decimal: If your card label contains letters as well as numbers, the number is hexadecimal.* Convert the hexadecimal number to decimal using your calculator. If you cannot convert in this way, use the reader and the Add/Chg User? Function to add the tokens or cards.

Perform the following test to confirm that you can convert properly:

Use 319EB0 as the hexadecimal number. On your calculator, press [HEX]. Enter all the hexadecimal characters into the calculator. Press [DEC] and your hexadecimal characters convert to the following eight digits: 03251888. The site number is 032. Enter it in **U### Mstr Site**. Your card data is 51888. Enter it into **U### Mstr Crd Data**.

* A hexadecimal number can contain all numerals. If the code does not work, try converting the number from hexadecimal to decimal.



Always tag your tokens before adding them to the system so you do not mix them up. Use the CRD ID ###-# number to index them.

U### Mstr Crd Data

Default: Blank

Selection: 00000 = (0) to 65534 or Blank (65535)

Master User ### Card Data: Enter the remaining five decimal numbers on the back of the token or card. This is the second and third byte (bits 10 through 25) of data for a 26-bit Wiegand card. This is called the card data.

You must program **U### Mstr Site** before programming this prompt.

U### SU1 through SU3 Site

Default: Blank

Selection: 000 = (0) to 254 or Blank (255)

Sub-users one through three site data.

U### SU1 through SU3 C/D

Default: Blank

Selection: 00000 = (0) to 655354 or Blank (65535)

Card data for sub-users one through three.

4.0 RADXPNTS

4.1 Point Index

Use this programming module to construct personality types for points used in the system. The Index numbers are used in Point Assignments. Each unique point index number determines the control panel's responses to specific conditions occurring on the Protective points.

The NEW RECORD program contains default entries and descriptions that match RPS defaults for point indexes. Refer to the *D9412GV2/D7412GV2 Program Record Sheet* (P/N: F01U003635) for defaults.

Point Index

Default: 1
Selection: 1 to 31

The number of the point personality you are programming. You can define up to 31 individual personalities.

P## Type

Default:	Refer to the program record sheet
Selection:	0 to 9
P ## Type	Description
0	<p>24-hour: A 24-hour point is not turned on and off from a keypad. 24-hour points are armed all the time, and can be used for fire protection (refer to the P ## Fire Point prompt in <i>Section 4.2 Point Responses</i> on page 85), panic, medical, and police alerts.</p> <p>24-hour points can be programmed as bypassable. Consider the application carefully before using the bypassable option. Program bypassable 24-hour points to Buzz on Fault.</p> <p>When a 24-hour point is bypassed, send the report as it occurs. If the area contains all 24-hour points, the area is never armed or disarmed. A Deferred Bypass Report is not sent.</p> <p>24-hour protection for fire doors, roof hatches, and so on. Instead of programming this type of protection as a 24-hour point, consider using a Perimeter point type with a Point Response of 9 to E. 24-hour points do not show faults when an arming function is entered, but Perimeter points do. When programming this type of protection, consider also using the Buzz on Fault and Local While Disarmed options.</p>
1	<p>Perimeter: Perimeter points are armed with all arming functions. Points programmed as perimeter can also be armed as a group (using Perimeter-Arming functions) separately from points programmed as interior. This lets the user partially arm the system to establish Perimeter protection while occupying the interior of the protected premises.</p> <p>Perimeter points can be programmed to activate entry delay time. If the point activates entry delay, it can also activate an entry tone.</p> <p>When a Perimeter point is programmed for entry delay, entry delay time is always provided. If the area is in entry delay when a second Perimeter point is faulted, the control panel compares the remaining entry delay time to the time programmed for the second Perimeter point. If the second Perimeter point's entry delay time is less than the remaining time, it shortens the entry delay time.</p> <p>Perimeter points programmed for an instant point response, generate an alarm immediately when faulted, even during entry or exit delay.</p>

P ## Type Selection	Description
2	<p>Interior: Interior points are armed only by master arming the area. They are not armed when using Perimeter Arming functions. These points are typically used to monitor interior detection devices such as interior doors, motion detectors, photoelectric beams, and carpet mats.</p> <p>Instant Interior Points: Interior points are usually programmed for an instant alarm (refer to <i>Section 4.2 Point Responses</i> on page 85). Points programmed for instant alarms generate alarms immediately, even during entry or exit delay.</p> <p>Delayed Interior Points: Interior points can be programmed for a delayed point response. A delayed response means that if the point is faulted while the area is armed, it activates entry delay. It does not generate an alarm until entry delay expires.</p> <p>When an Interior point is programmed for entry delay, entry delay time is always provided. If the area is in entry delay when a fault occurs for the Interior point, the control panel compares the remaining entry delay time to the time programmed for the Interior point. If the Interior point's entry delay time is less than the remaining time, it shortens the entry delay time.</p> <p>Delayed points can also activate an entry tone at the keypad (refer to the <i>P## Ent Tone Off</i> prompt in <i>Section 4.2 Point Responses</i> on page 85).</p> <p>In some cases, you might need to create an Interior point that causes an instant alarm if the entry delay is not started first. Use Interior Follower to create this type of protection.</p>
3	<p>Interior Follower: Interior Follower points are armed only by master arming the area. They are not armed when using Perimeter-Arming functions.</p> <p>An Interior Follower point does not create an alarm if it has a fault while the area is in entry delay. An Interior Follower does not change the amount of remaining entry delay time.</p> <p>If no entry delay is in effect when a fault occurs for the Interior Follower, it creates an instant alarm.</p> <p>You must program a delayed Point Response (4, 5, 6, 7, or 8) for an Interior Follower point. The control panel ignores the entry in <i>P## Entry Delay</i> for an Interior Follower point.</p> <p>Note:</p> <p>Increasing the debounce count for Interior Follower points might be necessary to prevent Interior Follower points from entering into alarm before the control panel recognizes that a Perimeter Delay point was faulted. Program the Interior Follower's debounce for one number higher than the debounce count on Perimeter delay</p>

P ## Type	Description
4*	<p>Keyswitch Maintained: Program <i>P## Pt Response</i> as 1. Do not connect initiating devices to a Keyswitch point.</p> <p>Normal: The area is disarmed.</p> <p>Short: When this point changes from normal to open, the area arms.</p> <p>Open: A short is a trouble when the area is disarmed. A short is an alarm when the area is armed. When this point changes from shorted to normal or open, it restores.</p> <hr/> <p>Program Point Response as 2, the point responds as follows:</p> <p>Normal: When this point changes from open to normal, the area arms.</p> <p>Open: The area is disarmed.</p> <p>Short: A short is a trouble when the area is disarmed. A short is an alarm when the area is armed. When this point changes from shorted to normal or open, it restores.</p> <p>Trouble and Restoral Reports are not sent if <i>Local While Disarmed</i> is Yes.</p> <p>Alarm and Restoral Reports are not sent if <i>Local While Armed</i> is Yes.</p>
5*	<p>Keyswitch Momentary: Used for area arming and disarming. <i>Point Response</i> must be programmed 1. Do not connect initiating devices to a Keyswitch point.</p> <p>N→S→N: When this point momentarily changes from normal to shorted to normal, it toggles the armed state of the area.</p> <p>Open: An open is a trouble while the point is disarmed. An open is an alarm while the point is armed.</p> <p>When this point changes from open to normal, it restores.</p> <p>Trouble and Restoral Reports are not sent if <i>Local Disarmed</i> is Yes.</p>
6*	<p>Open/Close Point: Used for point arming and disarming. <i>Point Response</i> must be programmed 1. Local bells are silenced through the keypad.</p> <p>Normal: The point is armed and sends a Point Closing Report. A Point Closing Report is not sent if Local Armed is Yes.</p> <p>Open: An open is an alarm when the point is armed. An open is a trouble when the point is disarmed. Alarm and Restoral Reports are not sent if <i>Local Disarmed</i> is Yes.</p> <p>Short: The point is disarmed and sends a Point Opening Report. A Point Opening Report is not sent if <i>Local Armed</i> is Yes.</p>

* **Keyswitch Points: Special rules apply to points used for Keyswitch functions.** These special point types do not respond the same way to the point response entry as Point Types 1, 2, and 3. Responses for Keyswitch point types are described in *Section 4.2 Point Responses* on page 85..

P ## Type Selection	Description
7*	<p>D279 (O/C Non-Priority): The D279 provides point arming and disarming independent of the area arm state. A non-priority D279 point arm state does not affect the area arm state. Point Response must be programmed 1. Local bells are silenced through the keypad. For bell control at the D279, use <i>P## Type 8</i>.</p> <p>Open the W1 jumper on the D279 to send Point Opening and Point Closing Reports. If the D279's W1 jumper is closed, no Open or Close Report is sent, regardless of control panel programming.</p> <p>Normal: The point is armed and sends a Point Closing Report. Point Closing Report is not sent if Local Armed is Yes.</p> <p>Open: The point is disarmed and sends a Point Opening Report. A Point Opening Report is not sent if Local Armed is Yes.</p> <p>Short: A short is an alarm when the point is armed. A short is a trouble when the point is disarmed. Alarm and Restoral Reports are not sent if Local Disarmed is Yes.</p>
8*	<p>D279 (O/C Priority): The D279 provides point arming and disarming independent of the area's arming state. A priority D279 point must be armed before an area can be armed. Program Point Response as 2.</p> <p>Open the W1 jumper on the D279 to send area Opening and Closing Reports as programmed in Area Parameters and to provide bell control. If the D279's W1 jumper is closed, no Area Open or Area Close Report is sent, and alarm bells can only be silenced from a keypad, no matter how the control panel is programmed.</p> <p>Normal: When this point changes from open to normal, the area arms.</p> <p>Open: The area is disarmed. The alarm bell silences if an alarm occurred while the area was armed.</p> <p>Short: A short is a trouble while the area is disarmed. A short is an alarm while the area is armed. When this point changes from shorted to normal or open, it restores.</p>
9*	<p>Easikey: This point is programmed for access. Program Point Response as 1. If the system is Master Armed or Perimeter Armed (with or without delays), presenting a valid token to the Easikey reader shorts the point and disarms its assigned area. Presenting a valid token in a disarmed state does not clear trouble or alarm memory or rearm the area.</p>

* **Keyswitch Points. Special rules apply to points used for Keyswitch functions.** These special point types do not respond the same way to the point response entry as Point Types 1, 2, and 3. Responses for keyswitch point types are described in *Section 4.2 Point Responses* on page 85.

4.2 Point Responses

4.2.1 Applications for Point Responses 9, D, and E:

Combine Point Responses 9, D, and E with Perimeter point types to create more flexible 24-hour protection. Unlike 24-hour points, a faulted Perimeter point with a Point Response of D and E displays at the keypad when arming. Like a 24-hour point, a point programmed this way can generate alarms whether the area is armed or disarmed.

Combining Point Response 9 with the Local While Disarmed feature provides off-site reporting when the area is armed, but only local alarm annunciation when the area is disarmed.

Combining Point Response 9 with the Local While Armed feature provides off-site reporting when the area is disarmed, but only local alarm annunciation when the area is armed.

Point Response E: Use this setting for Zonex or ASIC motion detectors. The control panel can report troubles while Master Armed.

Point Response F: Does not sound at local keypads but activates *P## RlyResp Type 1* and keypad faults. To annunciate the off-normal state at a keypad, program *Disp as Dvc* as **Yes** and optionally set *BuzzOn Fault* as 1 or 2. This point response does not generate alarms or activate an alarm relay.

Point Response 8, 9, A, B, and C provide supervisory (24-hour) reporting.

4.2.2 Characteristics of a Fire Point:

Reporting: When a group of events occurs, the control panel routes and prints out Fire Reports first.

Visual Annunciation: FIRE TROUBLES continues to scroll until the trouble clears. When acknowledged, a FIRE TROUBLE scroll notifies the end user that a Fire point, or group of Fire points, is still in trouble. Panel-Wide Relays, *Summary Fire*, and *Summary Fire Tbl* activate if a relay is assigned when any Fire point enters into alarm or is in trouble.

Audible Annunciation: A Fire point activates the *A# Fire Bell* relay programmed in Relay Parameters. The amount of time and the pattern of the relay activation is programmed by area in *Bell Parameters*, *A# Fire Time*, and *A# Fire Pat*.

Supervisory: A Fire point can send a Fire Supervisory Report and activate the *Summary Fire Sup* and *Summary Fire Tbl*, Panel-Wide Relays with a *P## Response* of 8-9-A-B-C.

Alarm Verification: A Fire point can delay an alarm by the length of time programmed in *A# Verify Time* in the Area Parameters. Combined with *A# Resettable*, a Fire point also resets the electrical circuit for the amount of time programmed.

Reset Sensor: A fire device that requires resetting can be manually reset using the reset sensor relay for the area to which it is assigned.

Fire Walk: Use the Fire Walk function to test Fire points in the system. The Fire Walk Test automatically resets each point for five seconds when the point is activated, and rings the Fire Bell for two seconds.



To provide an audible tone for a restored Fire Supervisory point, use *P## RlyResp Type 1* and connect the corresponding relay to a visual annunciator.

P## Pt Response

Default: Refer to the program record sheet

Selection: 0 to F

Controlled (Non-24-Hour Points)

Point Response		0	1	2	3	4	5	6	7	8	9	A	B	C	D	E	F
Armed	Open	I	I	I	I	D	D	I	I	D	I	I	I	I	I	T	
Armed	Short	I	I	I	I	I	I	D	D	D	I	I	I	I	I	I	
Disarmed	Open		T		T				T		I	I	T	I		T	
Disarmed	Short			T	T		T				I	T	I		I		

24-Hour Points

Point Response		0	1	2	3	4	5	6	7	8	9	A	B	C	D	E	F
Open		I	T	I	T			I	T	S	T	S		S			
Short		I	I	T	T	I	T			T	S		S	S			

- Key:
- I = Instant alarm
 - D = Delayed alarm
 - T = Trouble
 - S = Supervisory
 - Blank = Audible or visual response

Example of Controlled point:

Point Type = 1

Point Response = 8

Perimeter point with delayed alarm response when armed (opened or shorted) and no response when disarmed.

Example of 24-hour point:

Point Type = 0

Point Response = 8

24-hour point with supervisory response when open and a trouble response when shorted.



When programming the point response for Inovonics Wireless Transmitters, regardless of how the transmitter is programmed, the D8125INV Wireless Interface always sends the off-normal state to the control panel as a short and a tamper condition as an open. As a result, typical point responses for the Inovonics transmitters would include 0, 1, 6, 7, and E for controlled points, and 0 and 1 for 24-hour Burg points. When programming a transmitter as a Fire point, use a point response of 1.

Wireless transmitters are **not** UL Listed with the D9412GV2/D7412GV2 in fire or burglary applications. Inovonics Wireless Transmitters, when used with the D8125INV Wireless Interface on a 9000GV2 Series control panel, are not UL Listed for use with fire or burglary applications.



With Supervisory Pt Response (S = Supervisory), the BFSK format does not transmit fire supervisory or Non-fire Supervisory Events. Modem format must be used with Supervisory Point Responses.

P## Entry Delay

Default: Refer to the program record sheet
Selection: 5 seconds to 600 seconds

Use this option to enter the amount of entry delay time that a user has after faulting a Controlled point (*P## Type 1, 2, 3*) with a delayed response (D) (*P## Pt Response*) of 4, 5, 6, 7, or 8. DISARM NOW appears for the duration of the time programmed when the point is faulted in the delay condition.

 The D1255 alternates between DISARM NOW and the point text of the point that caused the area to enter into entry delay.

If this time expires before disarming, or if the point is faulted to an instant response (I), an alarm occurs.

 Make entries in 5 second increments. The programmer does not allow off-increment entries.

 If another Perimeter or Interior Follower Delay point trips while the area is already in entry delay, the control panel adjusts the delay time to the Delay point with the least amount of delay time.

When a user enters an area, a Perimeter point is faulted and the entry delay starts. If an interior point must fault during entry delay to allow the user to disarm the area at a keypad, program *P## Type* as 3 (Interior Follower).

P## Ent Tone Off

Default: No	
Selection: Yes or No	
Yes	Defeat the entry delay tone when this perimeter point is faulted. This is intended for use with points set to <i>P## Type 1</i> (Perimeter).
No	A tone sounds at keypads when this point starts entry delay.

This option enables and disables the entry delay warning tone for this point.

 Do not set points to **No** if they are actually used to notify the user to disarm the system. The possibility of false alarms increases if the entry delay warning is not used.

 Entry Tone can also be turned off when programming your CC Entry Tone, in *Section 2.10 Keypad (Command Center)* on page 45, that allows you to manage the tone by keypad.

 You might want to disable the entry tone in high security applications where you do not want to annunciate entry delay.

P## Silent Bell

Default: No	
Selection: Yes or No	
Yes	Activate the Silent Alarm relay when this point enters into alarm. Keypads do not sound the alarm tone for Non-fire points.
No	Activate either the Fire Bell relay or Alarm Bell relay and sound the alarm tone at keypads when this point enters into alarm. If this is a Fire point, it activates the Fire Bell relay programmed in Relay Parameters. Otherwise, it activates the Alarm Bell relay. The amount of time and pattern of the relay activation is programmed by area in Bell Parameters.

 If you want this point to ring the bell because the message failed to reach the central station receiver, program *P## Audible After 2 Failures* as **Yes**.

P## Ring Til Rst

Default: No	
Selection: Yes or No	
Yes	The relay programmed to provide fire alarm output for this point cannot be de-activated until the point restores to normal.
No	The relay programmed to provide fire alarm output for this point can be de-activated before the point restores to normal.

Use this option to determine if the bell continues to ring until the Fire Bell time expires. The point returns to a normal condition when the user acknowledges the alarm to silence the bell.

 If the point restores and the fire alarm is not silenced from the keypad, the fire alarm output continues until Fire Bell time expires. If the point does not restore, the fire alarm output continues even after bell time expires.

 Use this option for fire applications to meet the requirement that audible alarms cannot be silenced until the fault condition clears or the Fire Bell time expires.

P## Audible After 2 Failures

Default: No	
Selection: Yes or No	
:	
Yes	A# Burg Alarm relay activates after two failed attempts.
No	P## Silent points do not cause the A# Burg Alarm relay to activate even if the report does not get to the central station receiver.

When set to Yes, if the report fails to reach the central station after two attempts, a silent alarm rings the **A## Burg Alarm** bell. A silent alarm is generated when a point with **P## Silent** set to **Yes** is faulted while armed.

 When a point programmed for **P## Silent Bell** is faulted, the timer for the **A# Burg Time** starts, even though the bell is not yet ringing. As much as three minutes can elapse before the second attempt fails. Ensure that **A# Burg Time** is programmed to provide the amount of bell time you need, minus the additional three minutes that might elapse before the bell actually begins to ring.

P## Invisible Pt

Default: Refer to the program record sheet	
Selection: Yes or No	
Yes	Keypads do not display alarm activity from this point.
No	Activity from this point is visible at the keypads.

Use this option to determine whether the point appears in the keypad display upon an alarm condition. For LED keypads, the LED does not illuminate upon an alarm condition. Point text appears and annunciation is made for Invisible points programmed for a trouble condition in point response.

 To prevent the keypad alarm tone and the **A# Burg Alarm** bell from sounding, program **P## Silence Bell** as **Yes**.

 If a user enters a valid pass code while a bell is ringing for an invisible alarm, the keypad shows ALARM SILENCED.

P## Buzz On Fault

Default: Blank		
Selection: Blank, 1 to 3		
Selection	Operation for Controlled Points (Point Types 1, 2, and 3)	Operation for 24-hour Points (Point Type 0)
Blank	The point buzzes at the keypad only if it enters into the trouble condition indicated in the P## Point Response .	Same as as operation for controlled points
1	The point generates a Buzz Until Restore at the keypad for any fault condition while the point is disarmed . The buzz continues until the point restores and the user acknowledges the condition using a pass code or COMMAND 4. The point must be normal before the user can silence the buzz.	The point generates a Buzz Until Restore at the keypad for any fault condition regardless of the armed state . The buzz continues until the point restores and the user acknowledges the condition using a pass code or COMMAND 4. The point must be normal before the user can silence the buzz.
2	The point buzzes at the keypad for any fault condition when the point is disarmed . The user can silence the buzz before the point returns to normal.	The point buzzes at the keypad for any fault condition regardless of the armed state . The point does not need to be normal before the user can silence the buzz.
3	The point buzzes at the keypad for any fault condition when the area is disarmed. The user cannot silence this buzz, but it silences automatically when the point is restored. If the fault condition results in a trouble response, the keypad continues to buzz even after the user acknowledges the condition if the fault is still present.	The point buzzes at the keypad for any fault condition regardless of the armed state . The user cannot silence this buzz, but it silences automatically when the point is restored. If the fault condition results in a trouble response, the keypad continues to buzz even after the user acknowledges the condition if the fault is still present.



Points bypassed (by the user, Sked, Swinger Bypass, or RPS) do **not** generate a Buzz On Fault condition at the keypad.



The buzz does not automatically stop when the point is restored when using Option 1 or 2. The user must acknowledge the buzz before the buzz stops. However, when using Option 3, the buzz stops automatically when the point restores to normal without user intervention.

P## Watch Point**Default:** Refer to the program record sheet**Selection:** Yes or No

Yes	Activates Watch Mode responses if the point is faulted while the control panel is in Watch Mode.
No	Does not activate Watch Mode responses for this point.

Use this option to allow a Controlled point to generate a watch tone while the area is disarmed and not faulted to a trouble or alarm condition.

P## RlyResp Type

Default: Refer to the program record sheet	
Selection: Blank, 1 to 2	
Blank	Point state does not affect the operation of the corresponding relay.
1	Relay Follows Point: The relay corresponding with this point activates when the point is faulted to any off-normal condition, even if the point is bypassed. The relay automatically resets when the point returns to normal.
2	Relay Latches: The relay corresponding with this point latches when the point enters into an alarm condition. This relay provides a steady output until the alarm is acknowledged by a valid pass code, then cleared from alarm memory with an acknowledgment from the keypad.

Use this option to cause a relay (1 to 127 for D9412GV2; 1 to 64 for D7412GV2) to respond when a corresponding point with the same number (1 to 127) is faulted. This requires connecting D8129 OctoRelays to Zonex Bus 1 and Zonex Bus 2 (D9412GV2 only). Refer to the address settings on the back of the *D9412GV2/D7412GV2 Program Record Sheet* (P/N: F01U003635).

 Point 128 is reserved for use other than an actual point. Only the first 127 points can have an associated relay. Relays are not available for Points 129 to 247.

 Do **not** use the Chg Relays? function to toggle relays reserved for special functions. Special function relays are Area and Panel Wide Relay functions as well as relays assigned to CC Entr Key Rly and **P## RlyResp Type**.

P## Disp as Dvc

Default: No	
Selection: Yes or No	
Yes	Display CHECK DEVICE when this point is off-normal.
No	Do not display CHECK DEVICE when this point is off-normal.

Use **P## Disp as Dvc** to cause the keypad to display CHECK DEVICE when a point is off-normal or is acknowledged after going into alarm.

 Use this function for devices with a dry contact output that faults a point when the device is in a trouble condition.

P## Local While Disarmed

Default: Refer to the program record sheet	
Selection: Yes or No	
Yes	Suppress Alarm, Trouble and Restoral* Reports from this point while the area to which it is assigned is disarmed.
No	Send event reports occurring from this point while the area is disarmed.

* Transmission of Restoral Reports continues if the alarm, trouble, or bypass (by Sked, RPS, or Swinger bypass) condition occurred when the area disarmed, and the point restored.

Use this option to allow a Controlled point (**P## Type 1, 2, 3**), to report Alarms, Troubles, and Restoral Reports only when the area is armed. This prompt does not affect local annunciation.

 Local While Disarmed suppresses all reports from 24-hour points. Do not use P## Type 0 for this prompt. Remember that this option works only for Disarmed points, and a Type 0 is a 24-hour Always Armed point. Instead, choose any type other than 0, and use a point response that reports an alarm, whether or not the point is armed. For instance, P## Type 1 and P## Response 9 reports an alarm on an open or a short (I) whether the area is armed or not.

Local While Disarmed affects Keyswitch points. This prompt suppresses keyswitch (troubles and restorals) and D279 (alarms, troubles, and restorals). Do not use this parameter for these applications.

P## Local While Armed

Default:	No
Selection:	Yes or No
Yes	Suppress Alarm, Trouble and Restoral* Reports from this point while the area to which it is assigned is armed.
No	Report events occurring from this point while the area is armed.

* Transmission of Restoral Reports continues if the alarm, trouble, or bypass (by Sked, RPS, or Swinger bypass) condition occurred when the area disarmed, and the point restored.

Allows a controlled point (P## Type 1, 2, 3), to report Alarms, Troubles, and Restoral Reports only when the area is disarmed. This prompt does not affect local annunciation.



Local While Armed suppresses all reports from 24-hour points. Do not use P## Type 0 for this prompt. This setting works only for disarmed points. Type 0 is a 24-hour, always armed point. Choose any Type other than 0, and use a point response that reports an alarm whether or not the point is armed. For instance, P## Type 1 and P## Response 9 reports an alarm on a trouble or a short whether or not the area is disarmed.

Local While Armed affects Keyswitch Points. This prompt suppresses keyswitch (alarms, troubles, and restorals) and D279 (opening, closing, troubles, and restorals). Do not use this parameter for controlled points that arm or disarm.

P## Disable Rst

Default:	No
Selection:	Yes or No
Yes	Enable Restoral Reports from this point.
No	Disable Restoral Reports from this point.

* Transmission of Restoral Reports continues if the alarm, trouble, or bypass (by Sked, RPS, or Swinger bypass) condition occurred when the area disarmed, and the point restored.

Use this option to disable any Restoral Reports from this point after it returns to normal from an alarm or trouble condition.

P## FA Retrnable

Default:	No
Selection:	Yes or No
Yes	This point automatically returns to the system when it restores to normal.
No	This point stays out of the system until the area is disarmed.

Use this option to allow points that were force armed out of the area to return back to the armed state when they become normal again without having to disarm the system.



Use on loading dock doors, that must remain open until loading is completed. After the loading dock door is closed, the point detects any subsequent opening and reports an alarm.

P## BP Retrnable

Default:	No
Selection:	Yes or No
Yes	This point automatically returns to the system when the area is disarmed.
No	This point stays out of the system through arming and disarming cycles.

Use this option to return a point that was bypassed, force armed, or swinger bypassed back into the system when the area to which this point is assigned is disarmed



Set this item to **No** for Interlock points.



When the point cannot return to the system through disarming, the point must be manually unbypassed using the Unbypass?, keypad function, Sked Functions 4 and 5, or remote programming software (RPS).



For Force Armed points to remain bypassed, ensure that **P## FA Retrnable** is set to **No**.

P## Bypassable

Default: No	
Selection: Yes or No	
Yes	This point can be bypassed and force armed.
No	This point cannot be bypassed or force armed from the keypad or remote programming software (RPS); however, it can be force armed by automatic arming at the end of the Closing Window (refer to the A# Auto Close prompt in <i>Section 2.9.5 Open/Close Options</i> on page 39 or by a Sked programmed to arm the area.

Use this option to allow this point to be bypassed or force armed.

Bypassing a 24-hour point: When a 24-hour point or 24-hour Supervisory point is bypassed, 24 HOUR BYPASS scrolls continuously at the keypad. 24 HOUR BYPASS scrolls to indicate that a 24-hour Non-fire point, **P## Fire No**, is bypassed. FIRE BYPASS scrolls to indicate that a 24-hour Fire point or a Fire Supervisory point is bypassed.

 **Alternative to a 24-hour Point:** For alarm capability of a 24-hour point without the continuous scrolling, use a Perimeter point with a Point Response of 9 to E.



 **If the P## Bypassable option is set to Yes,** a point can be bypassed in several ways. Refer to *Table 29*.

Table 29: Bypassing a Point	
Bypass with:	Report sent:
Keypad using the Bypass? function	Command Bypass
Keypad using Command 0	Command Bypass
Sked Function 3	Sked Bypass
Remote programming software (RPS)	RPS Bypass*
* RPS Bypass is sent at the end of the RPS session.	

 **If the P## Swinger Bypas option is set to Yes,** a point is automatically bypassed after the fourth alarm or trouble report is sent. A swinger Bypass report is sent at the same time.

 Programming **Bypassable** as **Yes** for Cross points can cause missed Cross-Point alarms. For example, if Points 1 and 2 were programmed as Cross points and Point 1 was Bypassed or Force Armed, Point 2 cannot generate an Alarm Cross Point Event. Point 2 can; however, generate an Unverified or Alarm Event depending on how the point was faulted. Be careful when using this feature with Cross point applications.

P## Swinger Bypas

Default: No	
Selection: Yes or No	
Yes	Enable Swinger Bypass for this point.
No	Disable Swinger Bypass for this point.

Use this option to allow the control panel to bypass automatically a point that erroneously reports four alarm or trouble events within an hour of the first event.

The control panel reports a Swinger Bypass P### upon the fourth report. If the point has a partial count (less than four events during an hour), the count is reset to zero and three more events are needed by the next report before the control panel initiates the bypass.

 **P## Bypassable** does not need to be programmed as **Yes** for swinger bypass to work.

 A Swinger Shunted point returns to the system if **P## BP Returnable?** is **Yes**. If not, return the point to the system through manual unbypass or [COMMAND][0][0]. Refer to **P## BP Retrnable** on page 91 for additional information.

P## Report Bypass at Occurrence

Default: No	
Selection: Yes or No	
Yes	Send a Command Bypass Report when the point is bypassed.
No	Do not send a Command Bypass Report when the point is bypassed.

Send a Command Bypass Report as soon as a user bypasses the point from the keypad. Enable this option for all Bypassable 24-hour points. You can also report a bypassed point at the time the area is armed. Refer to **P## Defer BP Report** on page 93.

P## Defer BP Report

Default:	No
Selection:	Yes or No
Yes	Send a Point Bypass Report with the Closing Report instead of a Command Bypass Report when a user bypasses the point.
No	Do not defer Bypass Reports.

Use this option to prevent **P## Type** (0 to F) points that are bypassed by the user (COMMAND BYPASS) from occurring until the area is armed. When the area is armed, the bypassed points and any point being bypassed during the arming sequence report as POINT BYPASS along with the Closing Report.



When **P## Defer BP Report** is set to **Yes** and Closing Reports are suppressed by using **Closing Windows**, the deferred Bypass Reports are not sent.

Bypass Reports for 24-hour points do not report if **P## Report Bypass at Occurrence** and **P## Defer Bypass Report** are both set to **No**.



To report the bypass at occurrence and when the area is armed, program **P## Report Bypass at Occurrence** and **P## Defer Bypass Report** as **Yes**. A Command Bypass Report is sent as soon as the user manually bypasses a point, and a supplemental Point Bypass Report is sent with the Closing Report.

P## Cross Point

Default:	No
Selection:	Yes or No
Yes	This point is a Cross point.
No	This point is not a Cross point.



Do not use Cross points for Fire points.

The Cross point feature is available only on points programmed with an Instant point response. Also, Controlled points (Point Types 1, 2 and 3) do not follow the Cross point operation, described as follows, during entry or exit delay.

The Cross point option is designed to reduce false alarms. To achieve this, program two or more points within a Cross Point Group. A Cross Point Group generates a Cross Point Alarm event when all points in the group are faulted within the Cross Point Time. These points need the Cross point option enabled in their corresponding point indexes to generate this event. Refer to *Section 6.9 Cross Point Parameters* on page 132 for additional programming requirements to program the Cross Point Timer.

Cross Point Groups were established in the D9412GV2 and D7412GV2 to support the Cross Point function. There are 31 Cross Point Groups in the D9412GV2 and ten in the D7412GV2. Each Cross Point Group consists of eight points and is identified by the point numbers in them (such as, Cross Points 1 to 8, Cross Points 9 to 16, and so on).



The Cross point function only applies to Alarm conditions. It does not apply to Trouble or Supervisory conditions.

P## Fire Point

Default:	No
Selection:	Yes or No
Yes	This point is a Fire point.
No	This point is not a Fire point.

Use this option to make a 24-hour point a Fire point. This option makes this point the highest priority event in the control panel when an alarm occurs for both reporting and displaying on the keypad. Refer to *Section 4.2.2 Characteristics of a Fire Point* on page 85.



You should dedicate a fire annunciation device to all your Fire points if they are assigned to a single area in a multiple area system. Special red keypads and annunciators with specific keys for fire systems are designed for this type of application (D1256 and D1257).



Do not use the Cross point function for Fire points.

P### Alarm Verify

Default:	Refer to the program record sheet
Selection:	Yes or No
Yes	Enable alarm verification on this point. Alarm verification points must be programmed as resettable.
No	Disable alarm verification on this point.

Use this option only with Fire points to designate them for alarm verification.

When an Alarm Verification point enters into alarm, the control panel removes power to all Resettable points for the duration programmed in **A# Verify Time** in *Section 2.9 Area Parameters* on page 32. If the point (or another Resettable point in the area) is still faulted, or returns to a faulted state within 60 seconds after the initial verification time reset, an alarm is generated.

	During a Fire Walk Test the reset time is 5 seconds. The time programmed in A# Verify Time is ignored. Use the Cross point function for Fire points.
---	---

P### Resettable

Default:	Refer to the program record sheet
Selection:	Yes or No
Yes	This point is reset by the Reset Sensor? function and during the alarm verification sequence.
No	This point is not resettable.

Use this option if this is a Powered point that requires interruption of power to reset a latched alarm condition. The Resettable point option is typically used with smoke detectors and glass break detectors.

When initiated (either through a Fire Walk Test or the keypad's Reset Sensor? function) or when the remote programming software (RPS) interrupts power to the device for 5 seconds, a Sensor Reset report is sent to the central station receiver.

	When a sensor reset occurs, the control panel does not accept alarms from any points with P### Resettable programmed as Yes . During the 5-second reset time, alarms from these points are ignored. Do not mix fire and intrusion devices on the same powered loop.
---	--



4.3 Point Assignments

These entries assign point indexes to Points 1 to 127, 129 to 247 for the D9412GV2 and Points 1 to 75 for the D7412GV2, and assign the points to the areas. Also included in this section are parameters used to set the point's debounce count, BFSK/Relay (for use when transmitting in BFSK or assigning relays to follow alarms for a group of points), and custom keypad and report text for each point.

Point Number

Default:	1
Selection:	1 to 127, 129 to 247

Enter the point number you are programming. When transmitting in Modem IIIa², the three-digit point number is reported to the D6500 or D6600. When transmitting in BFSK, you must assign a zone number in BFSK/Relay.

	Point number 128 is reserved for supervising Zonex 1.
	Point number 248 is reserved for supervising Zonex 2.

P### Point Index**Default:** Refer to the program record sheet**Selection:** Blank (00) to 31

This entry selects one of the 31 **P### Index** codes that define the point's characteristics and determines how the control panel responds to various point conditions. Blank (00) disables the point.

Missing Point Report

If a Point Index is assigned to a point that has an incorrect address or that is not connected to the point bus, a Missing Point Report occurs.

When a POPIT is missing, the control panel generates the following responses based on the point type:

- Fire points generate missing trouble responses.
- Non-fire 24-hour points generate missing alarm responses.
- Non-fire, non 24-hour points generate missing alarm responses while armed, and trouble responses while disarmed. Exception: Non-fire, non-24-hour points with a point response of 9 to D generate a missing alarm response while disarmed.

POPIT modules monitor their sensor loops for three conditions: loop normal, loop open, and loop shorted. They send reports on these three conditions to the control panel. The control panel uses point programming to interpret the sensor loop information sent by the POPITs and to make the appropriate system response.

P### Area Assign**Default:** 1**Selection:** 1 to 8

The areas are numbered 1 to 8. Select the area number to which the point is assigned.

P### Debounce**Default:** 2**Selection:** 1 to 15

1	.300 seconds
2	.600 seconds
3	.900 seconds
4	1.2 seconds
5	1.5 seconds
6	1.8 seconds
7	2.1 seconds
8	2.4 seconds
9	2.7 seconds
10	3.0 seconds
11	3.3 seconds
12	3.6 seconds
13	3.9 seconds
14	4.2 seconds
15	4.5 seconds

The debounce count is the number of times the control panel scans a point before generating an alarm. Scan cycles are 300 ms.

For appropriate settings consult the manufacturer's instructions for the device connected to this point.



Use an entry of two or higher. Interior Follower points need a Debounce value of at least three.



Door points assigned to D9210B modules need a Debounce value of at least four.

P### BFSK/Relay

Default: Refer to the program record sheet
Selection: 0 to 9

Use this option to:

- Determine the point number sent in BFSK format when this point is faulted.
- Activate a relay when the point is faulted, even if the control panel is programmed for Modem IIIa² reporting format. Refer to *Table 30*.



BFSK/Relays do not activate for Fire Supervisory or Non-Fire Supervisory points.

Table 30: P### BFSK/Relay Codes/Relays

BFSK Code	Faults Relay	
	D8129 on Zonex Bus 2 for D9412GV2*	D8129 on Zonex Bus 1 for D7412GV2*
1	73	9
2	74	10
3	75	11
4	76	12
5	77	13
6	78	14
7	79	15
8	80	16

* Address setting = 1 (on), 2 (off), 3 (on), 4 (on)



Local annunciation on the keypads, Local Printer reports, and the View Log show the actual point number (1 to 247), not the BFSK report code



Do not assign a BFSK or relay to Invisible points. To avoid activating one of the associated relays, program this prompt as 0.

On the D9412GV2, do not use Relays 73 through 80 for Area or Panel-Wide Relay function when this prompt is enabled for the corresponding points. Refer to *Table 30*.

On the D7412GV2, do not use Relays 9 through 16 for Area or Panel-Wide Relay function when this prompt is enabled for the corresponding points. Refer to *Table 30*.



Two relays can activate when this point enters into alarm if the **P### Rly Resp Type** for this point is programmed.

Use these codes to activate relays on the D8129 OctoRelay (or C8137 Transmitter Interface). You can assign the same code to several points providing a summary zone alarm output. When the point enters into alarm, the relay activates. When the alarm is acknowledged and is no longer scrolling in the keypad display, the relay resets.

P### Point Text

Default: Refer to the program record sheet
Selection: Up to sixteen alphanumeric characters

Enter alphabetic characters (A to Z) in capital letters.

Enter up to sixteen characters of text to describe the point. This point text is shown at keypads, if the point is programmed as visible, and sent to the D6500 or D6600 when transmitting in Modem IIIa² format (if it is a reporting point).

Include the point number in custom point text. This helps the user when viewing events, creating bypasses, and so on. It can also simplify troubleshooting.



When a D1260 Keypad is installed on the system, the point text for Points 240 to 247 can be used for Area Name Text for Areas 1 to 8, respectively. Refer to *Table 31*:

Table 31: Point Text for Points 240 to 247

Point Text	Corresponding Area Name Text
Point 240	Area 1
Point 241	Area 2
Point 242	Area 3
Point 243	Area 4
Point 244	Area 5
Point 245	Area 6
Point 246	Area 7
Point 247	Area 8

4.4 COMMAND 7 and COMMAND 9

These entries assign point indexes, BFSK report code, BFSK relay that activates, and the text for the COMMAND 7 and COMMAND 9 keypad functions.

CMD7 Point Index

Default: 31

Selection: Blank (00) to 31

This entry selects one of the 31 **P## Index** codes that define how the control panel reacts when a COMMAND 7 is initiated.



The point index code used for COMMAND 7 must not be used for any other points on the system.



If the point index for COMMAND 7 has Fire points programmed as **Yes**, this causes access control doors to unlock if Fire Unlock is also programmed as **Yes**. Refer to the *D9210B Program Entry Guide* (P/N: 32206).

CMD7 BFSK/Relay

Default: 1

Selection: 0 to 9

This entry selects one of the digits shown for reporting in BFSK or for activating relays 73 to 80 (on the D9412GV2) or relays 9 to 16 (for the D7412GV2) when COMMAND 7 is initiated (refer to the **P### BFSK/Relay** prompt in *Section 4.3 Point Assignments* on page 94).



COMMAND 7 does not activate the Summary Fire Alarm relay.

CMD7 Point Text

Default: [COMMAND][7]

Selection: Up to sixteen alphanumeric characters

Enter alphabetic characters A to Z in capital letters

Enter up to sixteen characters of text to describe the point. This point text appears at keypads (if the point is programmed as visible) and sent to the D6500 or D6600 when transmitting in Modem IIIa² format (if it is a reporting point).

CMD9 Point Index

Default: 31

Selection: Blank (00) to 31

This entry selects one of the 31 **P## Index** codes that define how the control panel reacts when a COMMAND 9 is initiated.



The point index code used for COMMAND 9 must not be used for any other points on the system.



If the point index for COMMAND 9 has Fire points programmed as **Yes**, this causes access control doors to unlock if Fire Unlock is also programmed as **Yes**. Refer to the *D9210B Program Entry Guide* (P/N: 32206).

CMD9 BFSK/Relay

Default: 1

Selection: 0 to 9

The value in this entry selects one of the digits shown for reporting in BFSK or for activating relays 73 to 80 (on the D9412GV2) or relays 9 to 16 (for the D7412GV2) when a COMMAND 9 is initiated (refer to the **P### BFSK/Relay** prompt in *Section 4.3 Point Assignments* on page 94).



COMMAND 9 does not activate the Summary Fire Alarm relay.

CMD9 Point Text

Default: [COMMAND][9]

Selection: Up to sixteen alphanumeric characters

Enter alphabetic characters (A to Z) in capital letters

Enter up to sixteen characters of text to describe the point. This point text is displayed at keypads (if the point is programmed as visible) and sent to the D6500/D6600 when transmitting in Modem IIIa² format (if it is a reporting point).

Notes

5.0 RADXSKED

5.1 Windows

Use this programming module to define the windows for Opening and Closing and User Access.

5.1.1 Opening and Closing

Use these windows to set a schedule for disarming and arming. The disarming and arming schedules have several independent features:

- Suppress normal Opening or Closing Reports when **A# Disable O/C in Windows** is programmed as **Yes**.
- Generate a Fail to Open Report if the area is not disarmed on schedule when **A# Fail To Open** is programmed as **Yes**.
- Provide a warning tone and a PLEASE CLOSE NOW display at the keypad when it is time to arm the area.
- Generate a Fail to Close Report if the area is not armed on schedule when **A# Fail To Close** is programmed as **Yes**.
- Automatically arm the area at the end of the Closing Window when **A# Auto Close** is programmed as **Yes**.

Opening and closing schedules can be set up independently. For example, if you want to use features provided only by Closing Windows, leave times blank in the Opening Windows prompts and program Closing Window times.

A worksheet is provided at the end of this section for your convenience. Following the worksheet are examples of programming Opening and Closing Windows for particular applications (refer to *Table 36* on page 105 through *Table 40* on page 106).

About the program record sheet: A column labeled Sked # is found in the program record sheet provided with the control panel. The numbers in that column appear in D6500 and D6600 reports and local printer reports when the window Begin Time executes.

Window selections 1 through 8 correspond with odd-numbered Skeds 41 through 55 for Open Window and correspond with even numbered Skeds 42 through 56 for Close Window. For example, when the Opening Window for Window 1 executes, a Sked 41 Executed event is generated. Refer to *Table 32*.

Table 32: Window Selections

Selection	Sked #	Window	Sked #	Window
1	41	Open	42	Close
2	43	Open	44	Close
3	45	Open	46	Close
4	47	Open	48	Close
5	49	Open	50	Close
6	51	Open	52	Close
7	53	Open	54	Close
8	55	Open	56	Close

Window

Default: 1
Selection: 1 to 8

Enter the window number you want to program.

W# Sunday

Default: No
Selection: Yes or No

Yes	Activate this window on Sundays.
No	Do not activate this window on Sundays.

This prompt and the next six day-of-the-week prompts select the days of the week the Opening and Closing windows are active.

Exceptions:

To prevent the windows from activating on certain days of the year, program **Xept Holiday** as **Yes**, and enable at least one Holiday Index. When **Xept Holiday** is **Yes**, the window executes on the days of the week programmed unless the Holiday Index designates the date as a holiday.

If Opening and Closing Windows are only needed on certain days of the year, do not program the windows to execute on any days of the week. Instead, program **Xept Holiday** as **No** and select a Holiday Index with the days of the year you want the window to be active.

W# Monday

Default: No
Selection: Yes or No

W# Tuesday

Default: No
Selection: Yes or No

W# Wednesday

Default: No
Selection: Yes or No

W# Thursday

Default: No
Selection: Yes or No

W# Friday

Default: No
Selection: Yes or No

W# Saturday

Default: No
Selection: Yes or No

W# Open Early Begin

Default: 00:00
Selection: HH:MM (hours and minutes)
 00:00 to 23:59

Open Early Begin: This program item is one of three required to create an Opening Window. To finish programming an Opening Window, Open Window Start and Open Window Stop must be programmed.

The time programmed in the **W# Open Early Begin** field is the earliest time that the user is allowed to open an area before the Opening Window Start time. If Opening and Closing Reports are enabled, disarming the area between midnight and the open Early Begin time generates an Opening Report.

- If **A# Disable O/C in Window** is set to **Yes** and the area is disarmed between the Open Early Begin time and the Open Window Start time, the Opening event is sent with an Early to Open modifier. If the Open Early Begin time is the same as the Open Window Start time, no Opening Event is sent.

- If **Disable O/C in Window** is set to **No** and the area is disarmed at any time, an Opening Event is sent without an Early to Open or Late to Open modifier.

Disarming the area between the Open Window Start and open Window Stop times creates a local event in the control panel event log, but does not send the Opening Report to the central station.

Disarming the area between the Open Window Stop time and before the next window's Open Early Begin time (or midnight, whichever is earlier) generates an Opening Event with a Late to Open modifier.

When configuring multiple windows to operate on the same day, ensure that they are added to the system in chronological order. For example, if three windows are programmed to execute on Tuesday, Window 1 (W1) must occur before Window 2 (W2), and Window 2 must occur before Window 3 (W3).



Avoid programming the Open Early Begin time before a time that is between another window's Open Window Start and Open Window Stop times.



Do **not** program a window to cross the midnight boundary.

Disabled windows have a blank beginning time. If the entry for this prompt is blank, but times are programmed for Open Window Start and Open Window Stop, the window is disabled.

To disable the window, all hours and minutes spaces must be blank.



Make time entries using a 24-hour clock. For example:

Midnight is entered as 00:00
 7:00 AM is entered as 07:00
 2:45 PM is entered as 14:45
 11:59 PM is entered as 23:59

Reboot the control panel to activate today's window, if the window needs to activate on the same day you program it.

W# Open Window Start

Default: 00: 00

Selection: HH:MM (hours and minutes)

Enter the time you want the control panel to start the Opening Window. The window goes into effect at the beginning of the minute.

Make time entries using a 24-hour clock. For example:

Midnight is entered as 00:00
 7:00 AM is entered as 07:00
 2:45 PM is entered as 14:45
 11:59 PM is entered as 23:59

This program item is one of three required to create an Opening Window. To program an Opening Window, Open Early Begin and Open Window Stop must also be programmed. Refer to the **W# Open Early Begin** prompt on page 100 for explanations of report features.

W# Open Window Stop

Default: 00: 00

Selection: HH:MM (hours and minutes)

Enter the time you want the control panel to end the Opening Window. The window stops at the end of the minute.

Make time entries using a 24-hour clock. For example:

Midnight is entered as 00:00
 7:00 AM is entered as 07:00
 2:45 PM is entered as 14:45
 11:59 PM is entered as 23:59

This program item is one of three required to create an Opening Window. To program an Opening Window, Open Early Begin and Open Window Start must also be programmed.

If the area is not disarmed by the time the Open Window Stop time expires, the control panel generates a Fail to Open Report if **A# Fail to Open** is enabled in Area-Wide Parameters.

Opening Reports generated between the Open Window Start time and Open Window Stop time can be suppressed by programming **A# Disable O/C in Window** as **Yes**. Refer to the **W# Open Early Begin** prompt on page 100 for additional explanations of report features.

Do not use a time of 23:59 as a window stop time unless another window begins on the next day at 00:00.

Fail to Open Reports are not sent for windows that stop at 23:59.

Figure 5: Example Opening Window Timeline (using two Opening Windows on same day)

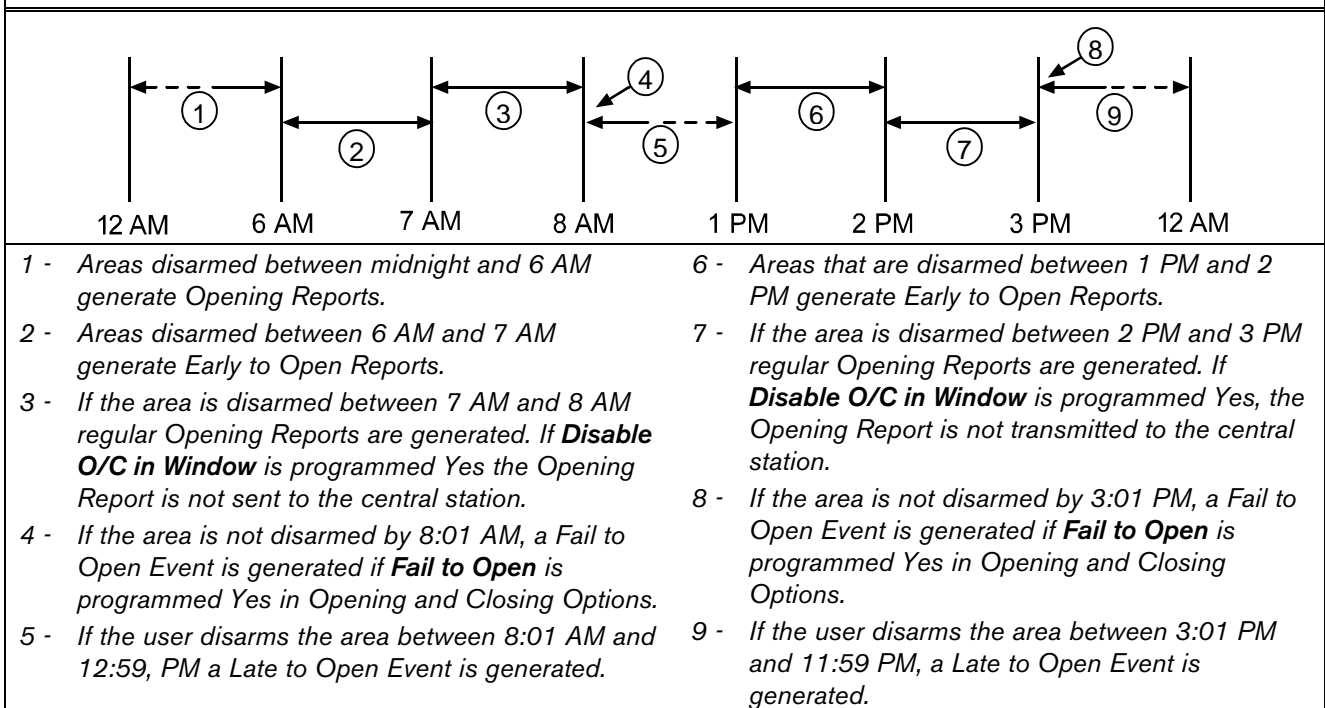

Table 33: Programming for Two Same Day Opening Windows (refer to Figure 5)

W#	Day of Week	Open			Close			eXcept On Holiday	Holiday Index	Area(s)
		Early Begin	Start	Stop	Early Begin	Start	Stop			
1	S <u>M</u> T W T F S	06:00	07:00	08:00				Yes / <u>No</u>	1 2 3 4	<u>1</u> 2 3 4 5 6 7 8
2	S <u>M</u> T W T F S	13:00	14:00	15:00				Yes / <u>No</u>	1 2 3 4	<u>1</u> 2 3 4 5 6 7 8

Do not program a single window to cross the midnight boundary. The window stop time must be later than the window start time. To program a window that effectively crosses the midnight boundary, you must program two windows.

For example, to program windows for an area that opens between 11:30 PM and 12:30 AM, five days a week, use two windows as shown in *Table 34*.

Table 34: Programming to Link Two Days over Midnight*

W#	Day of Week	Open			Close			eXcept On Holiday	Holiday Index	Area(s)
		Early Begin	Start	Stop	Early Begin	Start	Stop			
1	S <u>M</u> T W T F S	22:00	23:30	23:59				Yes <u>No</u>	1 2 3 4	<u>1</u> 2 3 4 5 6 7 8
2	S <u>M</u> T W T F S	00:00	00:00	00:30				Yes <u>No</u>	1 2 3 4	<u>1</u> 2 3 4 5 6 7 8

* The setting for midnight is 00:00.

W# Close Early Begin

Default: 00:00
Selection: HH:MM (hours and minutes)
 00:00 to 23:59

Close Early Begin: This program item is one of three required to create a Closing Window. To finish programming a Closing Window, Close Window Start and Close Window Stop must be programmed.

The time programmed in the Close Early Begin field is the earliest time the user can close an area before the Closing Window Start time. If Opening and Closing Reports are enabled, arming the area between midnight and the Close Early Begin time generates a Closing Report. Additionally:

- If *A# Disable O/C in Window* is set to **Yes** and the area is armed between the Close Early Begin time and the Close Window Start time, the Closing Event is sent with an Early to Close modifier. If the Close Early Begin time is the same as the Close Window Start time, no Closing Event is sent.
- If *A# Disable O/C in Window* is set to **No** and the area is armed at any time, a Closing Event is sent without the Early to Close or late to Close modifiers.

Arming the area between the Close Window Start and Close Window Stop times creates a local event in the control panel event log, but does not send the Closing Report to the central station.

Arming the area after the Close Window Stop time and before the next window's Close Early Begin time (or midnight, whichever is earlier) generates a Closing Event with a Late to Close modifier.

When configuring multiple windows to operate on the same day, ensure that they are added to the system in chronological order. For example, if three windows are programmed to execute on Tuesday, Window 1 (W1) must occur before Window 2 (W2), and Window 2 must occur before Window 3 (W3).



Avoid programming the Open Early Begin time before a time that is between another window's Open Window Start and Open Window Stop times.

Disabled windows have a blank beginning time. If the entry for this prompt is blank, but times are programmed for Close Window Start and Close Window Stop, the window is disabled.

To disable the window, both the hours and minutes spaces must be blank.

00:00 is midnight, 23:59 is 11:59 PM. Make entries using a 24-hour clock (for example, 7:00 AM is entered as 07:00, 2:45 PM is entered as 14:45).

Reboot the control panel to activate today's window. The window needs to activate on the same day you program it.

W# Close Window Start

Default: 00:00
Selection: HH:MM (hours and minutes)

Enter the time that you want the control panel to start the Closing Window. The window goes into effect at the beginning of the minute.

00:00 is midnight, 23:59 is 11:59 PM. Make entries using a 24-hour clock (for example, 7:00 AM is entered as 07:00, 2:45 PM is entered as 14:45).

This program item is one of three required to create a Closing Window. To program a Closing Window, Close Early Begin and Close Window Stop must also be programmed.

If the area is not armed when the Close Window Start time comes, a warning tone sounds and PLEASE CLOSE NOW appears at the keypad. To temporarily silence the tone, press the [ESC] key on the keypad. The warning tone restarts in 10 minutes if the area is not armed.

Refer to the **W# Close Early Begin** prompt in this section for explanations of report features.

W# Close Window Stop

Default: 00:00
Selection: HH:MM (hours and minutes)

Enter the time that you want the control panel to end the Closing Window. The window stops at the end of the minute.

00:00 is midnight, 23:59 is 11:59 PM. Make entries using a 24-hour clock (for example, 7:00 AM is entered as 07:00, 2:45 PM is entered as 14:45).

This program item is one of three required to create a Closing Window. To program a Closing Window, Close Early Begin and Close Window Start must also be programmed.

If the area is not armed by the time the Close Window Stop time expires, the control panel generates a Fail to Close Report if enabled in Fail To Close.

Closing Reports generated between the Close Window Start time and Close Window Stop time can be suppressed by programming **Disable O/C in Window** as **Yes**. Refer to the **W# Close Early Begin** prompt for other explanations of report features.

Do not use a time of 23:59 as a window stop time unless the window continues on the next day at 00:00. Fail to Close Reports are not sent, and the Auto Close feature does not work for windows that stop at 23:59.

Do not program a single window to cross the midnight boundary. The window stop time must be later than the window start time. To program a window that effectively crosses the midnight boundary, you must program two windows.

For example, to program windows for an area that closes between 11:30 PM and 12:30 AM, five days a week, use two windows as shown in *Table 35*.

Table 35: W# Close Window Stop Programming Example

W#	Day of Week	Open			Close			eXcept On Holiday	Holiday Index	Area(s)
		Early Begin	Start	Stop	Early Begin	Start	Stop			
1	S M T W T F S				22:00	23:30	23:59	Yes <u>No</u>	1 2 3 4	<u>1</u> 2 3 4 5 6 7 8
2	S M T W T F S				00:00	00:00	00:30	Yes <u>No</u>	1 2 3 4	<u>1</u> 2 3 4 5 6 7 8

W# Xept Holiday

Default: No	
Selection: Yes or No	
Yes	Do not activate this window on holidays. To use this selection, the window must be programmed to activate on at least one day of the week and a Holiday Index must be enabled.
No	A holiday does not prevent this window from activating. You also use this selection if Opening or Closing Windows are needed only on certain days of the year. Do not program the windows to execute on any days of the week. Instead, program Xept Holiday as No , and select at least one Holiday Index with the days of the year you want the window to be active.

Determine if the window is disabled on holidays, or is active only on holidays.

To prevent the windows from activating on certain days of the year, program **Xept Holiday** as **Yes**, and enable at least one Holiday Index. When **Xept Holiday** is programmed as **Yes**, the window executes on the days of the week programmed unless the date is designated as a Holiday by the Holiday Index(es) selected.

Holiday Indexes for O/C Windows

You can enable up to four Holiday Indexes for use with Opening/Closing Windows. Enable at least one Holiday Index if **W# Xept Holiday** is programmed as **Yes** for this window, or if you want this window to activate only on specific dates. Holidays are programmed in *Section 5.3 Holiday Indexes* on page 117.

W# Holiday 1

Default: No	
Selection: Yes or No	
Yes	Use Holiday Index 1 with this window.
No	Do not use Holiday Index 1 with this window.

W# Holiday 2

Default: No	
Selection: Yes or No	
Yes	Use Holiday Index 2 with this window.
No	Do not use Holiday Index 2 with this window.

W# Holiday 3

Default: No	
Selection: Yes or No	
Yes	Use Holiday Index 3 with this window.
No	Do not use Holiday Index 3 with this window.

W# Holiday 4

Default: No	
Selection: Yes or No	
Yes	Use Holiday Index 4 with this window.
No	Do not use Holiday Index 4 with this window.

W# Area 1 [through 8]

Default: No	
Selection: Yes or No	
Yes	Activate the window in the area number (#) specified.
No	Disable the window in the area number (#) specified.

Eight separate program items determine whether a particular window activates in each of the eight areas of the control panel.

Table 36: Opening and Closing Windows Worksheet

W#	Day of Week	Open			Close			eXcept On Holiday	Holiday Index	Area(s)
		Early Begin	Start	Stop	Early Begin	Start	Stop			
1	S M T W T F S	__ : __	__ : __	__ : __	__ : __	__ : __	__ : __	Yes No	1 2 3 4	<u>1</u> 2 3 4 5 6 7 8
2	S M T W T F S	__ : __	__ : __	__ : __	__ : __	__ : __	__ : __	Yes No	1 2 3 4	<u>1</u> 2 3 4 5 6 7 8
3	S M T W T F S	__ : __	__ : __	__ : __	__ : __	__ : __	__ : __	Yes No	1 2 3 4	<u>1</u> 2 3 4 5 6 7 8
4	S M T W T F S	__ : __	__ : __	__ : __	__ : __	__ : __	__ : __	Yes No	1 2 3 4	<u>1</u> 2 3 4 5 6 7 8
5	S M T W T F S	__ : __	__ : __	__ : __	__ : __	__ : __	__ : __	Yes No	1 2 3 4	<u>1</u> 2 3 4 5 6 7 8
6	S M T W T F S	__ : __	__ : __	__ : __	__ : __	__ : __	__ : __	Yes No	1 2 3 4	<u>1</u> 2 3 4 5 6 7 8
7	S M T W T F S	__ : __	__ : __	__ : __	__ : __	__ : __	__ : __	Yes No	1 2 3 4	<u>1</u> 2 3 4 5 6 7 8
8	S M T W T F S	__ : __	__ : __	__ : __	__ : __	__ : __	__ : __	Yes No	1 2 3 4	<u>1</u> 2 3 4 5 6 7 8

Table 37: Opening and Closing Windows

Day of Week	The column below briefly describes how to activate an Opening–Closing Window. Use the guidelines shown in the other columns to choose the appropriate entries.	eXcept On Holiday	Holiday Index	Areas
Program at least one day Yes.	Day(s) of the week	No	None	Program at least one area Yes .
Program at least one day Yes.	Day(s) of the week, but not on holidays	Yes	Select at least one Index	Program at least one area Yes .
Program at least one day Yes.	Day(s) of the Week, plus holidays	No	Select at least one Index	Program at least one area Yes .
All days must be programmed No .	Only on holidays	No	Select at least one Index	Program at least one area Yes .

Table 38: Normal Store Hours*

W#	Day of Week	Open			Close			eXcept On Holiday	Holiday Index	Area(s)
		Early Begin	Start	Stop	Early Begin	Start	Stop			
1	S <u>M</u> T W T F S	04:00	05:00	06:00	20:00	23:00	23:59	Yes No	1 2 3 4	<u>1</u> 2 3 4 5 6 7 8
2	S M <u>T</u> W T F S	__ : __	__ : __	__ : __	00:00	00:00	01:00	Yes No	1 2 3 4	<u>1</u> 2 3 4 5 6 7 8

* Monday to Friday, Opening between 5 AM and 6 AM. Closing between 11 PM and 1 AM.

Table 39: Delivery Schedule*

W#	Day of Week	Open			Close			eXcept On Holiday	Holiday Index	Area(s)
		Early Begin	Start	Stop	Early Begin	Start	Stop			
3	S <u>M</u> T <u>W</u> T F S	02 : 30	02 : 45	03 : 00	03 : 05	03: 15	03: 30	<u>Yes</u> No	<u>1</u> 2 3 4	<u>1</u> 2 3 4 5 6 7 8
						00 : 00	01 : 00	Yes <u>No</u>	1 2 3 4	<u>1</u> 2 3 4 5 6 7 8
	Program at least one day Yes .	Day(s) of the week, but not on holidays						Yes	Select at least one index	Program at least one area Yes .

* Monday and Wednesday, In between 2:45 AM and 3:00 AM. Out between 3:15 AM and 3:30 AM. Another alternative for delivery schedules is to automatically bypass specific points using skeds.

Table 40: Monthly Auditor's Schedule*

W#	Day of Week	Open			Close			eXcept On Holiday	Holiday Index	Area(s)
		Early Begin	Start	Stop	Early Begin	Start	Stop			
4	S M T W T F S	07 : 00	08 : 00	08 : 30	14 : 00	14: 30	17: 00	Yes <u>No</u>	1 <u>2</u> 3 4	<u>1</u> 2 3 4 5 6 7 8
	All days must be programmed No .	Only on holidays						No	Select at least one index	Program at least one area Yes .

* Sunday, In between 8:00 AM and 8:30 AM. Out between 2:30 PM and 5:00 PM..

5.1.2 User Group Windows

In this section, you can create up to eight User Group periods where the pass codes for the group chosen is enabled. One user group can have multiple windows assigned to it over a 24-hour period. Refer to the **U### User Group** prompt in *Section 3.1 Pass Code* or Token Worksheet to assign individuals to a group.

When you assign a **U### User Group** to one of the eight windows, all pass codes for the group are enabled **ONLY** for the period between the Enable Time and Disable Time for assigned **User Windows #**.

If a user is not assigned to a **U### User Group** or the number programmed for the user for **U### User Group** is not assigned to a **User Windows #**, the pass code for that user is enabled all the time.

User Group Windows **do not** affect the users token or card access authority. To enable/disable tokens, the Sked Function Access Levels On/Off must be used.

User Windows #

Default: 1
Selection: 1 to 8

Enter the User Windows number you want to program.

UW# User Group

Default: 1
Selection: Blank, 1 to 8

Enter the number programmed for the group of users in the **U### User Group** prompt. This group has its user pass codes enabled or disabled when this window runs.

A User Group can be assigned to more than one window in a 24-hour period, but the windows must not overlap or exceed the midnight boundary.

UW# Sunday

Default: No
Selection: Yes or No

This prompt, and the next six day of the week prompts, select the days of the week that the User Group Window is active.



Refer to the **W# Sunday** prompt in *Section 5.1.1 Opening and Closing* on page 99 for more information about programming this prompt.

UW# Monday

Default: No
Selection: Yes or No

UW# Tuesday

Default: No
Selection: Yes or No

UW# Wednesday

Default: No
Selection: Yes or No

UW# Thursday

Default: No
Selection: Yes or No

UW# Friday

Default: No
Selection: Yes or No

UW# Saturday

Default: No
Selection: Yes or No

UW# Group Enable

Default: 00:00
Selection: HH:MM (hours and minutes)



This prompt must be programmed if this User Group Window is assigned to a user group.

Enter the time of day when the window starts. Beginning at this time, users assigned to this window's group can use their pass codes. The window goes into effect at the beginning of the minute. Make entries using a 24-hour clock (for example, 7:00 AM is entered as 07:00, 2:45 PM is entered as 14:45).

Reboot the control panel to activate today's window. The window needs to activate on the same day you program it.

UW# Group Disable

Default: 00:00
Selection: HH:MM (hours and minutes)



This prompt must be programmed if this User Group Window is assigned to a user group.

Enter the time of day when the window ends. This time marks the end of the period in which users assigned to this window's group can use their pass codes. The window stops at the end of the minute. Make entries using a 24-hour clock (for example, 7:00 AM is entered as 07:00, 2:45 PM is entered as 14:45).

To disable the window, both the hours and minutes spaces must be blank.

Do not program a single window to cross the midnight boundary. The window stop time must be later than the window start time.

5.1.3 Holiday Indexes for User Group Windows

You can enable up to four Holiday Indexes to use with User Group Windows. Enable at least one Holiday Index if **UW# Xept Holiday** is programmed as **Yes** for this user window, or if you want this window to activate only on specific dates. Holidays are programmed in Holiday Indexes. Refer to *Section 5.3 Holiday Indexes* on page 117 for programming information.

UW# Xept Holiday

Default: No
Selection: Yes or No

Determine if the window is disabled on holidays, or is active only on holidays. Use the instructions provided in the **W# Xept Holiday** prompt in *Section 5.1.1 Opening and Closing* on page 99.

UW# Holiday 1 [through 4]

Default: No
Selection: Yes or No

Yes	The selected holiday index can be used by users in the User Group window.
No	The selected holiday index does not apply to users in this User Group.

5.2 Skeds

Use the Skeds module to program the control panel to automatically execute functions that are otherwise started by the end user at the keypad. Each sked can be programmed to occur at a specific time on a specific date or day of the week. Up to 40 Skeds can be programmed.

A sked can be edited from the keypad if **S## Time Edit?** is **Yes**. The date and time can be changed using the Change Sked function.

Each sked number can be programmed with one of 24 functions for the **S## Function Code**. In addition to the function, a choice must be made as to what is affected by the function. For example, when choosing Function 2 (Disarm Sked), the disarming is the function and the selected areas are what is affected.

The functions and their associated parameters are listed in the Sked Function Code Table in the *D9412GV/D7412GV2 Program Record Sheet* (P/N: F01U003635), and they are explained in detail following the **S## Function Code** prompt on page 109.

Each sked can be programmed with up to four Holiday Indexes. The Holiday Indexes can execute the sked on the holidays as well as on the date or day(s) of the week, or, they can prevent the sked from executing on the holidays (refer to **S## Xept Holiday** prompt in this section).

Sked Number

Default: 1
Selection: 1 to 40

Enter the number of the sked you are programming.

S## TimeEdit

Default: Yes
Selection: Yes or No

Yes	The user can edit the time of this sked from the keypad and determines if this sked appears in the CHG SKED display.
No	The user cannot edit the time of this sked from the keypad and the sked does not appear in the CHG SKED display.

Select whether the user can edit the time of this sked from the keypad.

S## Function Code

Enter the function code you want this sked to execute. Sked Function 12 is reserved and is not a valid entry.

The D5200 Programmer automatically retrieves the appropriate sub-menu when the user enters a function code. Refer to the following examples:

- **Example 1:** When Function Code 1 (Arm Area) is entered, the **S## Area 1 [through 8]** prompt appears.
- **Example 2:** When Function Code 3 (Bypass a Point) is entered, the **S## Point Number** prompt appears.

After you program the parameter choices associated with the Sked function, press [EXIT GROUP] to continue programming the sked for date, day of week, time, and holiday.

Default: Blank				
Selection: 1 to 11, 13 to 24, 28, 29				
1	Arm Area: This function simulates the Master Arm Delay keypad function. Entries in the S## Area # prompts define the area(s) this sked arms. The sked can arm multiple areas. If any point is faulted when the sked executes, it is force armed regardless of the A# FA Bypass Max setting.	<div style="border: 1px solid black; padding: 2px; display: inline-block;">S## Area 1 [through 8]</div> Default: No Selections: Yes or No Enable the sked to arm the areas indicated with Yes .	Yes No	Arm Area #. Do not arm Area #.
2	Disarm Area: This function emulates the Disarm_ _ _ keypad function. Entries in the S## Area # prompts define the area(s) this sked disarms. The sked can disarm multiple areas.	<div style="border: 1px solid black; padding: 2px; display: inline-block;">S## Area 1 [through 8]</div> Default: No Selection: Yes or No Enable the sked to disarm the areas indicated with Yes .	Yes No	Disarm Area #. Do not disarm Area #.
3	Bypass a Point: This function emulates the Bypass Pt? keypad function. The entry in the S## Point Number prompt defines the point this sked bypasses. The point can be bypassed only if Bypassable is programmed Yes in the point index assigned to the point. The bypass is reported if the Bypass Reports is enabled by the point index settings assigned to the point. The sked can bypass one point.	<div style="border: 1px solid black; padding: 2px; display: inline-block;">S## Point Number</div> Default: Blank Selections: Blank, 1 to 127, 129 to 247 for D9412GV2, 1 to 75 for D7412GV2 Enter the number of the point the sked bypasses.	Blank (0) 1 to 127, 129 to 247	No point is bypassed Point to bypass
4	Unbypass a Point: This function emulates the Unbypass Pt? keypad function. The entry in the S## Point Number prompt defines the point this sked unbypasses. The sked can unbypass one point.	<div style="border: 1px solid black; padding: 2px; display: inline-block;">S## Point Number</div> Default: Blank Selections: Blank, 1 to 127, 129 to 247 for D9412GV2, 1 to 75 for D7412GV2 Enter the number of the point the sked unbypasses.	Blank (0) 1 to 127, 129 to 247	No point is unbypassed. Point to unbypass.

Default: Blank				
Selection: 1 to 11, 13 to 24, 28, 29				
5	<p>Unbypass All Points: This function is not available as a keypad function. The entry in the S## Area # prompt defines the area(s) where the sked unbypasses all points. The sked unbypasses all points in the area, regardless of how they were bypassed. This sked can unbypass all points in multiple areas.</p>	<p>S## Area 1 [through 8]</p> <p>Default: No Selection: Yes or No Select Yes to unbypass all points in the areas indicated.</p>	<p>Yes</p> <p>No</p>	<p>Unbypass all points in Area #.</p> <p>Do not unbypass all points in Area #.</p>
6	<p>Relay On: This function emulates the Chg Relay keypad function to turn relays on. The entry in the S## Relay Number prompt defines the specific relay this sked activates. The sked can activate one relay.</p>	<p>S## Relay Number</p> <p>Default: Blank Selections: Blank, 1 to 128 for D9412GV2, 1 to 64 for D7412GV2 Enter the number of the relay the sked activates</p>	<p>Blank</p> <p>1 to 128</p>	<p>No relay is activated.</p> <p>Relay to activate.</p>
7	<p>Relay Off: This function emulates the Chg Relay? keypad function to turn relays off. The entry in the S## Relay Number prompt defines the relay this sked turns off. The sked can turn off only relays that are set by a sked. The sked can turn off one relay.</p>	<p>S## Relay Number</p> <p>Default: Blank Selections: Blank, 1 to 128 for D9412GV2, 1 to 64 for D7412GV2 Enter the number of the relay that turns the sked off.</p>	<p>Blank</p> <p>1 to 128</p>	<p>No relay is turned off.</p> <p>Relay to turn off.</p>
8	<p>All Relays Off: This function is not available as a keypad function. This sked function turns off all relays that are turned on by a sked. This is a panel-wide function.</p> <p>No other parameters require input for this option.</p>			

Default: Blank Selection: 1 to 11, 13 to 24, 28, 29				
9	<p>Test Report: This function emulates the Send Report? keypad function. This function generates a Test Report only from Area 1 but contains panel-wide status information. The report is sent to the phone(s) programmed for Test and Status Reports in <i>Section 2.3.8 Dialing Attempts</i> on page 14.</p> <p>If <i>Expand Test Prt</i> in Phone parameters is programmed as Yes, the Test Report also includes all off-normal states for events listed in Diagnostic Reports and Test Reports (refer to <i>Section 2.3.8 Dialing Attempts</i> on page 14).</p> <p>The Test Report can be deferred if any other report was sent since the last Test Report. To defer the Test Report, program <i>S## Defer Test</i>.</p> <p>The Test Report can be sent every hour beginning at the time scheduled in <i>S## Time</i>. To send a Test Report every hour, program <i>S## Hourly Rpt</i>.</p>	<div style="border: 1px solid black; padding: 2px; text-align: center;">S## Defer Test</div> <p>Default: No Selection: Yes or No</p> <p>Enable sked to defer the Test Report</p>	<p>Yes</p> <p>No</p>	<p>Defer the Test Report.</p> <p>Send the Test Report on schedule.</p>
		<div style="border: 1px solid black; padding: 2px; text-align: center;">S## Hourly Report</div> <p>Default: No Selection: Yes or No</p> <p>Select Yes to send the Test Report every hour.</p>	<p>Yes</p> <p>No</p>	<p>Send the Test Report every hour.</p> <p>Send the Test Report only as scheduled.</p>
10	<p>Status Report: This function generates a Status Report for each area that is enabled. The report is sent to the phone(s) programmed for Test and Status Reports in Routing.</p> <p>The Status Report can be deferred if any other report was sent since the last Status Report. To defer the Status Report, program <i>S## Defer Status</i>.</p>	<div style="border: 1px solid black; padding: 2px; text-align: center;">S## Defer Status</div> <p>Default: No Selection: Yes or No</p> <p>Enable sked to defer the Status Report.</p>	<p>Yes</p> <p>No</p>	<p>Defer the Status Report.</p> <p>Send the Status Report on schedule.</p>

Default: Blank				
Selection: 1 to 11, 13 to 24, 28, 29				
11	<p>Execute Custom Func: This function emulates any of the custom functions assigned to the keypad that can be executed by a user from the keypad. When a sked executes a custom function, it is subject to the scope of the selected keypad. <i>Cmd Center</i> and <i>Custom Func</i> prompts appear after entering Function Code 11. Both entries are required.</p>	<p>S## Cmd Center</p> <p>Default: Blank (0) Selections: Blank (0), 1 to 8</p> <p>Identify the specific keypad (CC #) where the Custom Function is entered. Only one keypad can be assigned for this sked function.</p>	<p>Blank (0)</p> <p>1 to 8</p>	<p>No keypad is specified for Custom Function activation.</p> <p>Command center (keypad) address specified for Custom Function activation.</p>
		<p>S## Custom Func</p> <p>Default: Blank (0) Selections: Blank (0), 128 to 143 for D9412GV2, 128 to 131 for D7412GV2</p> <p>Enter the custom function this sked executes.</p>	<p>Blank (0)</p> <p>128 to 143</p>	<p>No Custom Function is activated.</p> <p>Custom Function to activate.</p>

 Avoid having multiple functions occur at the same time at the same address. Functions can clash and the effect on the control panel is unpredictable.

 Ensure that the Custom Function being executed or any of the commands nested inside the Custom Function are not pass-code protected.

 Do not program multiple skeds to execute at the same keypad during the same time.

Do not program skeds to execute at times when a user is likely to be executing functions at the keypad. If it is necessary to do so, there are two ways to work around the situation:

1. Program CC at the beginning of the Custom Function Key Strokes entry. This aborts the user's function and allows the sked to execute.
2. Program the sked to execute at an address (Cmd Center) with no keypad physically attached to it. The CC # must be assigned to an area and have the appropriate scope programmed.

Default: Blank	
Selection: 1 to 11, 13 to 24, 28, 29	
13	<p>Adjust Time Forward One Hour: This sked function is used to make adjustments to the control panel's clock. A typical application is to program this to go into effect at 2:00 AM on the date that Daylight Saving Time begins (during the springtime). No Time Change Report is sent or logged, but the new time appears in the next report logged.</p> <p>No other parameters require input for this option.</p>

Default: Blank				
Selection: 1 to 11, 13 to 24, 28, 29				
18	Unlock Door: This function emulates the UNLOCK? 12345678 keypad function for unlocking a door.	<input type="text" value="S## Door 1 [through 8]"/> Default: No Selection: Yes or No Enable the sked to unlock the doors programmed Yes .	Yes No	Unlock Door #. Do not unlock Door #.
19	Secure Door: This function emulates the SECURE? 12345678 keypad function for securing a door.	<input type="text" value="S## Door 1 [through 8]"/> Default: No Selection: Yes or No Enable the sked to return the doors programmed Yes to the secured state.	Yes No	Secure Door #. Do not secure Door #.
20	Lock Door: This function returns an unlocked (Function 18) or secured (Function 19) door to a normal locked door state.	<input type="text" value="S## Door 1 [through 8]"/> Default: No Selection: Yes or No Enable the sked to lock the doors programmed as Yes and return them to the normal Door Mode.	Yes No	Lock Door #. Do not lock Door #.
21	Access Authority Events On: The control panel can log Access Granted Events when a valid token, RTE, REX, or Unlock Door event is detected for a specific door. These events can be directed to print at a local printer or send a report remotely through phone routing. This sked enables Access Granted Events to be reported for Door #.	<input type="text" value="S## Door 1 [through 8]"/> Default: No Selection: Yes or No This parameter enables the sending of Access Granted Events for Door #.	Yes No	Enable the sending of Access Granted Events for Door #. Do not enable the sending of Access Granted Events for Door #.
22	Access Authority Events Off: The control panel can log Access Granted Events when a valid token, RTE, REX, or Unlock Door Event is detected for a specific door. These events can be directed to print at a local printer or send a report remotely through phone routing. This sked disables Access Granted Events to be reported for Door #.	<input type="text" value="S## Door 1 [through 8]"/> Default: No Selection: Yes or No This parameter disables the sending of Access Granted Events for Door #.	Yes No	Disable the sending of Access Granted Events for Door #. Do not disable the sending of Access Granted Events for Door #.

Default: Blank			
Selection: 1 to 11, 13 to 24, 28, 29			
23	No Entry Events On: The control panel can log No Entry Events when an invalid token is detected for a specific door. No Entry Events include No Entry-Secured, No Entry-Interlock, No Entry-Unknown ID, and No Entry-Level. These events can be directed to print at a local printer or send a report remotely through phone routing. This sked enables No Entry Events to be reported for Door #.	<div style="border: 1px solid black; padding: 2px; width: fit-content; margin-bottom: 5px;">S## Door 1 [through 8]</div> Default: No Selection: Yes or No This parameter enables the sending of No Entry Events for Door #.	Yes Enable the sending of No Entry Events for Door #. No Do not enable the sending of No Entry Events for Door #.
24	No Entry Events Off: The control panel can log No Entry Events when an invalid token is detected for a specific door. No Entry Events include No Entry-Secured, No Entry-Interlock, No Entry-Unknown ID, and No Entry-Level. These events can be directed to print at a local printer or send a report remotely through phone routing. This sked disables No Entry Events to be reported for Door #.	<div style="border: 1px solid black; padding: 2px; width: fit-content; margin-bottom: 5px;">S## Door 1 [through 8]</div> Default: No Selection: Yes or No This parameter disables the sending of No Entry Events for Door #.	Yes Enable the reporting of No Entry Events for Door #. No Do not enable the reporting of No Entry Events for Door #.
28	Expanded Off-Normal Test Report: To generate this event, one or more points must be in an off-normal state at the time the sked executes. In addition, any system trouble that is active also generates an Expanded Off-Normal Test Report. Expanded Off-Normal Test Reports include the Off Normal Test Report Event as well as the supplementary event at the time the report is generated. The Event Log shows only a Test Report Event. If none of these conditions exists at the time the sked executes, only a Sked Executed Event is generated and the Off-Normal Test Report is not sent.		

29	Non-Expanded Off-Normal Test Report: Non-Expanded Off-Normal Test Report Events are only sent when any point is in the off-normal state from any area, but only sends the Off Normal Test Report Event. Any system trouble that is active also generates a Non-Expanded Off-Normal Test Report. The Event Log only shows a Test Report Event. If none of these conditions exist at the time the sked executes, only a Sked Executed Event is generated and the Non-Expanded Off-Normal Test Report is not sent.
----	--

 To meet UL 864 daily Test Report requirements (when using two phone lines), you must still use Sked Function Code 9, Test Report and program it to occur on a daily basis as per AHJ requirements.

S## Time**Default:** 00:00**Selection:** HH:MM (hours and minutes)

Enter the time that the sked executes. Make entries using a 24-hour clock (for example, 7:00 AM is entered as 07:00, 2:45 PM is entered as 14:45).

Disabled skeds have a blank time. If you copy the control panel and the entry for this prompt is blank, but times were at one time programmed, the sked can be disabled from the keypad using the Change Skeds function.

To program a time:

1. Press the two digits representing the hour.
2. The cursor advances past the colon (:) in the display.
3. Press the two digits representing the minutes.
4. Press [ENTER].

S## Date**Default:** __/ __**Selection:** MM/DD (month and date)

Enter the date that the sked executes.

Disabled skeds have a blank date. If you copy the control panel and the entry for this prompt is blank, but dates were programmed before, the sked can be disabled from the keypad using the Change Skeds function.

To program a date:

1. Press the two digits representing the hour.
2. The cursor advances past the colon (:) in the display.
3. Press the two digits representing the minutes.
4. Press [ENTER].

S## Sunday**Default:** No**Selection:** Yes or No

Yes Activate this sked on Sundays.

No Do not activate this sked on Sundays.

This prompt and the next six prompts select the days of the week when the sked is active.

Exceptions:

To prevent the sked from activating on certain days of the year, program *Xept Holiday* as **Yes**, and enable at least one Holiday Index. When *Xept Holiday* is programmed as **Yes**, the window executes on the days of the week programmed unless the date is designated as a holiday by the Holiday Index selected.

If a sked is only needed on certain days of the year, do not program the sked to execute on specific days of the week. Instead, program *Xept Holiday* as **No**, and select a Holiday Index with the dates you want the window to be active.

S## Monday**Default:** No**Selection:** Yes or No**S## Tuesday****Default:** No**Selection:** Yes or No**S## Wednesday****Default:** No**Selection:** Yes or No**S## Thursday****Default:** No**Selection:** Yes or No**S## Friday****Default:** No**Selection:** Yes or No**S## Saturday****Default:** No**Selection:** Yes or No

S## Xept Holiday

Default:	No
Selection:	Yes or No
Yes	Prevent this sked from operating on the holidays identified in the specific Holiday Index(es) used with this sked. Specific Holiday Indexes are selected in this programming section and programmed in the next programming module.
No	This sked operates on holidays programmed in the Holiday Index(es) used with this sked.

If no days of the week are programmed, this sked operates only on the holidays programmed in the Holiday Index(es) used with this sked. This sked also operates if the holiday falls on a day of the week that is programmed.

S## Holiday 1

Default:	No
Selection:	Yes or No
Yes	Use Holiday Index 1 with this sked.
No	Do not use Holiday Index 1 with this sked.

S## Holiday 2

Default:	No
Selection:	Yes or No

S## Holiday 3

Default:	No
Selection:	Yes or No

S## Holiday 4

Default:	No
Selection:	Yes or No

5.3 Holiday Indexes

This programming module has two sections: Add/Change/Delete and View Holidays. Use the Add/Change/Delete section to program the Holiday Indexes. The View Holidays section is a view-only section provided for your convenience. Use View Holidays to review the dates programmed in the Holiday Indexes.

5.3.1 Add/Change/Delete

Program the dates for each of the Holiday Indexes. You can program up to four Holiday Indexes in the control panel. Within each index, you can select up to 365 dates to be designated as holidays.

The Holiday Indexes function independently of each other. The same day can be programmed in all four schedules. Holiday Indexes are used in programming O/C Windows, User Access Windows, and skeds.

Date

Default:	-- / --
Selection:	MM/DD (month and date)

This entry selects the month and day you are designating as a holiday.

To program a date:

1. Press the two digits representing the month. The cursor advances past the slash (/) in the display.
2. Press the two digits representing the day of the month.
3. Press [ENTER].

To delete a date:

1. At the **Date** prompt, enter the month and day you want to delete and press [ENTER].
2. Advance to the holiday index number that you want to delete the date from. Change the entry to **No**. Press [ENTER].

If you want the date completely removed as a Holiday, it must be programmed as **No** for all of the Holiday Index # entries.

Holiday Index 1

Default:	No
Selection:	Yes or No
Yes	Use this date in Holiday Index 1.
No	Do not use this date in Holiday Index 1.

Holiday Index 2

Default:	No
Selection:	Yes or No

Holiday Index 3

Default:	No
Selection:	Yes or No

Holiday Index 4

Default:	No
Selection:	Yes or No

5.3.2 View Holidays

The View Holidays section is a view only section provided for your convenience. Use View Holidays to review the dates you programmed into each of the Holiday Indexes.

You can view the first 100 dates programmed in each of the indexes.

Index 1 Days

Default:	Blank
Selection:	Enter group or press [↓] key

Press [ENTER GROUP] to view the dates programmed in *Holiday Index 1*.

Press [↓] key to advance to the next Holiday Index.

Index 2 Days

Default:	Blank
Selection:	Enter group or press [↓] key

Index 3 Days

Default:	Blank
Selection:	Enter group or press [↓] key

Index 4 Days

Default:	Blank
Selection:	Enter group or press [↓] key

6.0 GV2AUX

6.1 Introduction

The GV2AUX Handler is used primarily for programming Enhanced Communication capabilities for the 9000GV2 Series Control Panels.

“Enhanced communications” represents the ability to provide new communication functions for the control panels using the SDI bus including:

- Routing control panel events to a network interface module (NIM).



A network interface module (NIM) can be a D9133TTL-E or a DX4020.

- Communicating with remote programming software (RPS) using a network interface module (NIM).
- Communicating with a remote or local automatic software package.

6.2 RPS and D5200 Handler Requirements

In order to program the GV2AUX parameters for the control panels, you must use RPS version 3.8 or higher and a handler called GV2AUX. To add the GV2AUX Handler to your D5200 Programmer, call the Bosch Security Systems Handler Update System at (800) 657-4584.

This handler currently has six sections:

- SDI Automation
- SDI RPS Parameters
- Enhanced Communications
- SDI RPS/Enhanced Communication Configuration
- Miscellaneous
- Cross Point Parameters

The handler required for these options is GV2AUX version 1.0 and above. It is available on the Handler Update System at Bosch Security Systems.

6.3 SDI Automation

SDI automation defines the characteristics of a serial interface module (SIM) when used with home or business automation software. The SIM is a two-way SDI to an RS-232 interface module that allows the control panels to send and receive information to and from an external software program.



The SIM can be a D9133 or a DX4010.

This automation protocol allows external software programs to interact and perform functions such as:

- arming and disarming areas,
- changing user pass codes and names, and
- turning relays on and off.

The items described in this section allow some simple configuration options. To receive the SIM automation protocol; however, you must contact Bosch Security Systems Technical Support at 888-886-6189.

Enable SDI Auto

Default:	No
Selection:	Yes or No
Yes	Enable Automation software.
No	Disable Automation software.

Changing this item to **Yes** enables the automation address (SDI Address 80).

Baud Rate

Default:	9600
Selection:	300, 1200, 2400, 4800, 9600, 14.4 K

This item determines the baud rate between the serial interface module (SIM) and the external hardware connected to it. Since the SDI bus communicates at 9600 baud, keep this prompt at 9600 baud. Pressing the [SPACE] bar on the D5200 toggles through the available options.

Parity/Stop

Default:	No/1
Selection:	No/1, No/2, Odd/1, Even/1
No/1	No parity, 1 stop bit
No/2	No parity, 2 stop bits
Odd/1	Odd parity, 1 stop bit
Even/1	Even parity, 1 stop bit

This prompt addresses two items: parity and the number of stop bits. Pressing the [SPACE] bar on the D5200 toggles through the available options.

9133 Supervision

Default:	No
Selection:	Yes or No
Yes	Supervise the serial interface module (SIM).
No	Do not supervise the serial interface module (SIM).

This item determines whether the serial interface module (SIM) is supervised or not. If the SIM is supervised, disconnecting the SIM from the control panel creates a Trouble SDI 80 Event and the keypad annunciates a trouble tone (if programmed) and displays `SERV C SDI 80`.



Trouble SDI 80 Reports are always sent using the account number for Area 1.

RTS Control

Default:	On
Selection:	On, AutoX, Off, AutoR
On	Sets RTS to on (hardware control).
AutoX	Automatically enables Xon/Xoff (software control).
Off	Sets RTS off (hardware control).
AutoR	Sets this to Auto RTS.

This item determines how the Request To Send (RTS) Control parameters are defined for the serial interface module (SIM). Pressing the [SPACE] bar on the D5200 toggles through the available options.

DTR Control

Default:	On
Selection:	On, AutoD, Off
On	Sets DTR to on (hardware control).
AutoD	Sets this to Auto DTR.
Off	Sets DTR off (hardware control).

This item determines how the Data Terminal Ready (DTR) Control parameters are defined for the D9133. Pressing the [SPACE] bar on the D5200 toggles through the available options.

Status Rate

Default:	0
Selection:	0 to 255
0	Status information is sent only when requested.
1 to 255	Status information is sent at the interval programmed.



If the Status Rate is set to a value less than 10, and 1 to 6 SDI devices are connected to the system, the fastest the control panel can send the status information is in approximately 1 sec. If more than six SDI devices are connected to the control panel, the fastest the control panel can send the information is in approximately 1.5 sec to 2 sec.

This item determines how often the default status information is sent to the serial interface module (SIM). The status information includes:

- The current point status (normal or off-normal),
- The control panel's area status (Master Armed, Master Instant Armed, Perimeter Delay Armed, Perimeter Instant Armed, Disarmed, Area Entry Delay, Perimeter Entry Delay, Area Exit Delay, and Perimeter Exit Delay)
- The control panel status (AC Fail, Battery Missing, AC Restore, Battery Low, and so on)
- Relay status (relay on or relay off)

Entries are in 100 millisecond increments. If a 5 is entered, the status information is sent every 500 milliseconds (or 0.5 seconds). An entry of 10 equals 1 second.

6.4 SDI RPS Parameters

Configure remote programming software (RPS) parameters when communicating over a private local-area network (LAN) or wide-area network (WAN). To allow RPS to communicate with a control panel over a LAN or WAN, an SDI-Ethernet two-way network interface module (NIM) and an RPS (version 3.8 or higher) are required. The computer on which RPS is installed needs a network card. See your information systems administrator for network requirements.

This section allows you to:

- Define the RPS parameters necessary to communicate by an external modem that can be connected to a D9133DC Direct Connect Programming Module.
- Provide for local programming by a D9133 Serial Interface Module.

Although not listed in this section, RPS checks for the RPS pass code (refer to *Section 2.7 RPS Parameters* on page 28), Datalock Code, and control panel type to determine if this RPS session should continue.

Pressing the [ESC] key during the display of CONTACT RPS?, ANSWER NOW?, RPS VIA PHONE?, or RPS VIA NETWORK? exits the user to Idle Text.



The *RPS via Phone?* prompt (*Figure 6* on page 122), if selected, contacts RPS by the control panel phone line and not the external modem. Users cannot start an RPS session by the external modem. If you are using an external modem, RPS sessions can be started only by programming Answer Armed and Answer Disarmed (to a value greater than 0) or by setting *RPS Line Monitor* to **Yes** (refer to *Section 6.4.2 Using an External Modem* on page 123).

6.4.1 User Interface Modifications for COMMAND 43

COMMAND 43 can communicate with RPS by a network path. *Figure 6* on page 22 shows the structure of COMMAND 43.

Enable SDI RPS	
Default:	Yes
Selection:	Yes or No
Yes	Enable RPS sessions over the SDI bus.
No	Do not enable RPS sessions over the SDI bus.

Enable SDI RPS determines if the control panel allows RPS communications over the SDI bus. This item must be set to **Yes** if you plan to use the external modem configuration, a private LAN or WAN, or local RPS programming.



If the reset pin is in the locked position, local RPS programming is allowed even if this prompt is set to **No**.



When *Enable SDI RPS* is configured to allow for local programming, Jumper 8 in the SIM must be shorted or closed, power must be removed and reapplied after changing the address, and a standard serial null-modem cable is required.

Call Back Enabled

Default:	No
Selection:	Yes or No
Yes	When the control panel hears the correct RPS password (refer to <i>RPS Passcode</i> in <i>Section 2.7 RPS Parameters</i> on page 28), it ends the SDI RPS session and then reconnects to RPS using the RPS IP Address if <i>Enable Ext Modem</i> is set to No . If <i>Enable Ext Modem</i> is set to Yes , the control panel re-establishes communication with RPS using the RPS Dial String. This ensures that the control panel communicates only with valid RPS units.
No	The SDI RPS session starts immediately; no call-back is required. The control panel can engage in SDI RPS sessions regardless of the originating location.

Using this function allows the control panel, after verifying the RPS pass code, to provide an additional level of security. Before allowing any upload or download, it ends the SDI RPS session and then reconnects with RPS using one of the following:

- The RPS IP Address (*Enable Ext Modem* must be set to **No**)
- The RPS Dial String (*Enable Ext Modem* must be set to **Yes**)



Do not enable RPS Call Back when using an external modem.

Figure 6: COMMAND 43 Flow Chart

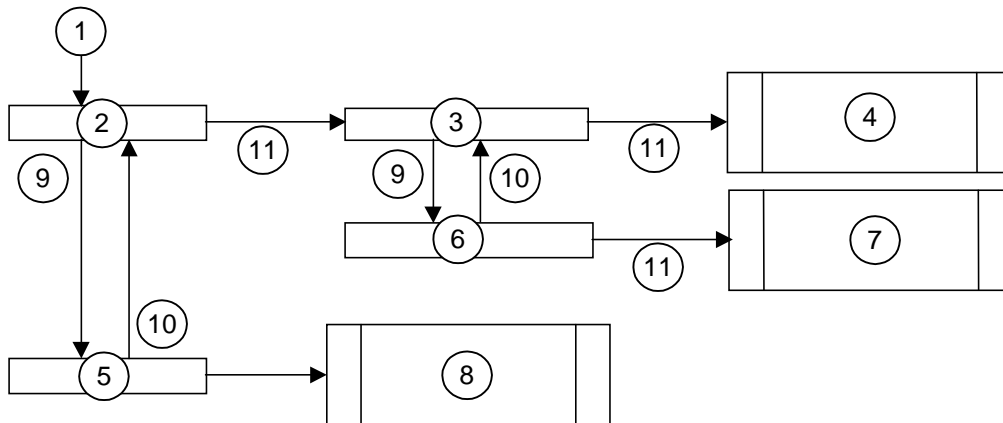

- | | |
|---|--|
| <ul style="list-style-type: none"> 1 - COMMAND 43 2 - Contact RPS? 3 - RPS via Phone? 4 - Seizes phone line and calls RPS 5 - Answer now? 6 - RPS by network? | <ul style="list-style-type: none"> 7 - Begins RPS session over the network 8 - Seizes phone line and begins RPS session 9 - [PREV] 10 - [NEXT] 11 - [ENT] |
|---|--|

RPS IP Address 1

Default:	0
Selection:	0 to 255
0 to 255	Enter the first three digits of the IP address. Leading zeros are not required.

This prompt and the next three prompts determine the IP address for RPS.

An IP address has four fields. Each field has a range of 0 to 255. For example, an IP address is expressed as 110.227.64.190. (Refer to *Figure 7*.) The D5200 programmer divides the IP Address into four programmable fields. Contact your network administrator to determine the IP address to which the RPS computer is connected.

Figure 7: RPS IP Address Prompts

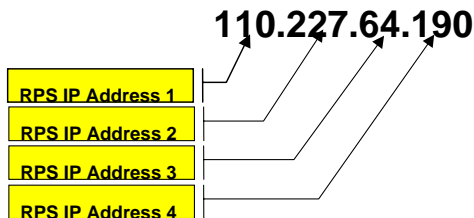

Set **RPS IP Address** to 0 if **Enable Ext Modem** is set to **Yes**.

RPS IP Address 2

Default:	0
Selection:	0 to 255

Refer to **RPS IP Address 1**.

RPS IP Address 3

Default:	0
Selection:	0 to 255

Refer to **RPS IP Address 1**.

RPS IP Address 4

Default:	0
Selection:	0 to 255

Refer to **RPS IP Address 1**.

6.4.2 Using an External Modem

Through the use of a standard, off-the-shelf modem (capable of communicating at 9600 baud) and a D9133DC connected directly to the control panel, RPS can communicate with a D9412GV2 or D7412GV2 at speeds of up to 9600 baud.



Both the U.S.Robotics V.92 56 K Modem (model No. 5686, includes V.92 and V.90 56 K standard technology) and the Best Data Smart One V.92/V.44 56 K External Data/Fax Modem (model # 56SX-92) are recommended for use as external modems (connected to the control panel) based on compatibility testing by Bosch Security Systems. Other modules were not tested or were incompatible.

The seven prompts on page 126 help to configure the requirements necessary to connect an external modem to a D9412GV2 or D7412GV2 Control Panel using a D9133DC. This configuration allows communication with RPS at 9600 baud because data is routed through the SDI bus.



Use a separate phone line if an external modem is being connected to the control panel by a D9133DC Direct Connect Programming Module. If obtaining a different phone line from the line used by the control panel is impossible, ensure that the control panel is wired in front of any premises phone and the external modem devices so that full line seizure is maintained. Also, ensure that the following items are programmed in *Section 2.7 RPS Parameters* on page 28:

- **Answer Armed** = Blank or 0
- **Answer Disarmed** = Blank or 0
- **RPS Line Monitor** = No
- **RPS Call Back** = No
- **RPS Phone number** = Blank



When using an external modem, initialize it using the following HyperTerminal procedure on your computer. The HyperTerminal procedures can vary, depending upon the operating system.

1. In Windows®, open the HyperTerminal application. Select:
Programs→Accessories→Communications
2. Connect the modem to an available COM port.
3. With the modem connected, select the appropriate COM port within HyperTerminal. Refer to *Figure 8* on page 124.
4. Set the baud rate of the modem to 9600.



For Best Data Smart One V.92:
Type [A][T][S][3][7][=][9][Enter]

For US Robotics:
Type [A][T][&][N][6][Enter]

For other modems, consult the instructions provided with the device for the correct text string.

5. Type [A][T][E][0][Enter]. This eliminates echo, making all user input from this point forward invisible on the screen.
6. Type [A][T][&][W][0][Enter] to write the configuration to modem memory. The modem profile is saved to a file upon disconnection or power loss.

The external modem is connected to the D9133DC Direct Connect Programming Module that is connected to the SDI bus using SDI Address 88. Refer to *Figure 9* on page 124. A standard serial cable is required to connect the D9133DC to the external modem.



If you are using an external modem for RPS communications, the enhanced communications and RPS functions using a NIM are disabled.

Figure 8: Com Port Selection within HyperTerminal

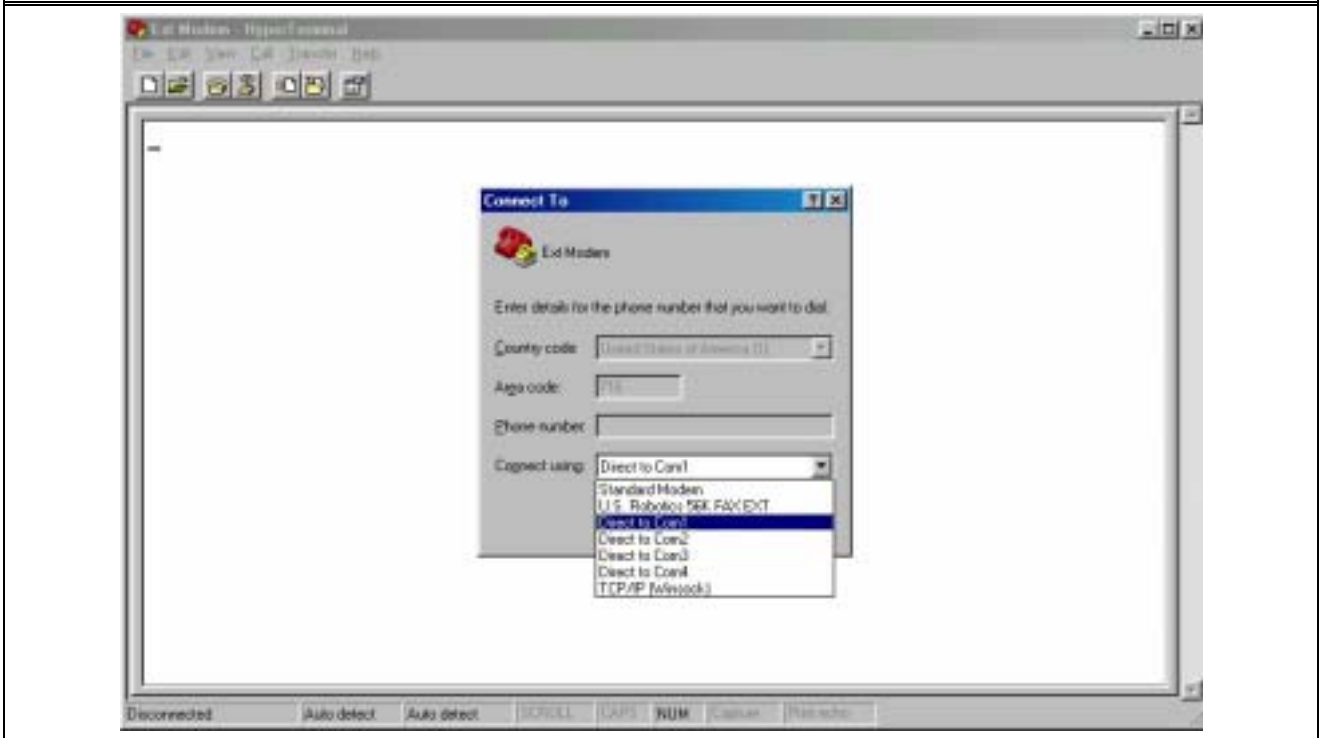
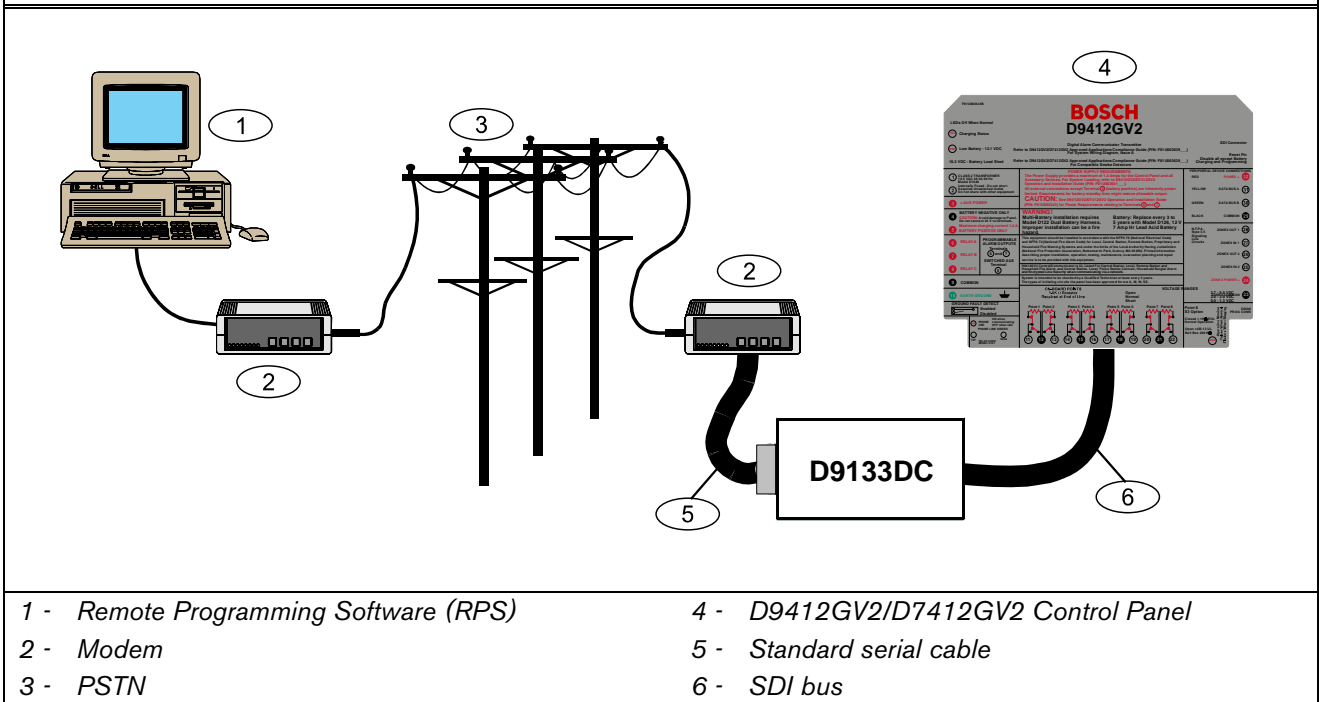

Figure 9: External Modem Connection





To use an off-the-shelf external modem and a D9133DC serial module to connect to the control panel using RPS, use the following settings:

1. GV2AUX\ENHANCED COMM\Enhanced Comm\No
2. GV2AUX\SDI RPS PARAMETERS\Enable SDI RPS\Yes
3. GV2AUX\SDI RPS PARAMETERS\Callback Enabled\No
4. GV2AUX\SDI RPS PARAMETERS\RPS IP Address 1-4\0
5. GV2AUX\SDI RPS PARAMETERS\Enable Ext Modem\Yes
6. GV2AUX\SDI RPS PARAMETERS\Answer Armed\1 to 15
7. GV2AUX\SDI RPS PARAMETERS\Answer Disarmed\1 to 15
8. GV2AUX\SDI RPS PARAMETERS\RPS Line Monitor\No
9. GV2AUX\SDI RPS PARAMETERS\Seize Relay\No
10. GV2AUX\SDI RPS PARAMETERS\Modem Init String\ATE0
11. GV2AUX\SDI RPS PARAMETERS\RPS Dial String\ (blank)
12. GV2AUX\SDIRPS/ENHANCED CONF\Baud Rate\9600
13. GV2AUX\SDIRPS/ENHANCED CONF\Parity/Stop No\1
14. GV2AUX\SDIRPS/ENHANCED CONF\RTS Control\ON
15. GV2AUX\SDIRPS/ENHANCED CONF\DTR Control\ON
16. GV2AUX\SDIRPS/ENHANCED CONF\9133 Supervision\No
17. GV2MAIN\PANEL WIDE PARAMETER\Enhanced Routing\RG1 Primary SDI\No
18. GV2MAIN\PANEL WIDE PARAMETER\Enhanced Routing\RG1 Backup SDI\No
19. GV2MAIN\PANEL WIDE PARAMETER\Enhanced Routing\RG2 Primary SDI\No
20. GV2MAIN\PANEL WIDE PARAMETER\Enhanced Routing\RG2 Backup SDI\No
21. GV2MAIN\PANEL WIDE PARAMETER\Enhanced Routing\RG3 Primary SDI\No
22. GV2MAIN\PANEL WIDE PARAMETER\Enhanced Routing\RG3 Backup SDI\No
23. GV2MAIN\PANEL WIDE PARAMETER\Enhanced Routing\RG4 Primary SDI\No
24. GV2MAIN\PANEL WIDE PARAMETER\Enhanced Routing\RG4 Backup SDI\No
25. The control panel reset pin can be up or down.
26. The modem at the control panel location must be set for 9600 baud and echo off. This information must be written to the modem configuration area. Hyperterminal can be used to send the following Hayes modem commands (refer to the modem's manual for command syntax):
 - AT37=9 (set baud rate to 9600)
 - ATE0 (eliminate echo)
 - AT&W0 (write configuration to modem memory, not echoed)
27. Ensure that the modem at RPS is set up for 9600 baud.
28. From the control panel communication window on RPS, connect by modem at 9600 baud.

Enable Ext Modem

Default:	No
Selection:	Yes or No
Yes	Enable SDI Address 88 for use with an external modem.
No	Disable SDI Address 88 for use with an external modem.

Setting this item to **Yes** instructs the control panel that SDI Address 88 is enabled for use with an external modem. For further information on Local RPS programming, refer to the *RPS Operations Manual* (P/N: 38849).



Setting this item to **Yes** disables Enhanced Communication and SDI RPS for use over a LAN or WAN.

Answer Armed

Default:	7
Selection:	0 to 15
0	No answer when all areas are Master Armed.
0 to 15	The control panel answers the phone after the specified number of rings when all areas are Master Armed.

Determines the number of rings after which the external modem automatically answers a call if all areas are Master Armed.

Answer Disarmed

Default:	7
Selection:	0 to 15
0	No answer when any area is Perimeter Armed or Disarmed.
0 to 15	The control panel answers the phone after the specified number of rings when any area is Perimeter Armed or Disarmed.

Determines the number of rings after which the external modem automatically answers a call if any area is Perimeter Armed or Disarmed.

RPS Line Monitor

Default: No
Selection: Yes or No

Not used. Keep this item set to **No**.

Seize Relay

Default: No
Selection: Yes or No

Not used. Keep this item set to **No**.

Modem Init String

Default: ATE0
Selection: A to Z (capital letters only), 0 to 9, [SPACE], ! " # \$ % & ' () * + , - . / : ; < = > ? @ [\] ^ _

Determines which initialization string the control panel sends to the external modem when the control panel powers up.



If special characters are required, **Modem Init String** can be programmed successfully only from RPS. The D5200 Programmer allows only the characters shown in the **Modem Init String** default selections.

RPS Dial String

Default: ATDT
Selection: Not available

Not used.

6.5 Programming Path Numbers and IP Addresses for Enhanced Communications

Enhanced communications is the ability to communicate by some means other than the standard digital dialer. In this section, programmable parameters allow you to define up to four separate enhanced communication paths to which events can be routed. To route an event (such as an Alarm or Trouble) to an enhanced communication path, additional programming must also be completed in *Section 2.3 Routing* on page 13 and *Section 2.4 Enhanced Routing* on page 21.

Enhanced Comm	
Default:	No
Selection:	Yes or No
Yes	Enable enhanced communications over the SDI bus.
No	Do not enable enhanced communications over the SDI bus.

Determines if the control panel allows enhanced communications over the SDI bus.

- Modem Format** must be set to **Yes** when using enhanced communications.
- Enable Ext Modem** must be set to **No** if enhanced communications are used.
- Enhanced Comm** must be set to **No** if an external modem is used.

- To disable Enhanced Routing completely over an SDI path, **RG#Primary SDI**, **RG#Backup SDI**, and **Enhanced Comm** prompts must all be set to **No**.

Events can be routed to as many as four available paths. If an event (or group of events) is to be routed to an SDI path, the number entered in Primary Device determines which SDI path is used (provided that **RG# Prim, Primary SDI** was set to **Yes** in Routing).

If events are to be routed to an IP address (in a private LAN or WAN application), determine which path is used (Path 1 to Path 4), and enter the appropriate IP Address for that path (refer to **Path # IP Add1** to **Path # IP Add4**).

If events are to be routed to an SDI Path but not to an IP Address, allow the setting for **Path # IP Add#** to remain at 0. **Path # Poll Rate**, **Path # Ack Wait**, and **Path # Retry Count** must be programmed.

Path # IP Add1	
Default:	0
Selection:	0 to 255
0 to 255	Enter the first three digits of the IP address. Leading zeros are not required.

Path # IP Add 1 and the next three items determine the IP addresses for each of the four paths available when using the D5200.

An IP address has four fields. Each field has a range of 0 to 255. For example, an IP address is expressed as 110.227.64.190. The D5200 programmer splits the IP address into four programmable fields (refer to *Figure 10*). Contact your network administrator to determine exactly where to send IP Address Events.

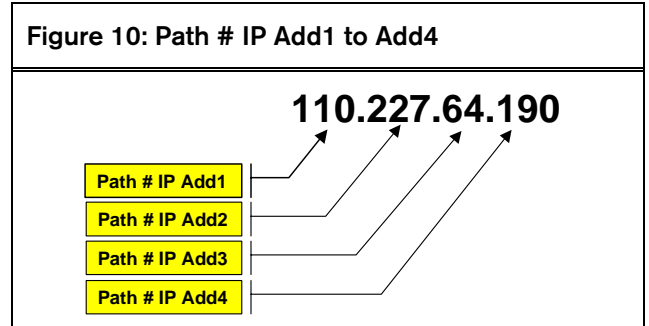

Path # IP Add2	
Default:	0
Selection:	0 to 255

Refer to **Path 1 IP Add1**.

Path # IP Add3	
Default:	0
Selection:	0 to 255

Refer to **Path 1 IP Add1**.

Path # IP Add4	
Default:	0
Selection:	0 to 255

Refer to **Path 1 IP Add1**.

Path # Poll Rate

Default:	0
Selection:	0, 5 to 65535 seconds
0	Disables the heartbeat poll (not recommended, refer to the first Important Note that follows).
5 to 65535	Enables the poll rate for the amount of time programmed here.

This prompt and the next two prompts determine how the SDI Path is supervised between the SDI device and the central station(s). Do not confuse the SDI Path supervision with the supervision of the SDI device itself (the connection of the SDI device to the control panel). Each SDI Path can be configured to transmit a Heartbeat Event to the central station for supervision purposes. This ensures the integrity of the connection at all times.

 When sending reports to a central station receiver over a network path, you **must** set this programming prompt to a non-zero value. Failure to program a value into this field could prevent a failed network communications path from restoring to normal.

 If the control panel is programmed to send Heartbeat Events to the central station, a rate of 60 sec maintains the virtual link in most network configurations. As the poll rate setting decreases, it becomes increasingly difficult to send Heartbeat Events to the central station within the allotted time.



The control panel readjusts the poll rate if it is less than 300 seconds to a temporary poll rate of 300 seconds when online with RPS. The poll rate returns to the programmed value after the RPS session ends.

The value programmed in **Path # Poll Rate** is the interval at which the control panel sends a Heartbeat Event to the central station connected to the same network. The value programmed in **Path # Ack Wait** is the length of time the control panel waits for an acknowledgment of the Heartbeat Event. If the acknowledgment is not received, the control panel checks to determine if the **Path # Retry Count** entry is greater than 0. If so, the control panel retries the number of times programmed (in **Path # Retry Count**) to send the Heartbeat Event before declaring the Path failed and generating a COMM FAIL SDI ## (Path 1 = SDI 88, Path 2 = SDI 89, Path 3 = SDI 90, Path 4 = SDI 91) Event.

If **Path # Poll Rate** is programmed with a value and the central station does not acknowledge the poll from the control panel, keypads do not annunciate a trouble condition. To send this event to the central station, refer to the **Comm Fail** prompt in *Section 2.13.2 Panel-Wide Relays* on page 74.

Example of Heartbeat:

- **Path # Poll Rate** is set to 120 seconds
- **Path # Ack Wait** time is set to 10 seconds
- **Path # Retry Count** is set to 2

When the control panel first powers up, the first Heartbeat Event for Path 1 is sent and is acknowledged in 1 second. 120 seconds after the first Heartbeat Event is sent, the second Heartbeat Event for Path 1 is generated and sent to the central station.

Figure 11: Poll Rate Timeline

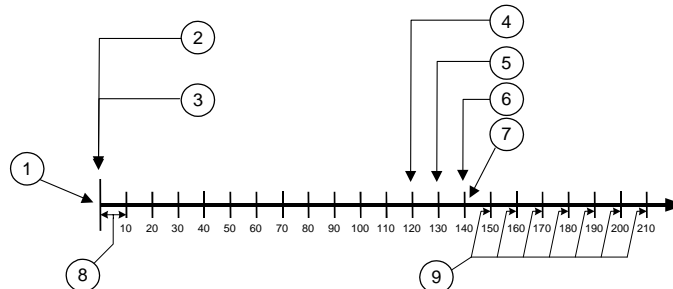

- 1 - Control panel powered up
- 2 - Acknowledgement received
- 3 - Heartbeat Event sent
- 4 - Second Heartbeat Event sent
- 5 - No acknowledgment, Heartbeat re-sent, retry #1

- 6 - No acknowledgment, Heartbeat re-sent, retry #2
- 7 - Path declared failed
- 8 - 10-second interval
- 9 - Additional Heartbeats sent every 10 seconds until acknowledged

Example of Retry Count:

An acknowledgment of the heartbeat was not received within 10 seconds. The control panel sends the Heartbeat Event after the first 10-sec ack wait period expires. If the central station does not acknowledge this Heartbeat Event, the control panel declares this path as failed (and generates the Comm Fail ## Event). The control panel continues to re-send the Heartbeat Event every 10 sec until it receives an acknowledgment.

When the control panel receives acknowledgment from the central station, the control panel returns to the normal Poll Rate (which, in this example, is 120 seconds).

If more than one SDI Path is used, the control panel handles them on a successive basis. For example, if acknowledgment from SDI Path 1 is not received within 10 seconds (using the previous example), the control panel moves to SDI Path 2 to send its Heartbeat Event (and subsequently waits for the ack) before returning to SDI Path 1 to re-send its heartbeat.

 If Heartbeat Events are enabled to send by an SDI path, and the **Path # Ack Wait** time is exceeded, a Comm Fail ## event occurs. When this condition occurs, all events routed to this path go immediately to the backup path.

Entries are made in one-second increments.

 Although RPS and the D5200 allow **Path # Poll Rate** values of 1 to 4, the control panel interprets these entries as an entry of 5.

 5 minutes = 300 seconds
 1 hour = 3600 seconds
 12 hours = 43,200 seconds
 18 hours = 64,800 seconds

Path # Ack Wait

Default:	13
Selection:	0, 5 seconds to 65535 seconds
0	The control panel does not look for any acknowledgment from the central station.
5 to 65535	The control panel waits this amount of time to receive an acknowledgment from the central station.

Determines how long the control panel waits for an acknowledgment from the central station after a Heartbeat Event (poll) or an actual event was transmitted. This prompt is applicable only to SDI transmitted events. Entries are made in one-second increments.

 Although RPS and the D5200 allow **Path # Ack Wait** values of 1 to 4, the control panel interprets these entries as an entry of 5.

 The value entered for **Path # Ack Wait Tone** must not equal the time out entry made in the RPS Account (refer to the RPS *Operation Manual*, version 3.9 or higher). Instead, offset these values by 2 or 3. For example, if your Path # Ack Wait time = 15, program your Time Out value as 17 in the RPS account.

Path # Retry Count

Default:	5
Selection:	0 to 255
0	COMM FAIL RG# SDI ### Events are not generated.
1 to 255	COMM FAIL RG# SDI ### Events are generated after resending Heartbeat Event the number of times for a given SDI path.

Determines how many times the control panel resends the Heartbeat Event before declaring a path failure and generating a COMM FAIL RG# SDI ### (RG # = 1 to 4, SDI ### = 88 for Path 1, 89 for Path 2, 90 for Path 3, 91 for Path 4) Event.

6.6 SDI RPS/Enhanced Communications Configuration

This section provides the necessary prompts for configuring the SDI-Network Interface Module (NIM) when using it for SDI RPS or SDI enhanced communication applications.

Baud Rate

Default: 9600
Selection: 300, 1200, 2400, 4800, 9600, 14.4 K

This item determines the communication baud rate for the network interface module (NIM). Because the SDI bus communicates at 9600 baud, keep this prompt at 9600 baud. Pressing the [SPACE] bar on the D5200 toggles through the available options.



Do not set this value to any setting other than 9600 baud.

Parity/Stop

Default: No/1
Selection: No/1, No/2, Odd/1, Even/1

No/1	No parity, 1 stop bit.
No/2	No parity, 2 stop bits.
Odd/1	Odd parity, 1 stop bit.
Even/1	Even parity, 1 stop bit.

This prompt addresses two items: parity and the number of stop bits for the network interface module (NIM). Pressing the [SPACE] bar on the D5200 toggles through the available options.



Set this item to No/1 when using the External Modem feature.

RTS Control

Default:	On
Selection:	On, AutoX, Off, AutoR
On	Sets RTS to on (hardware control).
Auto X	Automatically enables Xon/Xoff (software control).
Off	Sets RTS off (hardware control).
Auto R	Sets this to Auto RTS.

Determines how the Request To Send (RTS) control parameters are defined for the network interface module (NIM). Pressing the [SPACE] bar on the D5200 toggles through the available options.



Set this item to On when using the External Modem feature.

DTR Control

Default:	On
Selection:	On, AutoD, Off
On	Sets DTR to on (hardware control).
AutoD	Sets this to Auto DTR.
Off	Sets DTR off (hardware control).

Determines how the Data Terminal Ready (DTR) control parameters are defined for the network interface module (NIM). Pressing the [SPACE] bar on the D5200 toggles through the available options.



Set this item to On when using the External Modem feature.

9133 Supervision

Default:	No
Selection:	Yes or No
Yes	Supervise the network interface module (NIM).
No	Do not supervise the network interface module (NIM).

This item determines whether the NIM is supervised. If the NIM is supervised, disconnecting it from the control panel creates a Trouble SDI 88 Event and the keypad annunciates a trouble tone and displays SERVC SDI 88.



Trouble SDI 88 Reports are always reported using the account number for Area 1.

Base Port Number

Default:	7700
Selection:	0 to 65535

The base port number is the port number of the CoBox™, such as 7700. This is used in the future revision and is not needed at this time.

6.7 Route Group Attempts

This section determines how many times a route group tries the primary destination before trying the backup destination if the primary destination fails. This entry applies to both Phone numbers and IP addresses.

RG# 1 Attempt

Default:	No
Selection:	Yes or No
Yes	This route group tries the primary destination once and, if unsuccessful, tries the backup destination. The control panel still makes a total of ten attempts (five to the primary, five to the backup) before generating a route group Comm Fail Event.
No	This route group tries the primary destination twice and, if unsuccessful, tries the backup destination. The control panel makes a total of ten attempts (six to the primary, four to the backup) before generating a route group Comm Fail Event.

6.8 Miscellaneous**Fire Supv Res Type**

Default:	0
Selection:	0, 1, 2
0	The control panel sends a FIRE TROUBLE RESTORE when a Fire Supervision point restores to normal.
1	The control panel sends a FIRE ALARM RESTORE when a Fire Supervision point restores to normal.
2	The control panel sends a FIRE SUPERVISION RESTORE when a Fire Supervision point restores to normal.

Determines how the control panel sends a Fire Supervision Restoral Event.



The Fire Supv Restore Event is part of Fire Events in Routing. If Fire Supervision Restore Events are needed, simply enable them in Routing.

Enable Protocol Type

Default:	No
Selection:	Yes or No

Not required. Leave at default value.

Enable Anti Replay

Default:	No
Selection:	Yes or No

This feature is used primarily for two purposes:

Anti-Replay: A strategy designed against replay attacks. This feature prevents substituting a control panel or network interface module (NIM) solution for delivering events over a network.

A replay attack occurs when a hacker records a message sent over the network by Device A and replays this message at a later time while pretending to be Device A.



If this function is required, you must also enable the Anti-Replay function in the D6600 Receiver. Refer to the *D6600 Operation and Installation Manual* (P/N: 39964) for more details.

Account Identification: The D6600 Receiver can identify the NetCom accounts by either the IP address or the account number received in the message sent from the control panel. The account number transmitted in the message is always Area 1's account number. Although up to ten digits can be programmed for the account number, only eight digits are sent in the message to the D6600 receiver.

Fire Trouble Resound

Default:	0
Selection:	0, 1, 2
0	Keypads do not re-sound the fire trouble tone.
1	Keypads re-sound the fire trouble tone at 12:00 PM if any Fire point that falls within the scope of a keypad is in an off-normal condition.
2	Keypads re-sound the fire trouble tone at 12:00 AM if any Fire point that falls within the scope of a keypad is in an off-normal condition.

This item determines if a fire trouble condition, previously acknowledged and silenced at a keypad, automatically (locally) re-sounds the fire trouble tone at 12:00 PM, 12:00 AM, or not at all if the point is still in an off-normal state. Events are not generated at the time the re-sound occurs.

Early Ambush Timer

Default:	10 minutes
Selection:	5 to 30 minutes

The programmed time is the maximum value of the Early Ambush Timer. When Early Ambush is set to **Yes** for a specified area (refer to *A# Early Ambush* on page 44) and the area is disarmed, the user has the amount of time programmed here to enter a second code into the keypad.

If a second pass code is not entered within the programmed time, a Duress event is generated based on the first user code. Duress reports must be enabled in Routing in order to be sent to a central station.

Secondary Ambush Code

Default:	Unique
Selection:	Unique or any
Unique	The code used to end the timer must be different from the code used to disarm the area.
Any	The timer can be stopped using a different code, or the same code that disarmed the area.

The Secondary Ambush Code determines whether the same pass code can be used to begin and end the Early Ambush process.

6.9 Cross Point Parameters

This section discusses the requirements necessary to program Cross Point functions.

The Cross Point option reduces false alarms. Points can be programmed so that the control panel needs to see an Alarm condition within a programmed period of time (called Cross Point Time) from at least two points within a Cross Point Group (*Table 41* on page 133) before Cross Point Alarm Events are generated. These points need the Cross Point option enabled in their corresponding point indexes to generate this event.

Cross Point Groups were established in the D9412GV2 and D7412GV2 to support the Cross Point functions. There are 31 Cross Point Groups in the D9412GV2 and ten in the D7412GV2. Each Cross Point Group consists of eight points and is identified by the point numbers in them (for example, Cross Points 1 to 8, Cross Points 9 to 16, and so on). The maximum number of points that can be programmed to meet the Cross Point criteria is two. Point numbers from different Cross Point Groups do not affect each other. Refer to *Table 41* on page 133 for a complete listing of Cross Points comprising each Cross Point Group.

Table 41: Cross Point Ranges Within Groups

Cross Point Group	Point Range		
1	1	to	8
2	9	to	16
3	17	to	24
4	25	to	32
5	33	to	40
6	41	to	48
7	49	to	56
8	57	to	64
9	65	to	72
10	73	to	80
11	81	to	88
12	89	to	96
13	97	to	104
14	105	to	112
15	113	to	120
16	121	to	127
17	129	to	136
18	137	to	144
19	145	to	152
20	153	to	160
21	161	to	168
22	169	to	176
23	177	to	184
24	185	to	192
25	193	to	200
26	201	to	208
27	209	to	216
28	217	to	224
29	225	to	232
30	233	to	240
31	241	to	247

When any Cross Point detects an alarm condition, the control panel starts a timer as programmed in the **Cross Point Time** prompt.

If a second Cross Point within the same Cross Point Group detects an alarm condition, the control panel creates a Cross Point Alarm Event for both points, provided both points activate inside the Cross Point Window.

If a single Cross Point detects an alarm and stays faulted throughout the Cross Point Window, a standard Alarm Report is generated for that point.

Conversely, if a single Cross Point detects an alarm, then restores, and no other conditions occur, an Unverified Event is generated for that point. A second alarm on the first point does not create an Alarm Event but rather an Unverified Event.

Section 2.3 Routing on page 13 determines whether these events are sent to a central station. An Unverified Event does not produce a corresponding Restoral Event.

The Cross Point function applies only to alarm conditions. It does not apply to supervisory or trouble conditions. Points programmed with point response D (Delayed) eventually enter into an alarm condition if the area is not disarmed in time.



Use the Cross Point function on Non-fire points only.

Cross Point Time

Default: 20 seconds

Selection: 5 seconds to 255 seconds

Select the amount of time (in seconds) that points within a Cross Point Group are in alarm before a Cross Point event is generated.

Notes

7.0 RADXAXS

7.1 Door Profile

This programming category is used to:

- Assign an area that also activates the D9210B
- Assign a point to the door
- Program the door state to change the time when the arm state changes
- Allow for the Strike relay to activate upon a fire alarm

Door

Default: 20 sec
Selection: 1 sec to 8 sec

Enter the number of the door you are programming.



The D9412GV2 supports up to eight doors. The D7412GV2 supports two doors.

D# Entry Area

Default: Blank	
Selection: Blank, 1 to 8	
1 to 8	The area assigned to the door controller to which the reader allows access.
Blank	Door controller does not function.

Assign an area to the door controller. This entry allows the D9210B to be polled, activating communication to the control panel. This is also the area a user exits when initiating an REX.



All SDI devices, regardless of area assigned, report to Area 1, Account 1 by default upon SDI failure. If a D9210B becomes disconnected, an SDI Fail ## and a Missing Point ### Event is created.



9210 NOT READY appears at this keypad when you press the [ENTER] key if the D9210B is not programmed with a **D# Entry Area**.

D#CC#Scope

Default: Blank	
Selection: Blank, 1 to 8	
1 to 8	Determines disarming rights. The user's access level and the CC # Scope determines which areas are disarmed.
Blank	Only the area assigned to the D# Entry Area disarms this door.

Enter the keypad number (CC#) which determines the scope of the user ID's disarming rights. Areas disarm on the basis of this keypad's scope and the authority level of the user.

D# Custom Function

Default: 0 (Disabled)	
Selection: 0, 128-143	
0	Custom function disabled.
128-143	The custom function number that executes upon a valid ID, given the appropriate user access level and area arm state.

You can program a custom function to run at the keypad programmed for **CC# Scope**. This custom function activates only for users with an **L## Function Level?** Assignment (refer to 2.11 *User Interface* on page 54) in which a valid ID can execute a custom function during the armed or disarmed state. The user number to which the token is assigned must have an assigned pass code.

If **D# Disarm On Open** is set to **Yes** for the same door, and **L## Function Level?** is set to D or C, the custom function executes when the door is physically opened.



A user's access level and the armed state of the area determine whether the custom function activates. This access level is programmed in the **L## Function Level?** prompt. Refer to 2.11 *User Interface* on page 54.

Table 42 on page 136 shows how this programming affects custom function activation.

Table 42: Effects of Programming on Custom Function Activation

L## Function Level?	Custom Function Activation
M (Armed)	User token activates the custom function assigned to the Door Controller only while the entry area for the Door Controller is Master Armed or Perimeter Armed.
D (Disarmed)	User token activates the custom function assigned to the Door Controller only while the entry area for the Door Controller is disarmed.
C (Armed and Disarmed)	User token activates the custom function assigned to the Door Controller regardless of the armed state of the entry area.
Blank	User token does not run the custom function assigned to the Door Controller.

 A user's security level must have an M, P, or D to operate the custom function.

D# Door Point

Default:	Blank
Selection:	Blank, 1 to 127, 129 to 247
1 to 127, 129 to 247	The point number assigned to this door. Points 128 and 248 are reserved by the control panel for internal use.
Blank	No point number is assigned to this door.

Enter the point number assigned to this door. This point cannot be used for any other point assignments.

 Door points must be programmed as Perimeter points. If a 24-hour point type is required for the Door point, you can use a Perimeter point type with a point response of 9 to C. Also, the debounce count must be set to 4 in Point Assignments.

 When assigning Points 1 to 8 (control panel zones), the end-of-line (EOL) resistors must be removed from the control panel.

Also, do not enable any POPIT points (or OctoPOPIT points) sharing the same point number as the Door point. Failure to do so results in extra point trouble conditions upon reboot.

D# Interlock Point

Default:	Blank
Selection:	Blank, 1 to 127, 129 to 247
1 to 127, 129 to 247	The point number assigned to the Interlock point. Points 128 and 248 are reserved by the control panel for internal use.
Blank	No point number is assigned to the Interlock point.

Enter the interlock point number. This point, when faulted, prevents the door controller from allowing access upon a valid ID read or door request.

Do not assign this point to another Door point. You can assign it to another controller. One Interlock point prevents multiple controllers from activating.

 Door points must be programmed as Perimeter points. If a 24-hour point type is required for the Door point, you can use a Perimeter point type with a Point Response of 9 to C. Also, the debounce count must be set to 4 in Point Assignments.

 The Interlock point is considered in a normal state if it is bypassed, swinger bypassed, or forced armed. This results in normal access even if the door remains open.

D# Auto Door?

Default:	No
Selection:	Yes or No
Yes	When the area assigned in D# Entry Area # is disarmed, the door is in the unlocked state. When that area is armed, the door returns to the locked state.
No	Door state is not affected by the armed state of the area.

Use this program item to automatically unlock the door (latched, shunt, and strike) when the entry area is disarmed. The door re-locks upon Master or Perimeter Arming the area.

 The unlocked state cannot be overridden manually.

 Doors that are activated by Fire Unlock must be returned to normal using the Door Control function on the keypad.

D# Fire Unlock?

Default:	No
Selection:	Yes or No
Yes	Relay activates and shunt is applied for the door contact automatically upon a Fire Alarm.
No	Door remains in its current mode upon a Fire Alarm.

Use this program item to activate the relay for the door strike and shunt the door zone automatically upon a Fire Alarm. This feature overrides a Secure Door state, Locked Door state, Auto Door, and an Interlock Faulted point. The relay activates for all doors with this prompt programmed as **Yes** when a Fire Alarm occurs in any area. Relays that are activated by Fire Unlock can be returned to normal only through the keypad using the Door Control function.

 This unlocks the door regardless of the armed state.

 Each fire alarm that is generated causes a Door Unlocked – Automatic Event.

D# Disarm on Open?

Default:	Yes
Selection:	Yes or No
Yes	The area disarms only after the door is opened for a user with a valid disarm level.
No	The area disarms whether or not the door is opened as soon as a user with a valid disarm level presents a valid token or card.

Use this program item to determine if the door needs to be physically opened before disarming the area upon a valid access request. The user initiating the access request needs access levels that allow disarming with ID.

D# Card Type

Default:	0
Selection:	0 to 3
0	Card format is 26-bit Wiegand.
3	Do not use. Card format is 37-bit fidelity.

This item must be kept to a value of 0 (26 bit Wiegand format).

7.2 Strike Profile

This programming category is used to create a specific door profile for:

- Strike and shunt times.
- Extending strike and shunt times if a door is left open.
- Resetting the strike when the door opens.
- Programming the Interlock point.

Door

Default: 1
Selection: 1 to 8

Enter the door you are programming.

D# Strike Time

Default: 10 seconds	
Selection: 1 second to 240 seconds	
Blank	Strike Time is not programmed for this door.
1 to 240	The strike activates for the amount of time programmed.

Enter the amount of time the door controller toggles the relay output to activate the door strike. When the door strike is activated, the user can open the door. The strike activates for a valid token, RTE, REX, and the keypad CYCLE DOOR? function.

D# Shunt Time

Default: 10 seconds	
Selection: Blank, 1 second to 240 seconds	
Blank	Shunt Time is not programmed for this door.
1 to 240	The shunt activates for the amount of time programmed.

Enter the amount of time that the Door point is shunted to allow a user to open the door. The duration of time should be sufficient so that the opened door does not cause the point to enter into a trouble, alarm, or faulted condition.

D# Buzz Time

Default: 2 seconds	
Selection: Blank, 1 second to 240 seconds	
Blank	Buzz Time is not programmed for this door.
1 to 240	The buzzer sounds for the amount of time programmed.

Enter the amount of time the buzzer output sounds to notify the user that the strike was activated and the door is ready to open. The buzzer stops as soon as the door is opened.



A separate buzzer is required. Many readers have an internal buzzer that is not affected by Buzz Time.

D# Extend Time

Default: 10
Selection: Blank, 1 second to 30 seconds

Enter the amount of time that strike, buzz, and shunt activation is prolonged if a door is left open and the shunt time expires. At the end of the programmed extend time, the buzzer continues to buzz until the door closes. If programmed, the point assigned to the door indicates a trouble, alarm, or fault at the keypad.



The CLOSE DOOR # display on keypad does not activate if no time (blank) is programmed.



Regardless of how the Door point is programmed, the system generates a Trouble Door Left Open Event while the system is disarmed, and an Alarm Door Left Open Event if the system is armed and the door is held open beyond Extend Time. Door Closed - Restoral Events are generated after the door is held open past Extend Time and the door returns to normal.

D# Deact On Open?

Default:	Yes
Selection:	Yes or No
Yes	Strike deactivates when the door is opened after a valid Access Granted request.
No	Strike remains activated for the amount of the programmed strike time whether door is opened or closed.

Determines if the strike deactivates immediately upon physically opening the door.



In order for this function to work, a point needs to be assigned to the door.



To Reduce False Alarms, maintain **D# Deact on Open?** as the default (**Yes**). This helps prevent the door from bouncing open and causing a false alarm.

D# RTE Shunt Only?

Default:	No
Selection:	Yes or No
Yes	Programmed shunt time activates so door can be manually opened.
No	RTE automatically activates the programmed strike and shunt time.

Use this program item to disable the strike, but still activate the programmed shunt time at a Request to Exit (REX) area.



Use this parameter when a user can open a door manually without relying on a token or card to activate the strike (such as with a push bar).



When **RTE Shunt Only** is Yes, RTE Events are not logged, reported, or printed.

D# REXShunt Only?

Default:	No
Selection:	Yes or No
Yes	Programmed shunt time activates so the door can be manually opened.
No	REX automatically activates the programmed strike and shunt time.

Use this program item to disable the door strike, but activate the programmed **D# Shunt Time** upon a request to exit (REX) from an area.



Use this parameter when a user can open a door manually without relying on a token or card to activate the strike (such as with a push bar).



When **REXShunt Only** is Yes, REX Events are not logged, reported, or printed.

7.3 Event Profile

This programming category is used to determine if events are created for:

- Access Granted and Access Denied
- Door Requests
- Door state changes due to manual (keypad) or automatic scheduled or armed state changes (skeds/hold open on disarm, normal on armed) operation.

Door #

Default:	1
Selection:	1 to 8

Enter the door you plan to program.



RTE Events require **Access Granted** to be programmed as **Yes**.

D# Access Granted?

Default: No	
Selection: Yes or No	
Yes	Access Events from this door controller are sent to the control panel for processing.
No	Access Events from this door controller are not sent to the control panel for processing.

This program item determines if Access Granted and Door Request Events are sent to the control panel for processing memory, printing, and remote reporting.

<input checked="" type="checkbox"/>	<p>A successful Access Event can be started by a(n):</p> <ul style="list-style-type: none"> Valid user ID Valid door state changed at the keypad. Automatically scheduled or armed state change that holds a door open RTE or REX.
-------------------------------------	--

D# No Entry?

Default: No	
Selection: Yes or No	
Yes	Access Denied Events from this door controller are sent to the control panel for processing.
No	Access Denied Events from this door controller are not sent to the control panel for processing.

This program item determines if No Entry Events are sent to the control panel for processing memory, printing, and remote reporting.

<input checked="" type="checkbox"/>	<p>A No Entry Event can be caused by:</p> <ul style="list-style-type: none"> Invalid or unknown user ID, interlock or secured door, or incorrect authority level RTE or REX for door in interlock or secured door.
-------------------------------------	--

D# Enter Request?

Default: No	
Selection: Yes or No	
Yes	A Door RTE Event from this door controller is sent to the control panel for processing.
No	A Door RTE Event from this door controller is not sent to the control panel for processing.

This program item determines if RTE Events are sent to the control panel for processing memory, printing, and remote reporting.

<input checked="" type="checkbox"/>	<p>RTE Events require D# Access Granted to be programmed as Yes.</p>
-------------------------------------	--

D# Exit Request?

Default: No	
Selection: Yes or No	
Yes	A Door RTE Event from this door controller is sent to the control panel for processing.
No	A Door RTE Event from this door controller is not sent to the control panel for processing.

This program item determines if REX Events are sent to the control panel for processing memory, printing, and remote reporting.

<input checked="" type="checkbox"/>	<p>REX Events require D# Access Granted to be programmed as Yes.</p>
-------------------------------------	--

Programming Prompts Directory

GV2MAIN	9	AC Fail Time	25
Phone	9	AC Fail/Res Rpt.....	26
Phone 1	9	AC Tag Along	26
Phone 2	9	AC/Battery Buzz	26
Phone 3	9	Bat Fail/Res Rpt	26
Phone 4	9	Printer Parameters	27
Phone Parameters	10	Printer Address	27
Modem Format	10	P### Area Assign.....	95
Point/User Flag.....	10	P## Supervised	27
DTMF Dialing	11	P## Scope.....	27
Phone Supv Time	12	P## A1 [through A8] in Scope	27
Alarm On Fail.....	12	P## Fire Events.....	28
Buzz on Fail.....	12	P## Burglar Event	28
Two Phone Lines.....	12	P## Access Event	28
BFSK Duress Code.....	12	P## User Event.....	28
Expand Test Rpt.....	13	P## Test Event.....	28
Routing	13	P## Diag Event.....	28
<i>Dialing Attempts</i>	14	P## Auto Functions Event	28
Route #	14	P## RPS Event	28
R# Primary Device	14	P## Relay Event.....	28
R# Backup Device	15	P## Point Event.....	28
View Events?.....	15	P## Usr Chng Evt	28
Fire Reports.....	15	RPS Parameters	28
Burglar Reports.....	16	<i>RPS Callback Reports</i>	29
User Reports	16	RPS Passcode	29
Test Reports	12	Log % Full	29
Diag Reports	17	RPS Call Back.....	30
Relay Reports	18	RPS Line Monitor	30
AutoFunc Reports	18	Answer Armed.....	30
RPS Reports.....	19	Answer Disarmed	30
Point Reports	19	RPS Ph.....	31
User Chng Reports.....	20	Miscellaneous	31
Access Reports.....	20	Duress Type	31
Enhanced Routing	21	Cancel Report.....	32
<i>Programming a Duplicate Report</i>	21	Area Parameters	32
RG# Primary SDI	22	<i>Area Parameters</i>	32
RG# Backup SDI	22	Area.....	32
RG# Primary Pager	22	A# Area On.....	32
Power Supervision	25	A# Acct Number.....	32

A# FA Bypass Max.....	33	CC# Entry Tone	48
A# Delay Res.....	33	CC# Exit Tone.....	49
A# Exit Tone	34	CC# Arm Now Warn.....	49
A# Exit Dly Time	34	CC# Close Door	49
A# Auto Watch	34	CC# EnhancCmdCtr.....	49
A# Verify Time	34	CC# Passcode Follows Scope.....	40
A# Duress Enable	35	CC# Menu Key Lock.....	50
A# Area Type.....	36	<i>Area Text</i>	50
<i>Bell Parameters</i>	37	Area.....	51
Area.....	38	Area# Is On.....	51
A# Fire Time	38	Area# Not Ready	51
A# Fire Pat.....	38	Area# Is Off.....	51
A# Burg Time.....	38	Area# Acct Is On.....	51
A# Burg Pat	38	<i>Custom Function</i>	52
A# Single Ring	39	Custom Function	52
A# Bell Test	39	CF### Text.....	52
<i>Open/Close Options</i>	39	CF### Key Strokes.....	52
Area.....	40	User Interface	54
A# Acct O/C	40	<i>Keypad Selections</i>	54
A# Area O/C.....	41	Master Arm Delay.....	55
A# Disable O/C in Window.....	41	Mstr Arm Inst	55
A# Auto Close.....	41	Perim Instant.....	55
A# Fail to Open	41	Perim Delay	55
A# Fail to Close.....	42	Watch Mode	56
A# Restrictd O/C.....	42	Perim Partial	56
A# Perimeter O/C	43	View Area Stat.....	56
A# Latest Close Time	40	View Memory.....	56
<i>Arming Features</i>	43	View Pt Status.....	56
Two Man Rule.....	40	Walk Test	56
A# Early Ambush	44	Fire Test.....	57
Keypad (Command Center)	45	Send Report	57
<i>Keypad (Command Center) Assignment</i>	45	<i>Access Control Functions</i>	57
Cmd Center	45	Door Control	57
CC# Supervised	46	Access Ctl Level	57
CC# Area Assign	46	Chg Display	57
CC# Scope	46	Chg Time/Date.....	57
CC# A1[through A8] in Scope.....	47	Chg Passcode	58
CC# Entr Key Rly	47	Add User	58
CC# Entr Cycl Dr.....	47	Del User	58
CC# Assign Door.....	48	Extend Close.....	58
CC# Trouble Tone	48	View Log.....	58

Print Log.....	58	L## View Log.....	66
User Cmd 7.....	58	L## Print Log.....	66
User Cmd 9.....	59	L## User Cmd 7.....	66
Bypass a Pt.....	59	L## User Cmd 9.....	66
Unbypass a Pt.....	59	L## Bypass a Pt.....	66
Reset Sensors.....	59	L## Unbypass a Pt.....	66
Change Relay.....	59	L## Reset Sensors.....	66
Remote Program.....	59	L## Change Relay.....	67
Move to Area.....	60	L## Remote Program.....	67
Display Rev.....	60	L## Move to Area.....	67
Service Walk.....	60	L## Display Rev.....	67
Default Text.....	60	L## Service Walk.....	67
Change Skeds.....	60	L## Default Text.....	68
#36 Invisible Walk Test.....	60	L## Change Skeds.....	68
C Function 128 [through 143].....	61	L## Function Level.....	70
<i>Authority Level Selections.....</i>	<i>61</i>	<i>Custom Functions.....</i>	<i>68</i>
Authority Level.....	61	L## C Function 128 [through 143].....	68
L## Disarm.....	61	L## Force Arm.....	68
L## Master Arm Delay.....	62	L## Area O/C.....	68
Mstr Arm Inst.....	62	L## Restricted O/C.....	68
L## Perim Instant.....	62	L## Perimeter O/C.....	69
L## Perim Delay.....	62	L## Send Duress.....	69
L## Watch Mode.....	62	L## Passcode Arm.....	69
L## Perim Partial.....	62	L## Passcode Disarm.....	69
L## View Area Stat.....	62	L## Security Level.....	69
L## View Memory.....	63	L## Disarm Level.....	69
L## View Pt Status.....	63	L## Function Level.....	70
L## Walk Test.....	63	Function List.....	70
L## Fire Test.....	63	Menu Item.....	70
L## Send Report.....	64	M## Function.....	70
L## Door Control.....	64	M## CC Address 1 [through 8].....	71
L## Cycle Door.....	64	Relay Parameters.....	71
L## Unlock Door.....	64	Area Relays.....	72
L## Secure Door.....	64	Area.....	72
L## Access Ctl Lvl.....	65	A# Alarm Bell.....	72
L## Chg Display.....	65	A# Fire Bell.....	72
L## Chg Time/Date.....	65	A# Reset Sensors.....	72
L## Chg Passcode.....	65	A# Fail to Close.....	72
L## Add User.....	65	A# Force Armed.....	73
L## Del User.....	66	A# Watch Mode.....	73
L## Extend Close.....	66	A# Area Armed.....	73

A# Area Fault	73	P## Watch Point.....	89
A# Duress Relay	73	P## RlyResp Type	90
A# Perim Fault	73	P## Disp as Dvc	90
A# Silent Alarm	73	P## Local While Disarmed	90
<i>Panel-Wide Relays</i>	74	P## Local While Armed.....	91
AC Failure	74	P## Disable Rst	91
Battery Trouble.....	74	P## FA Retrnable.....	91
Phone Fail.....	74	P## BP Retrnable	91
Comm Fail.....	75	P## Bypassable	92
Log % Full	75	P## Swinger Byp.....	92
Summary Fire	75	P## Report Bypass at Occurrence	92
Summary Alarm	75	P## Defer BP Report	93
Summary Fire Tbl	75	P## Cross Point	93
Summary SupFire.....	75	P## Fire Point	93
Summary Trouble	75	P## Alarm Verify	94
Summary SupBurg	75	P## Resettable	94
RADXUSR1/RADXUSR2	77	Point Assignments	94
Pass Code or Token Worksheet	77	Point Number	94
<i>Reporting and Logging</i>	77	P### Point Index	95
User ###	78	P### Area Assign.....	95
U### Passcode	79	P### Debounce.....	95
U### User Group	79	P### BFSK/Relay	96
U### Area 1 [through Area 8] Auth....	79	P### Point Text	96
U### Name	79	COMMAND 7 and COMMAND 9	97
U### Mstr Site	80	CMD7 Point Index	97
U### Mstr Crd Data	80	CMD7 BFSK/Relay	97
U### SU1 through SU3 Site	80	CMD7 Point Text.....	97
U### SU1 through SU3 C/D.....	80	CMD9 Point Index	97
RADXPNTS	81	CMD9 BFSK/Relay	97
Point Index	81	CMD9 Point Text.....	97
Point Index.....	81	RADXSKEDE	99
P## Type	81	Windows	99
<i>Point Responses</i>	85	<i>Opening and Closing</i>	99
P## Pt Response	86	Window	99
P## Entry Delay	87	W# Sunday	99
P## Ent Tone Off	87	W# Monday	100
P## Silent Bell.....	87	W# Tuesday	100
P## Ring Til Rst	87	W# Wednesday.....	100
P## Audible After 2 Failures.....	88	W# Thursday.....	100
P## Invisible Pt.....	88	W# Friday	100
P## Buzz On Fault	89	W# Saturday.....	100

W# Open Early Begin	100	S## Custom Func	112
W# Open Window Start	101	S## Cmd Center 1[through 8]	113
W# Open Window Stop	101	S## Access Ctl Level #	113
W# Close Early Begin	102	S## Access Ctl Level#	113
W# Close Window Start	103	S## Door 1 [through 8]	114
W# Close Window Stop	103	S## Door 1 [through 8]	114
W# Xept Holiday	104	S## Door 1 [through 8]	114
W# Holiday 1	104	S## Door 1 [through 8]	115
W# Holiday 2	104	S## Door 1 [through 8]	115
W# Holiday 3	104	S## Door 1 [through 8]	115
W# Holiday 4	104	S## Time	116
W# Area 1 [through 8]	104	S## Date	116
<i>User Group Windows</i>	<i>106</i>	S## Sunday	116
User Windows #	106	S## Monday	116
UW# User Group	106	S## Tuesday	116
UW# Sunday	107	S## Wednesday	116
UW# Monday	107	S## Thursday	116
UW# Tuesday	107	S## Friday	116
UW# Wednesday	107	S## Saturday	116
UW# Thursday	107	S## Xept Holiday	117
UW# Friday	107	S## Holiday 1	117
UW# Saturday	107	S## Holiday 2	117
UW# Group Enable	107	S## Holiday 3	117
UW# Group Disable	107	S## Holiday 4	117
UW# Xept Holiday	108	Holiday Indexes	117
UW# Holiday 1 [through 4]	108	<i>Add/Change/Delete</i>	<i>117</i>
Skeds	108	Date	117
Sked Number	108	Holiday Index 1	118
S## TimeEdit	108	Holiday Index 2	118
S## Function Code	109	Holiday Index 3	118
S## Area 1[through 8]	109	Holiday Index 4	118
S## Area 1[through 8]	109	<i>View Holidays</i>	<i>118</i>
S## Point Number	109	Index 1 Days	118
S## Point Number	109	Index 2 Days	118
S## Area 1[through 8]	110	Index 3 Days	118
S## Relay Number	110	Index 4 Days	118
S## Relay Number	110	GV2AUX	119
S## Defer Test	111	SDI Automation	119
S## Hourly Report	111	Enable SDI Auto	119
S## Defer Status	111	Baud Rate	119
S## Cmd Center	112	Parity/Stop	120

9133 Supervision	120	Enable Protocol Type	131
RTS Control.....	120	Enable Anti Replay.....	131
DTR Control.....	120	Fire Trouble Resound.....	132
Status Rate.....	120	Early Ambush Timer	132
SDI RPS Parameters	121	Secondary Ambush Code.....	132
<i>User Interface Modifications for COMMAND 43121</i>		Cross Point Parameters.....	132
Enable SDI RPS	121	Cross Point Time.....	133
Call Back Enabled.....	121	RADXAXS	135
RPS IP Address 1	122	Door Profile	135
RPS IP Address 2	122	Door #	135
RPS IP Address 3	122	D# Entry Area #.....	135
RPS IP Address 4	122	D#CC#Scope	135
<i>Using an External Modem.....</i>	<i>123</i>	D# Custom Function	135
Enable Ext Modem	126	D# Door Point.....	136
Answer Armed.....	126	D# Interlock Point	136
Answer Disarmed.....	126	D# Auto Door?	137
RPS Line Monitor	126	D# Fire Unlock?.....	137
Seize Relay	126	D# Disarm on Open?	137
Modem Init String.....	126	D# Card Type	137
RPS Dial String.....	126	Strike Profile	138
Programming Path Numbers and IP Addresses for Enhanced Communications.....	127	Door #	138
Enhanced Comm.....	127	D# Strike Time.....	138
Path # IP Add1	127	D# Shunt Time.....	138
Path # IP Add2.....	127	D# Buzz Time	138
Path # IP Add3.....	127	D# Extend Time	138
Path # IP Add4.....	127	D# Deact On Open?	139
Path # Poll Rate.....	128	D# RTE Shunt Only?.....	139
Path # Ack Wait.....	129	D# REXShunt Only?.....	139
Path # Retry Count.....	129	Event Profile.....	139
SDI RPS/Enhanced Communications Configuration	130	Door #	139
Baud Rate	130	D# Access Granted?	140
Parity/Stop.....	130	D# No Entry?.....	140
RTS Control.....	130	D# Enter Request?.....	140
DTR Control.....	130	D# Exit Request?	140
9133 Supervision	131		
Base Port Number	131		
<i>Route Group Attempts.....</i>	<i>131</i>		
RG# 1 Attempt.....	131		
Miscellaneous	131		
Fire Supv Res Type.....	131		

Notes

Bosch Security Systems
130 Perinton Parkway
Fairport, NY 14450-9199
Customer Service: (800) 289-0096
Technical Support: (888) 886-6189

© 2005 Bosch Security Systems
F001U003636B



BOSCH