

Linear SECURITY

DVS 2400

SUPERVISED WIRELESS SECURITY CONSOLE

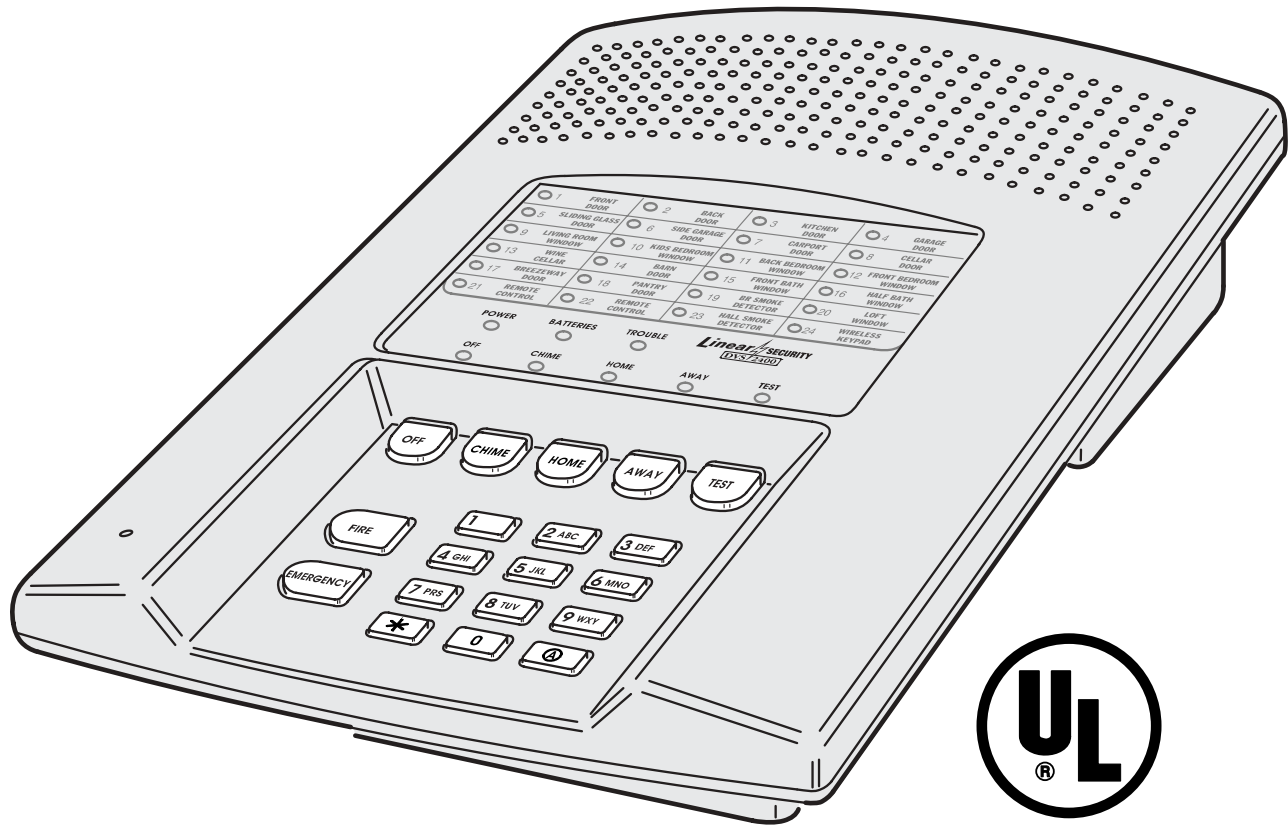

Installation & Programming Instructions

Linear[®]

(760) 438-7000 • FAX (760) 438-7043
 USA & Canada (800) 421-1587 & (800) 392-0123
 Toll Free FAX (800) 468-1340
www.linearcorp.com

INTRODUCTION

CONGRATULATIONS for selecting Linear's DVS-2400 Security System. The DVS-2400 Console incorporates many advanced and sophisticated features. The system can be expanded and customized to fit the installation's specific needs. The DVS-2400 Console and its accessories are designed and manufactured by the oldest wireless security company in North America. You can look ahead to many years of reliable service with this Console and its accessories.

Many insurance companies offer discounts on homeowners and renters policies when a security system is installed. Discount credits vary with different companies and generally increase in savings with an increase in the level of protection. Inform the user to ask their insurance agent about savings available.

The DVS-2400 Console is UL Listed. For a UL smoke alarm system, there must be at least one smoke detector programmed into the Console to meet National Fire Protection Association (NFPA) Rule 72 Chapter 2 and UL 217 requirements. Many insurance companies require you to meet these requirements to qualify for a discount. Only use the Model DXS-72 smoke detector with this Console for a UL smoke alarm system.

NOTE: *Some cities and municipalities may require an alarm system permit. Check with your local authorities before installing this system.*

In this manual, the bullets preceding the text help to define the step. For example:

- ◆ This symbol indicates a feature.
- This symbol indicates an action to perform and provides a box to check when the action is completed.
- ※ This symbol is for lit indications or system sounds.
- 📌 **This symbol is for important notes.**



UL Listed as a Single Station Smoke Detector Accessory, also suitable as a Household Burglar-Alarm System Control Unit.
UL Category CCN UTGT & NBSX.

TABLE OF CONTENTS

1. THE DVS-2400 SECURITY SYSTEM	2	12. ADVANCED PROGRAMMING	25
CONSOLE	2	SETUP MODE	25
DOOR/WINDOW SENSORS	3	CHANGING A SENSORS SUPERVISION	26
WIRELESS KEYPAD	3	CHANGING A SENSORS RESTORE REQUIREMENTS	26
SMOKE DETECTORS	3	ENTRY DELAY TIME	26
REMOTE CONTROLS	3	EXIT DELAY TIME	26
PANIC BUTTONS	3	BURGLARY SIREN TIME	26
BILL TRAP	3	EMERGENCY SIREN TIME	26
PASSIVE INFRARED MOTION DETECTOR	3	FIRE SIREN TIME	27
GLASS BREAK DETECTOR	3	AUTOMATION OUTPUT TIME	27
2. SECURITY SYSTEM FLOOR PLAN	4	REMOTE CONTROL ARMING LEVEL	27
EXAMPLE SYSTEM	4	REMOTE CONTROL DISARMING LEVEL	27
DESIGN THE INSTALLATION	4	ENTRY DELAY BEEPS	27
3. TYPICAL SYSTEM SENSORS	5	EXIT DELAY BEEPS	27
DOOR/WINDOW SENSOR	5	SILENT BURGLARY ALARMS	28
WIRELESS KEYPAD	5	SILENT EMERGENCY ALARMS	28
4. CONSOLE FEATURES	6	DISABLING QUICK ARMING	28
5. CONSOLE INSTALLATION	8	AUTOMATIC RESTORAL OF BYPASSED SENSORS	28
CONSOLE LOCATION	8	AUTOMATIC BYPASSING OF OPEN SENSORS	28
CASE LOCKING SCREW	8	AUTOMATION OUTPUT MODE DURING ALARM	29
WALL MOUNTING	8	AUTOMATION ACTIVATION TONE	29
EXTERNAL CONSOLE SPEAKER CONNECTION (OPTIONAL)	9	REMOTE CONTROL ARM/DISARM CHIRP	29
EXTERNAL ALARM SIREN CONNECTION (OPTIONAL)	9	AUTOMATION OUTPUT FLASHES DURING AND AFTER ALARM	29
TELEPHONE LINE CONNECTION (OPTIONAL)	10	AUTOMATION OUTPUT ON DURING ALARM	29
AUTOMATION OUTPUT CONNECTION (OPTIONAL)	10	AUTOMATION OUTPUT WHILE ARMED	30
CONSOLE POWER CONNECTION	11	AUTOMATION OUTPUT DURING EXIT/ENTRY DELAYS	30
BACKUP BATTERY INSTALLATION (OPTIONAL)	11	AUTOMATION OUTPUT POLARITY	30
6. BASIC CONSOLE PROGRAMMING	12	REMOTE ACCESS PASSWORD	30
CREATE THE MASTER USER CODE	12	DURESS CODE	30
PROGRAM THE SENSORS INTO THE CONSOLE'S MEMORY	12	MASTER USER CODE	30
PROGRAMMING DIFFERENT SENSOR TYPES	13	ADDITIONAL USER CODES	31
7. BASIC SENSOR INSTALLATION	14	REMOVING USER CODES	31
DXS-10 WIRELESS KEYPAD	14	CONSOLE MASTER RESET	31
DXS-31 DOOR/WINDOW SENSORS	15	13. COMMUNICATOR PROGRAMMING	32
TEST SENSORS	15	SETUP MODE	32
8. CUSTOMIZING THE CONSOLE	16	GENERAL COMMUNICATOR OPTIONS	33
LABELING THE SENSORS	16	COMMUNICATOR ENABLE	33
9. CONSOLE OPERATING MODES	17	2-WAY AUDIO	33
OFF MODE	17	VOICE RESPONSE	33
CHIME MODE	17	REMOTE LOCKOUT	33
HOME MODE	18	CALL LIMITER	34
SECURE EXIT	18	DIALING DELAY	34
HOME INSTANT MODE	18	DIALING METHOD	34
MANUAL BYPASSING OF SENSORS	18	COMMUNICATOR REPORTING OPTIONS	35
AWAY MODE	19	REPORTING FORMAT	35
MANUAL BYPASSING OF SENSORS	19	CALL ROUTING	35
TEST MODE	20	ACCOUNT NUMBER	36
10. SYSTEM TROUBLE INDICATIONS	21	PRIMARY TELEPHONE NUMBER	36
CONSOLE LOW BATTERY	21	SECONDARY TELEPHONE NUMBER	36
SENSOR LOW BATTERIES	21	SUPERVISORY/PAGER TELEPHONE NUMBER	36
SENSOR RADIO TROUBLE	21	REPORT CONSOLE TROUBLE	37
11. CUSTOMIZING THE SYSTEM	22	REPORT FORCE ARMING	37
ADDING SENSORS TO THE SYSTEM	22	OPENING AND CLOSING REPORTS	37
REMOVING SENSORS FROM THE SYSTEM	22	POINT ID REPORTING	37
MAKING A SENSOR A 24-HOUR DOOR CHIME	23	COMMUNICATOR REPORTING CODES	38
MAKING A SENSOR INTERIOR	23	GENERAL REPORTING CODES	38
MAKING A SENSOR ACTIVATE A DIFFERENT ZONE	24	SYSTEM REPORTING CODES	38
		FORCE ARMING REPORTING CODE	39
		DURESS REPORTING CODE	39
		4 BY 2 FORMAT POINT ID REPORTING CODES	40
		4 BY 2 FORMAT POINT ID ALARM REPORT CODES	40
		4 BY 2 FORMAT POINT ID TROUBLE REPORT CODES	40
		IMPORTANT INFORMATION	42
		LINEAR LIMITED WARRANTY	42
		WIRELESS PRODUCT NOTICE	42
		FCC NOTICE	42
		FCC TELEPHONE RULES AND REGULATIONS	42
		FIRE EVACUATION PLANNING	42
		INDUSTRY CANADA NOTICES	42

1. THE DVS-2400 SECURITY SYSTEM

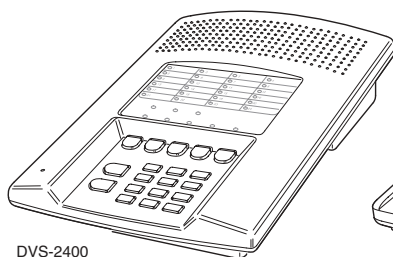

DVS-2400
CONSOLE



DXS-10
WIRELESS
KEYPAD

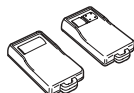

DXT-41 & DXT-42
REMOTES



DXT-21 & DXT-23
REMOTES †



DXT-61
REMOTE †

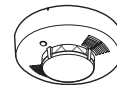

DXS-72
SMOKE DETECTOR



DXS-31
DOOR/WINDOW
SENSOR



DXS-32
DOOR/WINDOW
SENSOR



DXS-81
BILL TRAP †



DXS-54
PIR



DXS-91 GLASS
BREAK DETECTOR †

† NOTE: These accessories
are not listed by UL.

CONSOLE

The DVS-2400 Console is the heart of the system. It monitors all of the system's wireless sensors and controls the alarm sirens.

The Console constantly monitors the condition of the system's sensors, displaying which protected doors and windows are open or closed. If an alarm occurs, the Console displays which sensor(s) caused it. When a sensor has a low battery, the Console displays which sensor needs a new battery. Sensors that send hourly status transmissions keep the Console informed of their operating condition.

Up to eight different custom user codes can be used to operate the system. For security, a user code must be entered to disarm (turn off) the system. The system can be armed (turned on) by entering a user code, or with the unique "Quick Arm" feature. The five restricted user codes and the special page alert user code can only arm and disarm the system, no programming changes are allowed. The master user code is allowed to program the Console, and a duress code can be selected for emergency disarming of the system with a duress report to the Central Station. The page alert user code can dial a pager number to inform the pager wearer when the Console is disarmed.

The Console's memory will retain the user codes and all of the system's programming, even during a total power loss. An optional backup battery can be installed to power the system during short power failures.

The built-in digital communicator connects the Console to a Central Alarm Monitoring Station through the telephone. With a monitored system, the central station can dispatch authorities in case of burglary, fire or other emergency. The central station can also call family, friends, neighbors, or anyone else designated on a custom call list.

Each sensor can report directly to the Central Station using the digital communicator's Point ID feature. If a sensor triggers an alarm or experiences supervisory trouble, a unique report code can be sent for immediate identification of the event.

The optional Models VB-2 or VB-3 digital voice synthesis modules can be installed in the Console. The VB-2 module provides three exciting features: 2-way audio monitoring

capability at the Central Station through the communicator, local human voice prompts from the Console's speaker, and voice prompted remote system control using in-house or off-site pushbutton telephones. The economy Model VB-3 is the same as the VB-2 without 2-way Central Station audio capability.

The Console has 24-hour capabilities that are always ready to operate, even when the Console is disarmed. They can be triggered by buttons on the Console, the Wireless Keypad, portable remote controls and smoke detectors. Pressing the [EMERGENCY] or [FIRE] button for two seconds will cause an immediate siren and call the central station. **IMPORTANT: For personal emergency use only. Not for use as a UL Listed Medical Alert System.**

The Console's Environmental Zone is a 24-hour zone that can be triggered with sensors connected to devices such as water flow detectors, over/under temperature sensors, flood sensors, toxic gas detectors, etc. The Environmental Zone activates the chime annunciator without sounding the siren. The Environmental Zone does not send communicator reports.

An Automation Output in the Console provides an easy way to connect external devices to the Console. The output is fully programmable to activate on a variety of conditions, such as when the system is armed, during alarms, and during exit/entry delays. The Automation Output can connect to lighting control modules, relays, noisemakers, and indicators. The Console's and wireless keypad's (A) key and transmitters can control the Automation Output.

The Console can be programmed locally using its own keypad or remotely, over the telephone, using Linear's Model RA-2400 Remote Access software program. The RA-2400 upload/download program is a Windows™ application that runs on a personal computer and communicates with the Console through a modem, connected directly to the Console or through the telephone line.

A total of 24 sensors of the types listed on the next page can be used with each DVS-2400 Console. Each burglary sensor can trigger the siren (and report to the Central Station) once per arming cycle. 24-hour sensors have unlimited alarm and reporting capacity.

DOOR/WINDOW SENSORS

The DXS-31 & DXS-32 sensors monitor doors and windows. They send radio signals to the Console. One type of signal is sent when the door or window is opened, and a different type of signal is sent when the door or window is closed. If the Console is armed, a sensor can trigger the Console's burglary siren when its door or window is opened. The sensors are supervised, and send hourly status reports and monitors its battery condition.



WIRELESS KEYPAD

The DXS-10 wireless keypad is used to control the Console remotely. It can be placed in a convenient spot so the user doesn't have to go to the Console to control the system. The wireless keypad can also trigger the emergency or fire siren and actuate the Automation Output. Pressing the [*] key will cause the Console to sound beeps corresponding to the current operating mode. The DXS-10 is supervised, it sends hourly status reports and monitors its battery condition. **IMPORTANT: For personal emergency use only. Not for use as a UL Listed Medical Alert System.**



SMOKE DETECTORS

The DXS-72 is a high quality smoke detector with a built-in radio transmitter. As soon as smoke is detected, the unit will sound its local noisemaker. Then, 20 seconds after the local noisemaker sounds, the transmitter sends an alarm signal to the Console. The alarm signal will be repeated every 20 seconds as long as smoke is still present. A restoral signal will be sent when the smoke detection chamber clears. The DXS-72 is supervised, it sends hourly status reports and monitors battery condition.

NOTE: A Model DXS-72 Smoke Detector is required to create a UL Listed smoke alarm system. See Page 22 for details on adding a smoke detector sensor to the system.

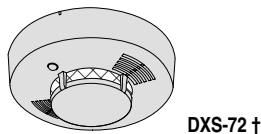

REMOTE CONTROLS

The DXT-41, DXT-61 single-button and DXT-23, DXT-42 multi-button remote controls can be used to remotely arm and disarm the Console. The DXT-42's left button will arm and the right button will disarm the Console. Pressing both buttons simultaneously will trigger the emergency siren. Alternately, the Console can be programmed to respond to the DXT-42 by arming and disarming with the left button and activating the automation output with the right button. These transmitters can also be programmed to activate various other Console zones. These transmitters are **not** supervised.

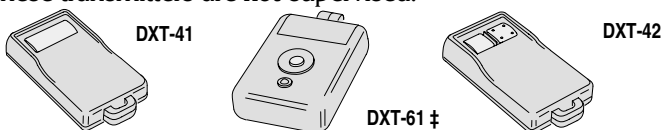

‡ **NOTE: These accessories not listed by UL.**

PANIC BUTTONS

The DXT-21 and DXT-23 transmitters can be used as portable "panic buttons". Pressing the front or top button on the DXT-21 at any time will trigger the emergency siren. Pressing **both** front buttons **simultaneously** on the DXT-23 at any time will trigger the emergency siren. Both transmitters can be programmed to activate various other Console zones. These transmitters are **not** supervised.

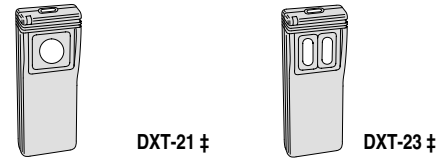

BILL TRAP

The DXS-81 bill trap can be used with the Console in non-UL small commercial hold-up installations. The unit is concealed in a cash drawer under a stack of currency, with a single "bait" bill secured in its money clip. During a hold-up, the cashier removes the stack of currency along with the "bait" bill. When a "bait" bill is removed, the transmitter sends a signal to the Console. Four additional signals are sent within the first minute after the "bait" bill is removed. When the "bait" bill is replaced, a restore signal is sent. The DXS-81 is supervised, it can send hourly status reports (optional) and monitors its battery condition.

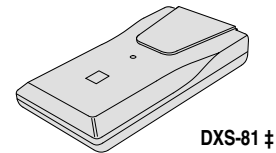

PASSIVE INFRARED MOTION DETECTOR

The DXS-54 is a passive infrared (PIR) motion detector with a built-in radio transmitter. The PIR detects motion in its detection pattern by measuring the infrared emission levels of objects that it "sees". If the infrared levels change quickly, as when a person moves across the detection pattern, the PIR will recognize the change as an intrusion and send an alarm signal to the Console. An alarm will be triggered if the Console is in the Away Mode. The DXS-54 is supervised, it sends hourly status reports and monitors its battery condition.

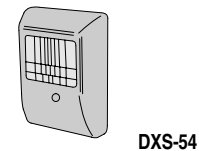

GLASS BREAK DETECTOR

The DXS-91 is a glass break detector with an audio sound discriminator and a built-in radio transmitter. The unit "listens" for the sound of breaking glass. When glass breakage is detected, the unit sends an alarm signal to the Console. The DXS-91 is supervised, it sends hourly status reports and monitors its battery condition.

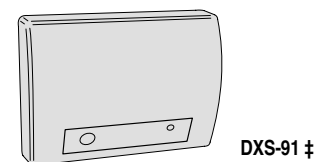

2. SECURITY SYSTEM FLOOR PLAN

EXAMPLE SYSTEM

- ◆ The example shows a typical DVS-2400 system.
- ◆ Any or all of the accessories shown can be used.
- ◆ A total of 24 sensors (including keypads) can be used with each Console.

DESIGN THE INSTALLATION

- Create a floor plan of the installation.
- Consider the security needs of the premises.
- Determine which doors and windows are vulnerable to intrusion.
- Figure which interior areas an intruder might go to if unlawful entrance is gained.
- Indicate locations for door/window sensors, interior motion detectors, keypads, glass break detectors and external siren speakers.
- Decide on a centralized location for the security Console.

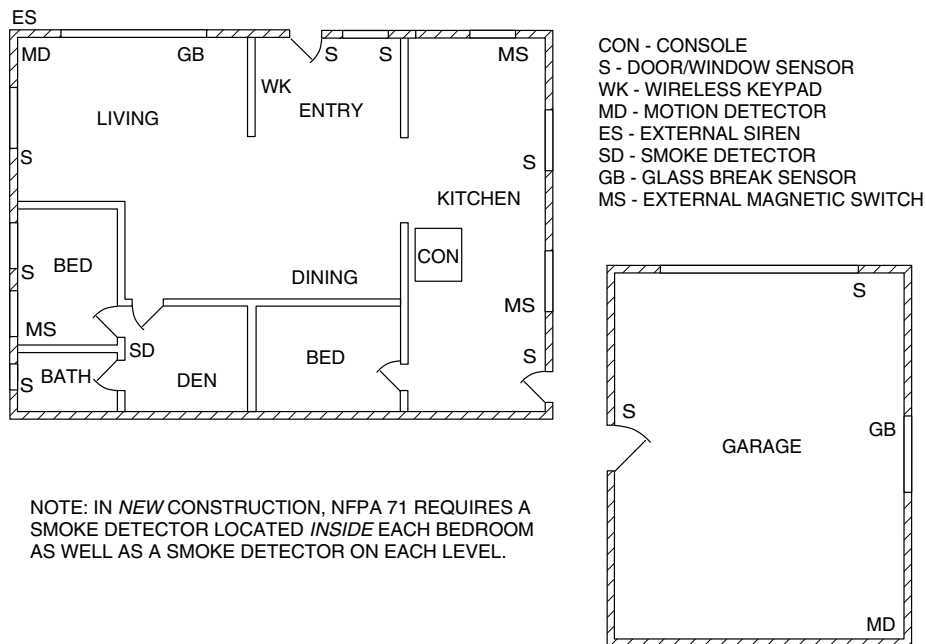

Example Residential Security System Floor Plan

3. TYPICAL SYSTEM SENSORS

DOOR/WINDOW SENSOR

- ◆ Sensor mounts on door or window with adjacent magnet.
- ◆ Opening door or window moves magnet away, triggering sensor.
- ◆ Pressing the case causes sensor to send a test signal.
- ◆ Jumper inside for INSTANT or DELAYED alarm setting.
- ◆ Press the case for testing, the red transmit light shows that battery is in good condition.
- ◆ Internal lithium batteries are monitored by the Console.
- ◆ Sends hourly status reports to the Console.
- ◆ Up to 3 years battery life (depends on frequency of activation). (UL tested for 1 year minimum.)
- ◆ Sensor contains internal terminals for connection to glass break detector and external switches.

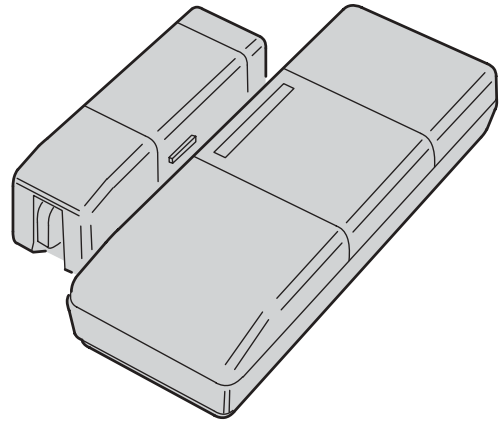

WIRELESS KEYPAD

- ◆ For controlling the system without having to go to the Console.
- ◆ Emergency and fire alarm can be triggered from wireless keypad at any time.
- 🔧 **UL NOTE: For personal emergency use only. Not for use as a UL Listed Medical Alert System.**
- ◆ Green operation light.
- ◆ Internal 9-volt battery is monitored by the Console.
- ◆ Keypad's beeper will buzz during transmissions when the battery is low.
- ◆ Up to 3 years battery life (depends on frequency of activation). (UL tested for 1 year minimum.)
- ◆ Sends hourly status reports to the Console.
- ◆ Press the **[(A)]** key to activate the automation output.
- ◆ Pressing **[*]** clears the keypad.
- ◆ Holding **[*]** for two seconds sounds the mode beeps from the Console.
 - ✓ Off Mode: 1 "Gong"
 - ✓ Chime Mode: 1 "Gong" & 1 "Beep".
 - ✓ Home Mode: 1 "Gong" & 2 "Beeps".
 - ✓ Away Mode: 1 "Gong" & 3 "Beeps".
 - ✓ Test Mode: 1 "Bing" & 4 "Beeps".

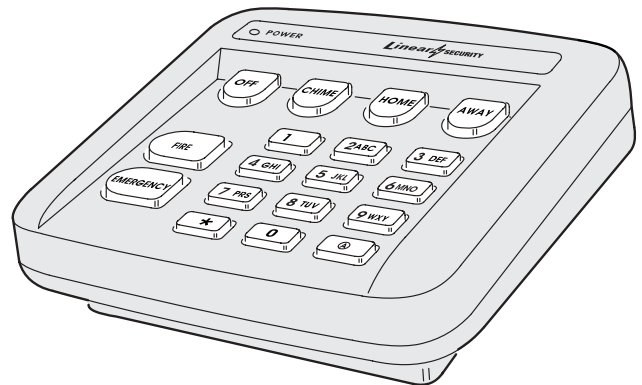

4. CONSOLE FEATURES

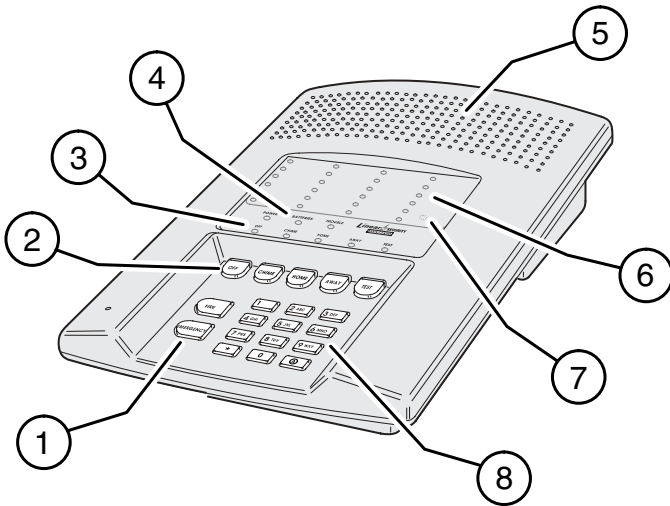

1 24-HOUR BUTTONS

- ★ Pressing the [FIRE] button for two seconds sounds the fire siren and sends a "fire" message to a central monitoring station through the digital communicator (if the system is monitored).
- ★ Pressing the [EMERGENCY] button for two seconds sounds the emergency siren and sends an "emergency" message to a central monitoring station through the digital communicator (if the system is monitored).
- ★ Both work even when system is disarmed.
- ★ **IMPORTANT: For personal emergency use only. Not for use as a UL Listed Medical Alert System.**

2 MODE BUTTONS

- ★ Used to control the Console.

OFF

- ★ Off Mode disarms the system.
- ★ Switching to Off Mode stops the alarm siren.
 - ✓ Multiple beeps sound and status lights flash if an alarm has occurred.
- ☞ **Multiple beeps mean caution. AN INTRUDER MAY STILL BE PRESENT.**

CHIME

- ★ Chime Mode disarms the system.
- ★ Switching to Chime Mode stops the alarm siren.
 - ✓ Multiple beeps sound and status lights flash if an alarm has occurred.
- ☞ **Multiple beeps mean caution. AN INTRUDER MAY STILL BE PRESENT.**
- ★ Chime Mode is for monitoring doors and windows.
 - ✓ Use this mode as an "automatic door chime" when at home.
 - ✓ Opening any protected door or window causes Console to "ding-dong".

HOME

- ★ Home Mode arms the perimeter sensors, but not the interior sensors.
 - ✓ Use this mode when anyone is staying behind.
 - ✓ Interior motion detectors and interior door sensors are not armed.
 - ✓ Home secure mode makes all delayed perimeter sensors instant.
 - ✓ Secure exit mode starts an exit delay while remaining in Home Mode.
 - ✓ Re-entering during the exit delay restarts the exit delay (one time only).

AWAY

- ★ Away Mode arms the entire system.
 - ✓ Use this mode when leaving home.
 - ✓ Door sensors set for delayed will have a delay that allows you to leave and enter the premises without sounding the alarm.
 - ✓ Re-entering during the exit delay restarts the exit delay (one time only).
 - ✓ Entry Delay beeps warn you to disarm the system before the siren starts.

TEST

- ★ Test Mode is for testing the system sensors.
 - ✓ All sensor status lights blink when the Test Mode is entered.
 - ✓ Each sensor status light will stop blinking when its sensor is tested.
- ★ Hold the [TEST] button down to test all of the Console's indicator lights.

3 MODE INDICATORS

- ★ Specific indicator will light showing the mode the Console is in.
- ★ HOME indicator will blink during secure exit and home instant modes.
- ★ AWAY indicator will blink during the exit delay in the Away Mode.

4 CONSOLE STATUS INDICATORS

- ★ Show the current status of the Console.

POWER LIGHT

- ★ Glows when AC power is on.
- ★ Dims when AC power is off and backup battery is installed.
- ★ Blinks when the backup battery is low, recharging or missing.
- ★ Off when AC power is off and no backup battery is installed (system disabled).

BATTERIES LIGHT

- ★ Blinks when one or more sensors has a low battery.
- ★ Press [*] key for one second to view sensor status. Sensor status indicator for any sensor with a low battery will light along with the BATTERIES indicator. Any trouble indications will follow during the five second status cycle.
- ★ Switch to Test Mode after replacing the sensor battery and completely test the system (see Test Mode). Switching to Test Mode clears the low battery indication.

TROUBLE LIGHT

- ★ Blinks when one or more sensors have not reported status during the eight hour status time window.
- ★ Press [*] key for one second to view sensor status. Sensor status indicator for any sensor that has not reported in will light along with the TROUBLE indicator. Any low battery indications will follow during the five second status cycle.
- ★ Switch to Test Mode after servicing the sensor and completely test the system (see Test Mode). Switching to Test Mode clears the trouble indication.

5 SIREN SPEAKER

- ★ Makes unique sounds for burglary, fire and emergencies.
- ★ Alarm sirens stop automatically after five minutes.
- ★ Sounds advisory tones to confirm keystrokes from the Console.
- ★ Sounds mode selections tones.
- ★ Sounds alarm memory tones.
- ★ Beeps when Automation Output is activated.
- ★ Speaks the system status information when optional VB-2 or VB-3 digital voice synthesis module is installed.
- ★ Terminals available for an external siren.

6 STATUS INDICATORS

- ★ Indicates the status of each of the system's sensors.
- ★ Lights show which doors and windows are open.
- ★ Lights flash to display sensors that have caused an alarm.
- ★ Stick-on labels are provided to identify the custom sensor locations.

7 CASE ACCESS SCREW (HIDDEN)

- ★ Remove clear display window and sensor identification card to gain access to the screw.
- ★ Remove case access screw to unlock case. Case hinges open to the left.

8 KEYPAD

- ★ Backlit keys for easy viewing in low light conditions.
- ★ For entering the user's user code (numerically or alphabetically).
- ★ Used when programming system options.
- ★ Press [(A)] key to activate Automation Output.
- ★ Press the [*] key to clear keypad if the wrong key is pressed.
- ★ Press and hold the [*] key for one second to view sensor battery and supervisory status (see BATTERIES and TROUBLE indicator description).

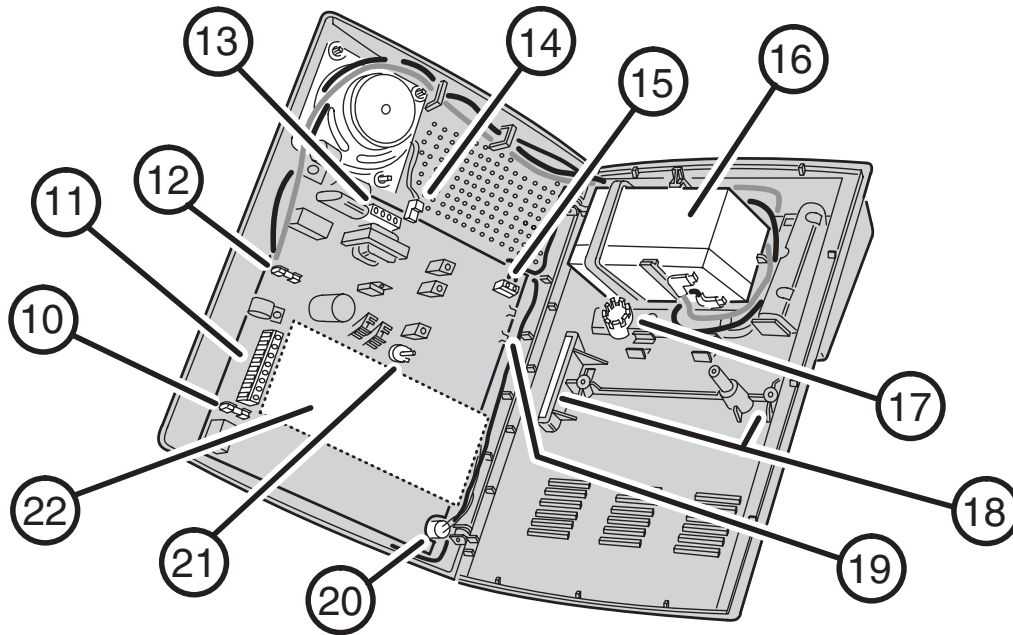

10 AUXILIARY FUSE

- ★ Type 2AG, 1-amp fuse.
 - ★ Protects the external relay output when used with wet contacts (12 VDC switched out).
 - ★ Fuse will blow when load exceeds 1 amp.
- WARNING:** For continued protection against the risk of fire, replace only with the same type and rating of fuse.

11 MAIN TERMINAL BLOCK

- ★ Terminals for connection to the plug-in AC transformer.
- ★ Terminals for connection to an external siren speaker.
- ★ Automation Output to connect to an automation controller.
- ★ External relay output for “wet” contacts (switched 12 volts) or “dry” contacts (normally open 1 amp @ 24 volts maximum).

12 BATTERY FUSE

- ★ Type 2AG, 3-amp fuse for the backup battery.
 - ★ If the POWER light is flashing and the optional backup battery is installed and charged, check this fuse.
- WARNING:** For continued protection against the risk of fire, replace only with the same type and rating of fuse.

13 TELEPHONE TERMINAL BLOCK

- ★ Provides telephone connections for the digital communicator.
- ★ Provides telephone connection for voice prompted telephone remote control (optional VB-2 digital voice synthesis module required).
- ★ Provides seized ring and tip connections for local telephone instruments. Communicator will disconnect local telephones while on-line.

14 INTERNAL SPEAKER CONNECTOR

- ★ Connects the internal speaker to the Console circuit board.
- ★ 2-pin connector, non-polarized.

15 ANTENNA TERMINALS

- ★ Antenna and ground terminals for receiving signals from the system’s sensors.
- ★ Pre-wired to the Console’s internal wire dipole antenna.
- ★ Alternately connects to the Model LA-P local whip and remote antenna kit.

16 OPTIONAL BACKUP BATTERY

- ★ Space for 12-volt, 1.2 amp/hour backup battery. (Highly recommended.)
- ★ Backup battery is automatically charged and monitored by the Console.
- ★ Backup battery can power the Console for up to 6 hours.
- ★ **UL NOTE:** Normal estimated battery life should be 3 to 4 years.

17 WIRING ACCESS HOLE

- ★ Provides access to recessed wiring trough in base of Console.
- ★ Route cables for power, telephone, external speaker, etc. through this hole.
- ★ Loop for zip-tie strain relief provided next to hole.

18 WALL-MOUNT SLOTS

- ★ Used when mounting Console recessed in the wall.
- ★ Two mounting brackets (supplied) slide through slots and are retained by screws, clamping the unit to the wall.

19 RADIO TEST POINTS

- ★ Used to monitor the Console’s radio receiver during troubleshooting.
- ★ Provides connection for an audio amplifier to listen to the receiver’s output.
- ★ Helpful to determine sources of radio interference.

20 MICROPHONE (WITH MODEL VB-2 INSTALLED ONLY)

- ★ High sensitivity microphone.
- ★ Detects room audio when communicator is reporting to the Central Station in 2-way audio mode (Model VB-2 digital voice synthesis module must be installed).

21 ANNUNCIATOR VOLUME CONTROL

- ★ Varies the volume of the advisory tones that come from the speaker.
- ★ Does **not** affect internal or external sirens (they are always full volume).

22 DIGITAL VOICE SYNTHESIS MODULE (OPTIONAL)

- ★ Two voice synthesis modules are available, the Model VB-2 and VB-3.
- ★ Both modules allow remote command of the Console using a standard pushbutton telephone, on or off site.
- ★ Both modules provide optional human voice prompts from the Console’s speaker.
- ★ The Model VB-2 gives the Console’s digital communicator listen-only, manual 2-way and full duplex 2-way audio capability with the Central Station.
- ★ Units programmed for two-way duplex can still be controlled manually by pressing the “1” or “3” key.
- ★ The Central Station can now return the unit to two-way duplex by pressing the “8” key.

5. CONSOLE INSTALLATION

CONSOLE LOCATION

NOTE: Sensor signals must be able to reach the Console.

- ✓ Try to centrally locate the Console.
- ✓ Keep Console away from large metal appliances.
- ✓ Maximum recommended sensor range is 400 feet (system tested at 1000 feet).

NOTE: If you don't use the Wireless Keypad, the Console should be easily accessible to the usual entrance.

- ✓ When the Console is set in the Away Mode, the user has 30 seconds to switch to Off Mode before the burglary siren sounds.

NOTE: Make sure the Console is in a place where the alarm can be heard during the night hours.

- ✓ Optional remote external sirens (up to 150 feet from the Console) can be used to make alarms louder and remote their location.

- Locate the Console near a 115 VAC outlet that's not controlled by a light switch.
- Locate the Console near a telephone outlet (if using the digital communicator).

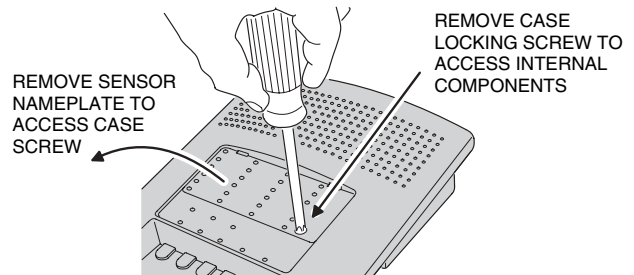
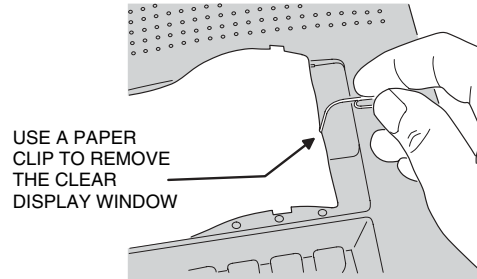

CASE LOCKING SCREW

- ◆ To access the Console's internal components or to prepare the Console for wall mounting, the case locking screw needs removing.
- Use a paper clip to remove the clear plastic display window.
- Remove the sensor number nameplate.
- Remove the case locking screw.

WALL MOUNTING

- ◆ If desired, the Console can be surface mounted or recessed into the wall.

Surface Mounting

- For surface mounting, use the Console's case bottom as a template and mark the locations for the four mounting screws.
- Use four screws and appropriate screw anchors to temporarily mount the unit to the wall (the unit will need to be removed to complete the recessed wiring hook up).

Recessed Mounting

- For recessed wall mounting, cut a 10" by 6-3/4" hole, centered between studs, in the mounting wall at a convenient height.
- Slide the unit into the mounting hole and temporarily secure it with the two retaining clamps and screws provided (the unit will need to be removed to complete the recessed wiring hook up).

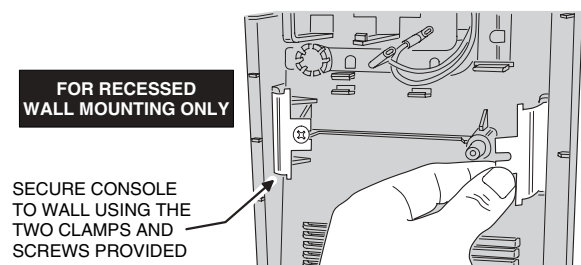
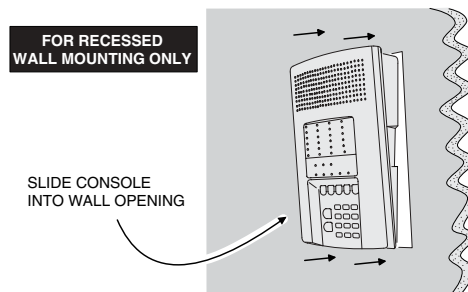
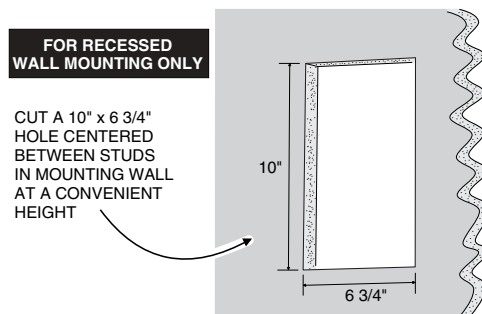

EXTERNAL CONSOLE SPEAKER CONNECTION (OPTIONAL)

- ◆ An external console speaker sounds system tones and alerts occupants with a loud siren during alarm.
- ◆ With the VB-2 module installed, the Central Station can talk to the occupants through the external console speaker.
- ◆ Use an 8-ohm, 10 watt minimum rated speaker. Do not use a horn/siren with a built-in siren driver.
- ◆ Up to two 8-ohm speakers can be used with each Console.
- ◆ Up to 150 feet of 22 AWG wire can be used with each speaker.
- Mount the external speaker.
- Route the speaker wires from the external speaker to the Console.
- Open the Console top cover and locate the main terminal block.
- Route the speaker wires up through the wiring access hole.
- Remove the wire jumper from the EXT. SPKR & (-) terminals.
- Connect the speaker wires to the EXT. SPKR & (-) terminals.
- 🔧 **NOTE:** If connecting two external speakers, connect the second speaker in parallel, to the same EXT. SPKR & (-) terminals as the first speaker.
- The system tone volume can be adjusted with the annunciator volume control.

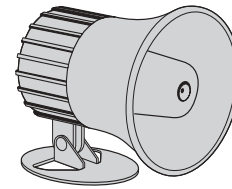

EXTERNAL CONSOLE SPEAKER

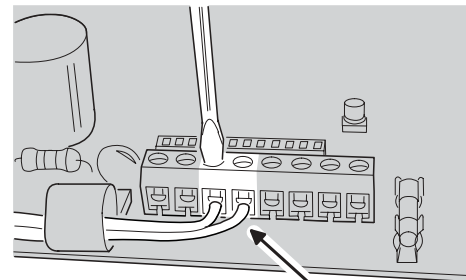
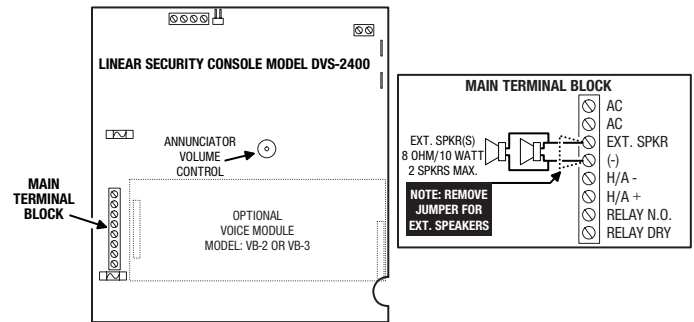

EXTERNAL CONSOLE SPEAKER
8 OHM, 10 WATT
MINIMUM

REMOVE JUMPER → → CONNECT SPEAKER LEADS TO EXT. SPKR & (-) TERMINALS

EXTERNAL ALARM SIREN CONNECTION (OPTIONAL)

- ◆ An external siren alerts occupants and neighbors with a loud siren during alarm.
- ◆ Use a 12 volt, 1 amp maximum rated weather-resistant horn speaker with a built-in siren driver. Do not use a plain speaker.
- 🔧 **NOTE:** Connection of an electromechanical bell or motor bell is not recommended because of the radio interference generated when the bell is running.
- 🔧 **UL NOTE:** Not for use in UL installations.
- Mount the external siren.
- Route the wires from the external siren to the Console.
- Open the Console top cover and locate the main terminal strip.
- Route the siren wires up through the wiring access hole.
- Connect the siren wires to the RELAY N.O. & (-) terminals.
- 🔧 **NOTE:** By removing the Console's auxiliary fuse, the relay contacts will become isolated. Use the RELAY N.O. & RELAY DRY terminals to switch an externally powered load.

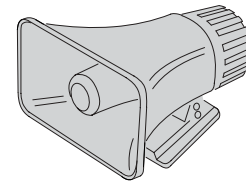

EXTERNAL ALARM SIREN

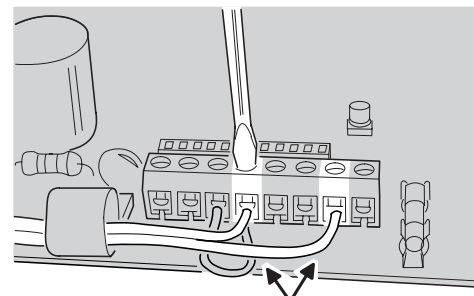
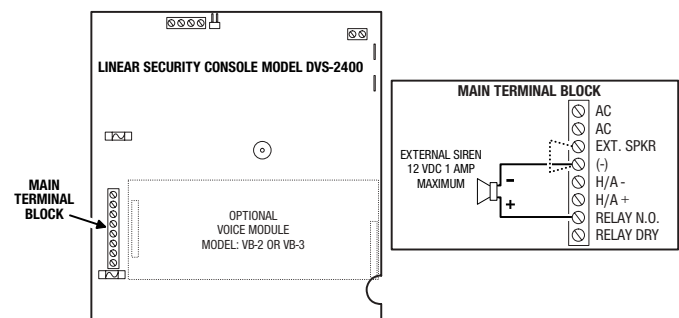

EXTERNAL ALARM RELAY
12 VDC 1 AMP
MAXIMUM

CONNECT SIREN LEADS TO (-) & RELAY N.O. TERMINALS

TELEPHONE LINE CONNECTION (OPTIONAL)

- ◆ Connect the Console to the telephone line if the system is monitored, requires 2-way audio, or requires telephone remote command.
- ◆ Telephone ring & tip terminals are for connection to the incoming telephone line.
- ◆ Seized telephone ring & tip are for connection to local telephone sets. When the communicator activates, all the local telephone sets will be disconnected to prevent an off-hook telephone on the premises from blocking the communicator call.
- Install a USOC RJ31-X or RJ38-X jack to the telephone system near the Console.
- Route an appropriate modular telephone line cord from the jack to the Console.
- Route the line cord through the Console's wiring access hole.
- Connect the incoming telephone line wires to the Console's telephone terminal block TIP and RING terminals.
- ◆ Connect the local telephone set wires to the Console's telephone terminal block SEIZED TIP and SEIZED RING terminals.
- ◆ When directly connecting (without a telephone line) to the DVS-2400 with the RA-2400 remote access software (Version 1.3 or later), disconnect the incoming telephone line and connect the modem to the panel's TIP and RING terminals (with the modem's red & green phone line wires). Press the **[EMERGENCY]** key while in Test Mode to cause the panel to connect to the modem.

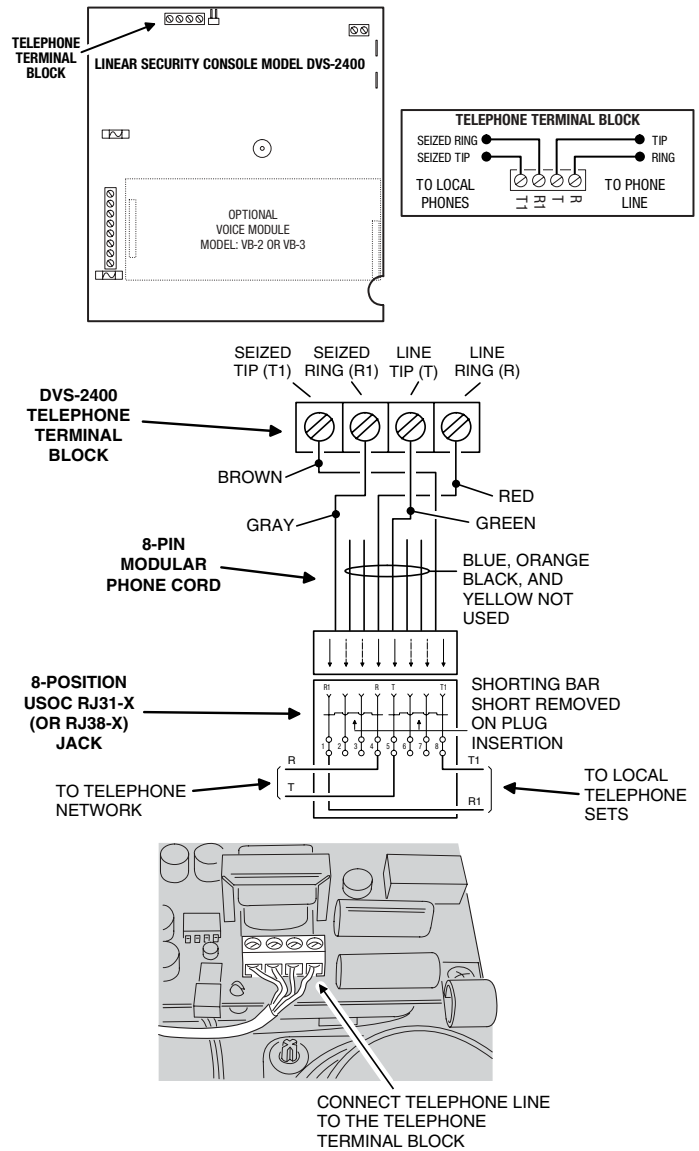

AUTOMATION OUTPUT CONNECTION (OPTIONAL)

- ◆ The Console provides a Automation Output to control lights, devices and appliances.
- ◆ Automation Output can connect to most popular home automation devices and other simple electronic devices (see Figure).
- Press **[A]** to turn the Automation Output on, press **[A]** again to turn it off.

Programmable Options

- ◆ There are many programmable options for the Automation Output.
- ◆ The Automation Output can be programmed for a variety of useful functions, such as: flashing during alarm, flashing after an alarm, on while armed, or, on during exit/entry delays.
- ◆ See the "Advanced Programming" section of this manual for details on changing the function of the Automation Output.

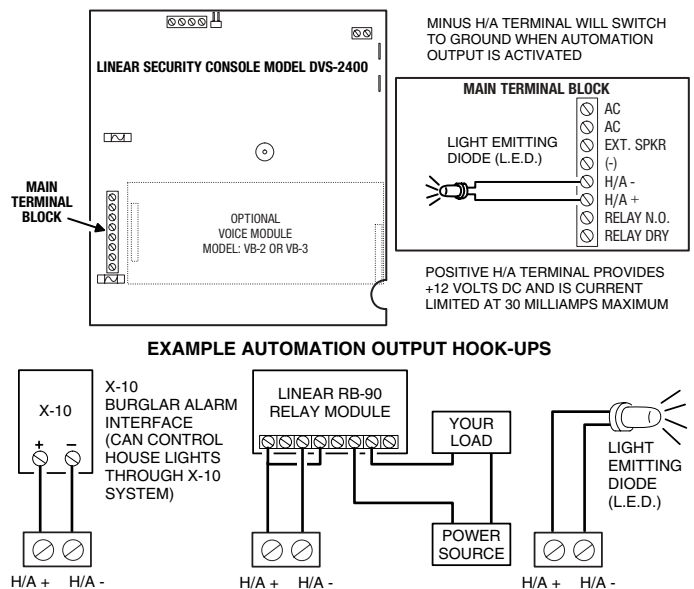

CONSOLE POWER CONNECTION

- ◆ The Console is powered by a low voltage plug-in transformer.
- ◆ Use up to 25 feet of 20 AWG or larger two-conductor wire to connect the transformer to the Console.
- Route the power wires from the plug-in transformer to the Console.
- Connect the wires to the transformer terminals (**do not plug the transformer in until the wiring is complete**).
- Route the power wires through the Console's wiring access hole.
- Connect the power wires from the transformer to the Console's main terminal block AC & AC terminals.
- Secure all of the wires entering the Console with a zip-tie to the Console's strain relief loop.
- Plug transformer into an **unswitched** AC outlet.
- Secure transformer with screw to prevent un-plugging.

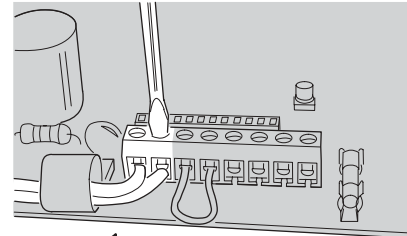
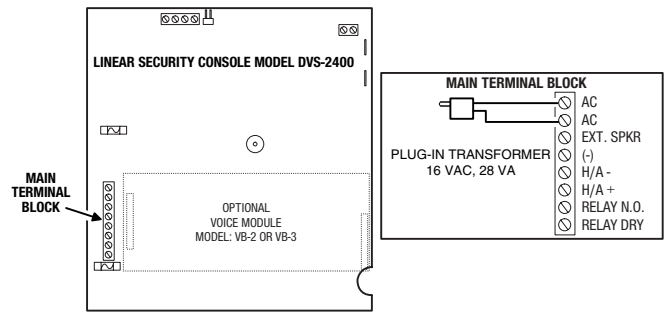

CONNECT TRANSFORMER LEADS TO AC POWER TERMINALS

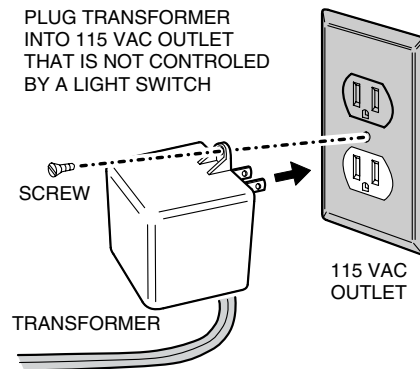

BACKUP BATTERY INSTALLATION (OPTIONAL)

- ◆ A 12 volt backup battery may be installed and is highly recommended.
- ◆ The backup battery will power the Console for up to 6 hours during AC power loss.
- ◆ The backup battery is automatically charged by the Console when AC power is present.
- ◆ A low backup battery will cause the Console POWER indicator to flash as it is being charged.
- To install the battery, slide the battery between the retaining clamps and under the battery holder.
- Position the battery until the clamps snap in place. The battery terminals should be facing the center of the Console case bottom.
- Connect the black battery lead to the black battery terminal.
- Connect the red battery lead to the red battery terminal.
- ⚠ **WARNING: DO NOT REVERSE THE BATTERY LEADS! THE BATTERY FUSE WILL BLOW.**

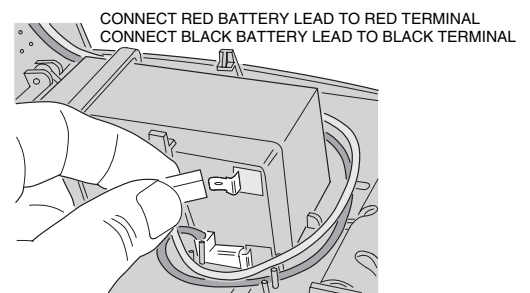
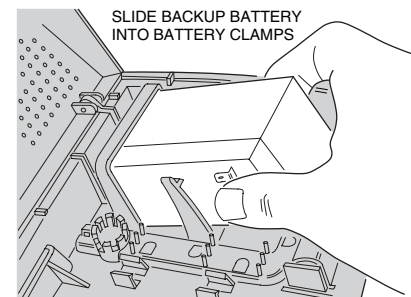

CAUTION: DO NOT REVERSE BATTERY LEADS
BATTERY FUSE WILL BLOW

6. BASIC CONSOLE PROGRAMMING

- ◆ In a new installation, when power is first applied the Console's master user code is "1234".

CREATE THE MASTER USER CODE

- 🔧 **NOTE:** Local programming must be entered on the Console's keypad, not on a wireless remote keypad.
- ☐ Press [*] (clears keypad if any other keys have been pressed).
- ☐ Place the Console in Test Mode (enter 1234 and press [TEST]).
- ✳ A "gong" and four "beeps" will sound.
- ☐ Enter the Setup Mode from Test Mode, enter 1234 the press [TEST].
- ✳ A "gong" and five "beeps" will sound.
- ☐ Enter 99 then press [HOME].
- ☐ Enter any combination of 1-5 digits for the master user code, then press [AWAY].
- 🔧 **NOTE:** For maximum security, a three to five digit code is recommended.
- ☐ Press and hold the [OFF] key for 3 seconds to exit program mode.
- ☐ Test the new master user code by entering it then pressing [TEST].
- ☐ Log the master user code in the box below.

MASTER USER CODE

- 🔧 **NOTE:** The master user code can be used to enter Setup Mode. The restricted user codes cannot. To create restricted user codes, see the "Advanced Programming" section of this manual.

PROGRAM THE SENSORS INTO THE CONSOLE'S MEMORY

- ◆ Each wireless sensor that is going to be used with the Console must be programmed into the Console's memory.
- ☐ Start with the Console in Test Mode (enter any user code and press [TEST]).
- ☐ Enter the Setup Mode from Test Mode, enter the master user code then press [TEST].
- ✳ A "gong" and five "beeps" will sound.
- ✳ The sensor status indicators will light for any sensors programmed into the Console.
- ☐ Enter an unused sensor number from 01-24 (you must enter two digits, example: 5 = 05)
- ✳ The sensor indicator light will flash for the sensor number selected.
- ☐ Activate the sensor by sending a test or alarm signal (be sure the sensor's battery is connected or that its battery protection strip is removed).
- ✳ A single "bing" tone will sound and the sensor status indicator for that sensor will stay lit.
- ☐ Enter another sensor number or exit Setup Mode by holding the [OFF] key for three seconds.

ENTERING SETUP MODE

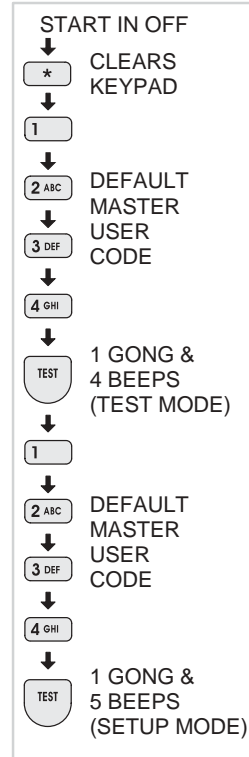

SETTING A NEW MASTER USER CODE

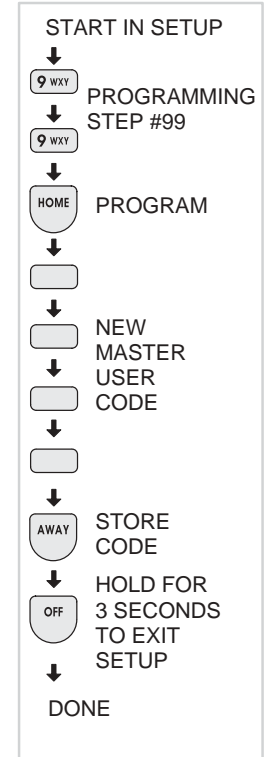

START IN TEST

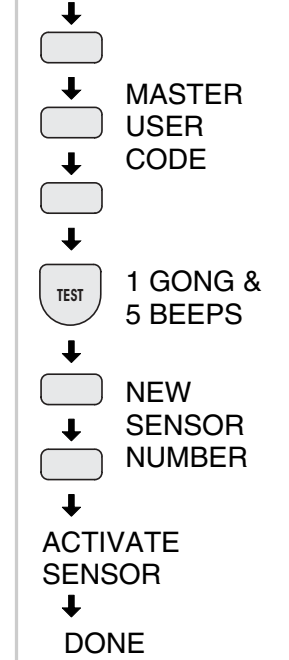

PROGRAMMING DIFFERENT SENSOR TYPES

- ◆ Follow the instructions on the previous page to select a sensor number to program the sensor into.
- 🔧 **NOTE: A sensor can be programmed into more than one location. Be sure to choose an unused sensor number. If a sensor gets entered into more than one location, delete the duplicates using the remove sensor function.**
- To add DXS-10 wireless keypads, press and hold the keypad's [*] key until programmed into the Console.
- 🔧 **IMPORTANT NOTE: The DXS-31 & DXS-32 door/window sensors are pre-set at the factory for delayed burglary response. If the sensor is going to be used on a non-entry portal (window, sliding glass door, etc.) a jumper can be changed in the sensor to select instant response. The jumper should be changed before learning the sensor so the Console will program the sensor to the proper zone. See the "Basic Sensor Installation" section of this manual for details on changing the jumper.**
- For the DXS-31 and DXS-32 door/window sensors, move the magnet away from the side of the sensor.
- For DXS-81, DXS-91, DXS-54, & DXS-72 accessory sensors, simply send a test transmission (refer to the sensor's instructions for details on sending a test transmission).
- For DXT-61, DXT-21 & DF-41 single-button remotes, simply press the unit's button. The unit will function as an arm/disarm remote.
- 🔧 **NOTE: After the Console "learns" the transmitter, single-button remotes can easily be re-programmed as "panic buttons" or home automation controllers. Refer to the "Customizing the System" section of this manual.**
- For DXT-23 & DF-42 multi-button remotes:
Learn the transmitter by pressing the left button. The remote will arm the Console with the left button and disarm with the right. Labels are provided with the DF-42 for identifying the buttons.
- 🔧 **NOTE: After the Console "learns" the transmitter, multi-button remotes can easily be re-programmed to have the left button arm/disarm the Console and the right button activate/deactivate the Home Automation Output. Refer to the "Advanced Programming" section of this manual.**
- * A single "bing" tone will sound and the sensor status indicator will stay lit when the sensor is learned by the Console.
- * A double "buzz" tone will sound if there is already another sensor programmed to that sensor number.
- Exit Setup Mode by holding the [OFF] button for two seconds. Reminder: The Console will automatically exit the Setup Mode and return to Off Mode after 3 minutes of keypad inactivity.
- 🔧 **NOTE: To remove sensors from the Console's memory, see the "Customizing the System" section of this manual.**

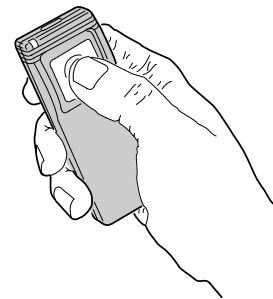
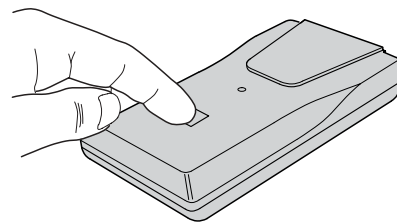
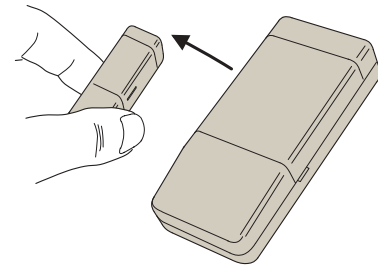

SEND SIGNAL WITH LEFT BUTTON

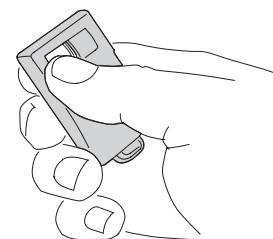

LEFT = ARM
RIGHT = DISARM
BOTH = EMERGENCY

7. BASIC SENSOR INSTALLATION

- ◆ Each accessory sensor is packaged with its own set of installation instructions specific to the model of sensor.
- ◆ Refer to the sensor's instructions for details on installing, operating, and testing of the sensor.
- ◆ Following are basic instructions for installing two popular DVS-2400 accessories: The Model DXS-10 Wireless Remote Keypad and the Model DXS-31 Door/Window Transmitter.

DXS-10 WIRELESS KEYPAD

- ◆ The DXS-10 is used to remotely command the Console.
- ◆ The keypad can be simply set on a table or mounted to a flat surface.

TABLE-TOP USE

- ◆ Four anti-mar pads are provided as scratch deterrent "feet" for the keypad.
- 🔪 **NOTE: Do not use the adhesive "feet" if the keypad is going to be wall mounted.**
- Peel off the adhesive tape backing on the "feet" and stick them to the back of the keypad.
- ◆ The wireless keypad can be used as a portable keypad. Because of the hourly supervisory transmissions, if the unit is taken out of range from the Console for more than eight hours, the Console will indicate "radio trouble" for the keypad. The keypad's sensor number can be programmed for "non-supervised" if required. See the "Advanced Programming" section of this manual.

WALL MOUNT USE

- ◆ The wireless keypad can be wall mounted in a convenient location.
- Open the keypad by inserting a small screwdriver in one of the top slots in the keypad case. Gently twist the screwdriver until the case pops open.
- Attach the rear case to the wall using the two screws provided.
- 🔪 **NOTE: For best signal transmission, the keypad should be mounted at least three feet above ground level.**
- Hook the top edge of the keypad case together and snap the keypad onto the rear case.
- 🔪 **WARNING: The wireless keypad is designed for indoor use only.**

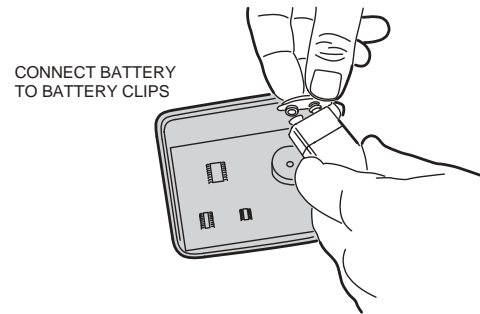
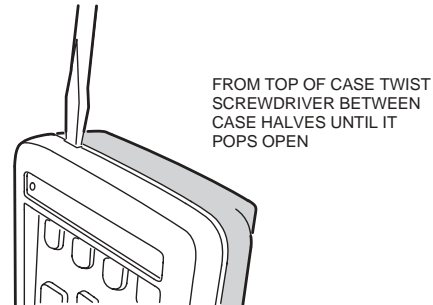

USE THE FOUR SCRATCH DETERRENT PADS PROVIDED FOR TABLE-TOP USE

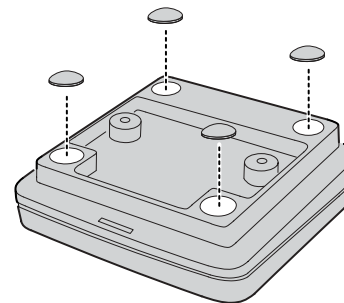

ATTACH REAR CASE TO WALL WITH THE TWO SCREWS PROVIDED

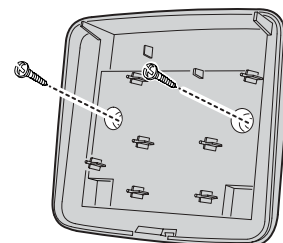

MOUNT AT A CONVENIENT LOCATION NEAR PRIMARY ENTRY/EXIT DOOR

DXS-31 DOOR/WINDOW SENSORS

- ◆ The DXS-31 sensors can be used to monitor doors, windows, cabinets, crawl space doors, gates, freezer doors, and many other moving objects that could be used for intrusion or need to be monitored.
- ◆ A built-in magnetic switch triggers the sensor when its magnet (mounted on the moving part or the door or window) moves away from the sensor.
- ◆ External normally closed switches can be wired to the sensor for remote triggering.
- ◆ The door/window sensor can connect directly to a glass break detector.

SET SENSOR JUMPER

- ◆ A jumper inside the door/window sensor selects instant or delayed response.
- If the sensor is going to be used on the primary entry/exit door make sure that the jumper is in the DELAY position.
- If the sensor is going to be used on a window or a door that is not going to be used to enter and exit the premises, set the jumper to the INSTANT position.

APPLY DOUBLE-STICK TAPE

- Apply double-stick tape (supplied) to back of sensors and magnets.
- ◆ Screws are also provided to mount sensors and magnets.
- ◆ Screws are preferred over the double-stick tape in permanent installations.
- 🔧 **UL NOTE: Double-stick tape is not allowed in UL installations.**

ATTACH SENSORS AND MAGNETS

- On doors, mount sensor to door frame and magnet to door.
- 🔧 **NOTE: Magnet must line up with mark on sensor case both horizontally & vertically.**
- Allow a maximum of 1/2" between magnet and sensor when door/window is closed.
- Snap sensor onto mounting plate.
- On windows, mount sensor to window frame and magnet to window.
- Snap sensor onto mounting plate.
- The magnet height is adjustable and an optional magnet spacer is provided for uneven surfaces.

TEST SENSORS

- * Console in Chime Mode should “ding-dong” when the sensor sends signal.
- Open door or window.
- * Verify that light on the sensor glows momentarily when door/window is opened.
- * Status indicator on Console should remain lit for each door/window sensor that is left open.

EXAMPLE INSTALLATIONS (WITH DXS-31 SHOWN)

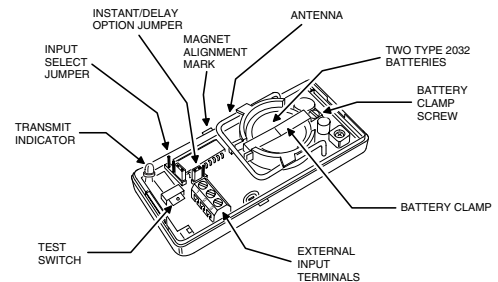
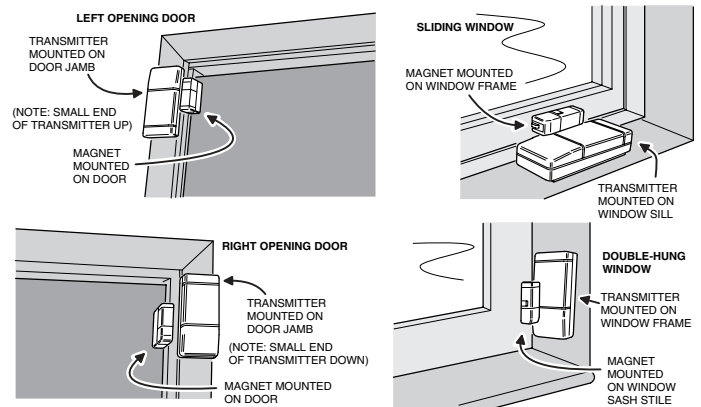

INSTANT/DELAY OPTION JUMPER

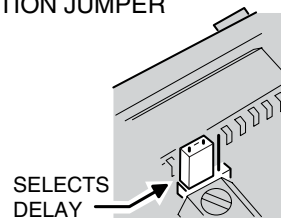

SELECTS INSTANT

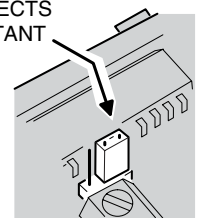

ATTACH MOUNTING PLATES USING THE SCREWS OR DOUBLE-STICK TAPE PROVIDED

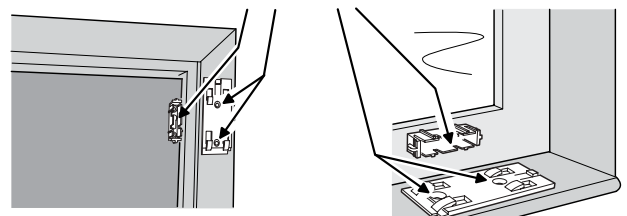

NOTE: ATTACHING THE TRANSMITTER WITH DOUBLE-STICK TAPE IS NOT ALLOWED IN UL INSTALLATIONS

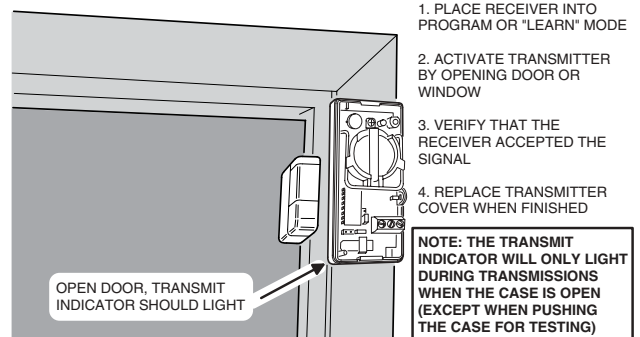

1. PLACE RECEIVER INTO PROGRAM OR "LEARN" MODE
2. ACTIVATE TRANSMITTER BY OPENING DOOR OR WINDOW
3. VERIFY THAT THE RECEIVER ACCEPTED THE SIGNAL
4. REPLACE TRANSMITTER COVER WHEN FINISHED

NOTE: THE TRANSMIT INDICATOR WILL ONLY LIGHT DURING TRANSMISSIONS WHEN THE CASE IS OPEN (EXCEPT WHEN PUSHING THE CASE FOR TESTING)

8. CUSTOMIZING THE CONSOLE

- ◆ The Console can be customized for the specific installation.
- ◆ A label sheet with sensor location names is provided with the Console.
- ◆ Labeling the sensors allows quick and easy identification of where any alarms have occurred, where a sensor with a low battery is, where a sensor with radio trouble is, etc.

LABELING THE SENSORS

- Use a paper clip to remove the clear display window.
- Bend down the tabs on the sensor number card and fit it onto the Console.
- Open one protected door/window to light its sensor status light on the Console.
- Choose a label that describes the sensor location, or write the location on a blank label, and stick it in the area to the right of the sensor light.
- Close the protected opening that you just labeled.
- Repeat for each protected opening.
- Stick the WIRELESS KEYPAD label in the sensor number location for the wireless keypad (if used).
- Replace the clear display window when finished.

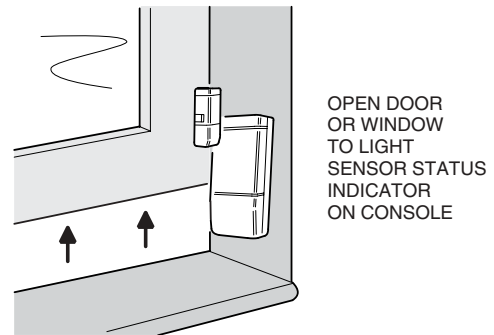
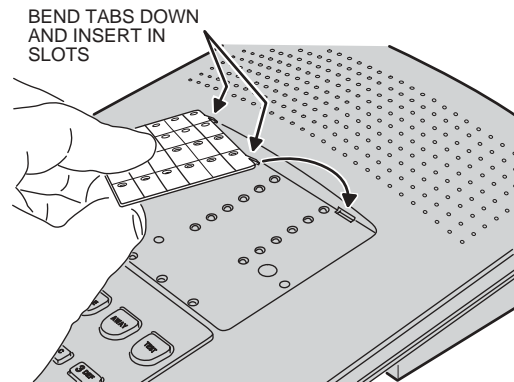
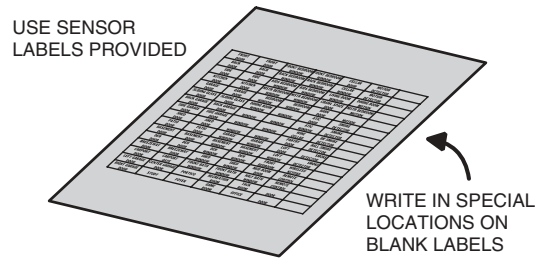

APPLY SENSOR IDENTIFICATION LABELS TO THE APPROPRIATE SENSOR LOCATIONS

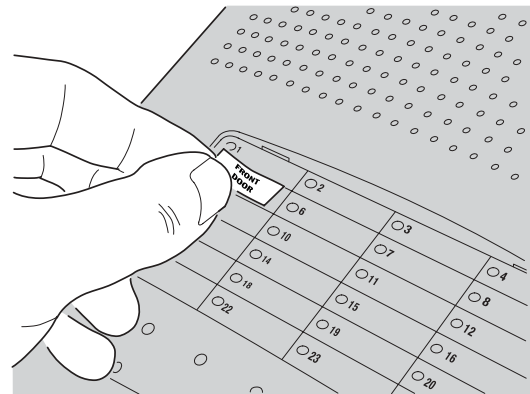

9. CONSOLE OPERATING MODES

OFF MODE

- ◆ Use this mode to disarm the burglary portion of the system.
- ◆ Switching to Off Mode stops any alarms in progress.
- ◆ The 24-hour functions are still active in Off Mode and can be triggered by pressing the **[FIRE]** or **[EMERGENCY]** button.
- Switch to Off Mode by entering the user code, and pressing **[OFF]**.
- * When the system is disarmed to Off Mode, the Console will sound one “Gong”.
- * If an alarm has occurred, multiple beeps will sound after disarming and the sensor light for the sensor(s) that caused the alarm will flash.
- 🔊 **NOTE: In Off Mode, protected doors and windows cannot trigger the burglary alarm.**

OFF MODE

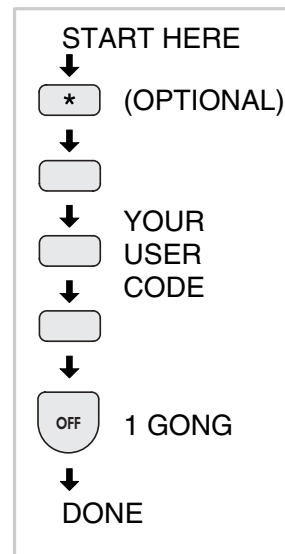

CHIME MODE

- ◆ Chime Mode is for monitoring entries and exits without causing alarms.
- ◆ Use Chime Mode as an “automatic door chime” when at home.
- * Opening any protected door or window causes the Console to sound a “ding-dong”.
- Select the Chime Mode by entering a user code, then press **[CHIME]**.
- The user can enter Chime Mode from Off Mode by holding down the **[CHIME]** key for two seconds.
- * When the system is switched to the Chime Mode, the Console will sound a “Gong” and one “Beep”.
- ◆ Going to Chime Mode disarms the system and stops any alarms in progress.
- 🔊 **NOTE: In Chime Mode, protected doors and windows cannot trigger the burglary alarm.**

CHIME MODE

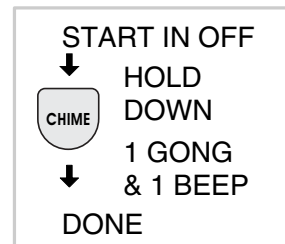
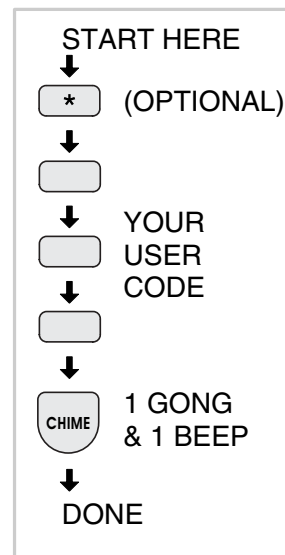

HOME MODE

- ◆ Use this mode when sleeping or when anyone is staying inside.
- ◆ Home Mode causes an instant alarm when any perimeter sensor is triggered.
- ◆ Home Mode causes a delayed alarm when any exit/entry sensor is triggered (except in Home Instant Mode when they are instant).
- ◆ Alarm siren stops automatically after five minutes and the system will remain armed.
- ◆ Home Mode ignores all interior sensors (motion detectors, etc.).
- Arm to Home Mode by entering a user code, and pressing [HOME].
- The user can “Quick Arm” to Home Mode from Off or Chime Mode by holding down the [HOME] key for two seconds. (Quick arming can be disabled; see the “Advanced Programming” section of this manual.)
- ※ When the system is armed to the Home Mode, the Console will sound a “Gong” and two “Beeps”.
- Enter a user code and press [OFF] or [CHIME] to disarm from Home Mode and/or stop the alarm siren.
- ※ If an alarm has occurred, multiple beeps will sound after disarming and the sensor light for the sensor(s) that caused the alarm will flash (switch to Off Mode again or re-arm the Console to stop the flashing alarm memory light).

SECURE EXIT

- If the system is already in the Home Mode and the user wants to exit the premises while leaving someone inside *with the system still in Home Mode*, enter a user code and press the [HOME] key.
- ※ A “gong” and two “beeps” will sound and the HOME light will blink for 60 seconds. No exit delay beeps will sound during the Exit Delay.
- ◆ The user can leave through a door with a delayed perimeter sensor during the 60 second Exit Delay without causing the Console to begin an Entry Delay.
- ◆ Re-entering during the silent Exit Delay will extend the Exit Delay another 60 seconds (one time only).
- 🔧 **NOTE: The Exit Delay time can be changed; see the “Advanced Programming” section of this manual.**

HOME INSTANT MODE

- If the system is already in the Home Mode and the user wants to make all exit/entry sensors instant, press the [HOME] key for 2 seconds.
- ※ Two “gongs” and two “beeps” will sound and the HOME light will blink continuously.
- ◆ Because all exit/entry sensors will now cause an **instant** alarm when in Home Mode, the Console must be disarmed before opening any exit/entry delay door.

MANUAL BYPASSING OF SENSORS

- ◆ Manual bypassing of sensors in the Home Mode allows arming of the system at night with open windows, while still having perimeter protection with other closed doors and windows.
- ◆ The Console will resist arming with open door or window sensors.
- ※ Four high-low beeps to warn the user that something is open and the system will remain in the previous mode.
- ※ Lit sensor status indicators show which sensors are open.
- To manually bypass the open sensors, arm the system again *within 5 seconds*.
- ※ A “gong” and two “beeps” will sound, the HOME indicator will light, and the open sensors will be bypassed.
- 🔧 **WARNING: Bypassed sensors cannot cause an alarm.**

HOME MODE

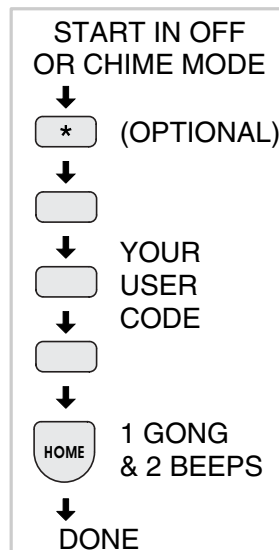

SECURE EXIT

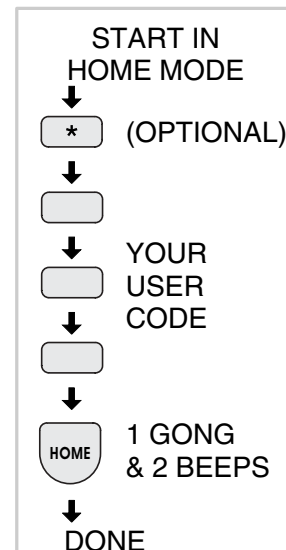

QUICK ARM

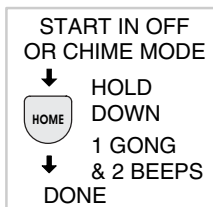

HOME INSTANT MODE

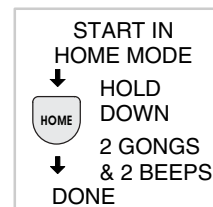

AWAY MODE

- ◆ Use this mode when no one will be staying home.
- ◆ Each burglary sensor can trigger the siren once per arming period.
- ◆ Away Mode causes an **instant** alarm when any perimeter sensor is triggered.
- ◆ Away Mode causes a **delayed** alarm when any exit/entry sensor is triggered.
- ◆ Away Mode causes an **instant** alarm when any interior sensors (motion detectors, etc.) are triggered. The interior sensors will be **delayed** if a perimeter delayed sensor is triggered first.
- ◆ Alarm siren stops automatically after five minutes and the system will remain armed.
- Arm to Away Mode by entering a user code, and pressing **[AWAY]**.
- The user can “Quick Arm” to Away Mode from Home, Chime or Off Mode by holding down the **[AWAY]** key for two seconds. (Quick arming can be disabled; see the “Advanced Programming” section of this manual.)

EXIT DELAY (For Leaving the Premises)

- ※ When the system is armed to the Away Mode, the Console will sound a “Gong” and three “Beeps”.
- ※ During the 60 second Exit Delay, the Console will sound “beeps” (double beeps last 10 seconds) and the AWAY light will blink.
- ◆ The Exit Delay gives the user **60 seconds** to leave the premises through an exit/entry door without triggering an alarm.
- ◆ Re-entering during the Exit Delay will extend the Exit Delay another 60 seconds (one time only).
- ※ When the Exit Delay is over, the Console will sound one “gong” to warn the user that the system is fully armed.

🔧 **NOTE:** The Exit Delay time can be changed; see the “Advanced Programming” section of this manual.

ENTRY DELAY (For Entering the Premises)

- ◆ The Entry Delay gives the user **30 seconds** to enter the premises through an exit/entry door without triggering an alarm.
- ◆ If a exit/entry sensor is triggered, starting the Entry Delay, the interior sensors will also become **delayed** (this allows motion in the premises during the Entry Delay).
- ※ During the 30 second Entry Delay, the Console will sound “beeps”.
- ◆ When the Entry Delay is over, the Console will go into full alarm and sound the siren if it is not disarmed to the Off or Chime Mode.
- ※ If an alarm has occurred while the user was gone, multiple beeps will sound after disarming and the sensor light for the sensor(s) that caused the alarm will flash (switch to Off Mode again or re-arm the Console to stop the flashing alarm memory light).

🔧 **NOTE:** The Entry Delay time can be changed; see the “Advanced Programming” section of this manual.

MANUAL BYPASSING OF SENSORS

- ◆ Manual bypassing of sensors in the Away Mode allows arming of the system with open doors and windows, while still having perimeter protection with other closed doors and windows.
- ◆ The Console will resist arming with open door or window sensors.
- ※ Four high-low beeps to warn the user that something is open and the system will remain in the previous mode.
- ※ Lit sensor status indicators show which sensors are open.
- To manually bypass the open sensors, arm the system again *within 5 seconds*.
- ※ A “gong” and three “beeps” will sound, the AWAY indicator will light, and the open sensors will be bypassed.
- 🔧 **WARNING:** Bypassed sensors cannot cause an alarm.

AWAY MODE

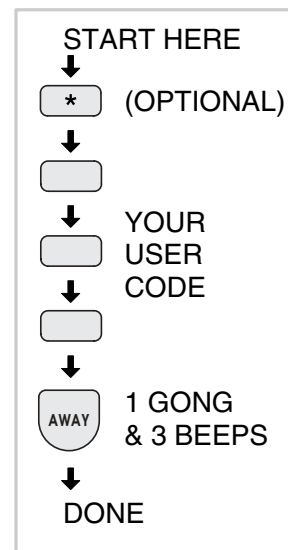

QUICK ARM



TEST MODE

- ◆ Even though this is a self-monitoring supervised system, the National Burglar and Fire Alarm Association recommends that all security systems should be tested manually on a regular basis.
- ◆ The Console must be in Off Mode before going to Test Mode.
- Switch the Console into Test Mode by entering a user code and pressing [TEST].
- ✱ When the system is switched to the Test Mode, the Console will sound a “Gong” and four “Beeps”.
- Holding down the [TEST] button in Test Mode will light all of the Console’s indicators.
- ✱ The sensor status lights will flash for each sensor programmed into the Console.
- Go to each sensor and press its test button or open and close the protected opening.
- To test the wireless keypad, press the [(A)] key.
- ✱ The Console will make a “bing” sound as each sensor is tested, followed by 1-3 beeps indicating signal strength with 3 beeps being the strongest signal.
- ✱ As each sensor is tested, the sensor status light for the sensor will stop flashing and return to showing the current status of the sensor.
- Continue testing until there are no flashing status lights.
- 🔊 **NOTE: If the Console is left unattended in Test Mode, it will automatically switch back to Off Mode after 3 minutes.**
- ◆ When directly connecting (without a telephone line) to the DVS-2400 with the RA-2400 remote access software (Version 1.3 or later), press the [EMERGENCY] key while in Test Mode to cause the Console to connect to the modem.

TEST MODE

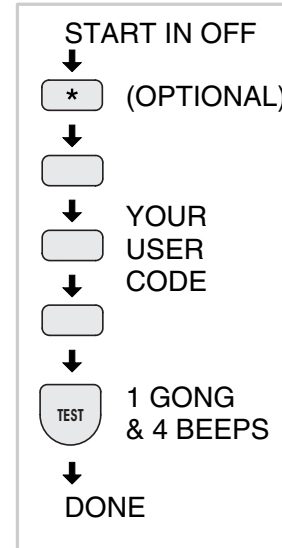

SENSOR FUNCTION IN EACH CONSOLE MODE

SENSOR TYPE	OFF MODE	CHIME MODE	HOME MODE	AWAY MODE
AUTOMATION	ACTIVATES AND DEACTIVATES THE AUTOMATION OUTPUT			
EMERGENCY	ARMED 24-HOURS - TRIGGERS EMERGENCY ALARM			
PANIC	ARMED 24-HOURS - TRIGGERS SILENT PANIC ALARM			
FIRE	ARMED 24-HOURS - TRIGGERS FIRE ALARM			
PERIMETER	DEACTIVATED	CHIME	INSTANT BURGLARY ALARM	
EXIT/ENTRY	DEACTIVATED	CHIME	DELAYED BURGLARY ALARM	
INTERIOR	DEACTIVATED	DEACTIVATED	DEACTIVATED	FOLLOWER (INSTANT BURGLARY ALARM UNLESS ACTIVATED DURING ENTRY DELAY)
CHIME	CHIME			
2-BUTTON ARM/DISARM (LEFT) 2-BUTTON AUTOMATION (RIGHT) EMERGENCY (BOTH)	LEFT BUTTON SWITCHES CONSOLE TO AWAY OR HOME MODE (PROGRAMMING FUNCTION 50) IF ALARM MEMORY IS ACTIVE, SWITCHES CONSOLE TO OFF OR CHIME MODE (PROGRAMMING FUNCTION 51)		LEFT BUTTON SWITCHES TO OFF OR CHIME MODE (PROGRAMMING FUNCTION 51)	
2-BUTTON ARM (LEFT) 2-BUTTON DISARM (RIGHT)	LEFT BUTTON SWITCHES CONSOLE TO AWAY OR HOME MODE (PROGRAMMING FUNCTION 50) IF ALARM MEMORY IS ACTIVE, SWITCHES CONSOLE TO OFF OR CHIME MODE (PROGRAMMING FUNCTION 51)		RIGHT BUTTON SWITCHES TO OFF OR CHIME MODE (PROGRAMMING FUNCTION 51)	
ENVIRONMENTAL	ARMED 24-HOURS - TRIGGERS ANNUNCIATION ONLY			
INTERIOR HOME	DEACTIVATED	DEACTIVATED	INSTANT BURGLARY ALARM	

Console Zone Table

10. SYSTEM TROUBLE INDICATIONS

- ◆ The DVS-2400 Console is a self-monitoring supervised wireless system.
- ◆ If the Console detects a problem with any of the supervised system sensors or backup battery, it will display the appropriate trouble indication and, if monitored, report the trouble to the Central Station through the communicator (depending on communicator programming).

CONSOLE LOW BATTERY

- ◆ The Console constantly charges and monitors the optional backup battery (if installed).
- ◆ If the backup battery condition is abnormal, the Console's POWER light will indicate the trouble.
- * The POWER indicator normally glows when AC power is on.
- * With a charged backup battery installed, if the Console loses AC power, the POWER indicator will dim as the Console runs on the backup battery.
- * If the backup battery is low, recharging, or not installed, the POWER indicator blinks when AC power is present.
- * If the AC power is off and no backup battery is installed, the POWER indicator will be off (in this case the system has no power and is disabled).
- Normal battery life for the type of backup battery used in the Console is 3-4 years. If the battery does not take a charge in 72 hours, it should be replaced.

SENSOR LOW BATTERIES

- * When the BATTERIES indicator on the Console blinks, one or more sensors have a low battery.
- Press [*] key for one second to view sensor status. Sensor status indicator for any sensor with a low battery will light along with the BATTERIES indicator. Any trouble indications will follow during the five second status cycle.
- Replace the sensor's battery as described in their instructions.
- Switch to Test Mode after replacing the sensor battery and completely test the system (see Test Mode). Switching to Test Mode clears the low battery indication.

SENSOR RADIO TROUBLE

- * When the TROUBLE indicator blinks, one or more sensors have not reported status during the eight hour status time window.
- Press [*] key for one second to view sensor status. Sensor status indicator for any sensor that has not reported in will light along with the TROUBLE indicator. Any low battery indications will follow during the five second status cycle.
- Switch to Test Mode after servicing the sensor and completely test the system (see Test Mode). Switching to Test Mode clears the trouble indication.

POWER INDICATOR

ON WITH AC POWER AND CHARGED BACKUP BATTERY

BLINKS WITH LOW, RECHARGING OR MISSING BACKUP BATTERY

DIM WHEN AC POWER IS ABSENT AND CONSOLE IS RUNNING ON BACKUP BATTERY

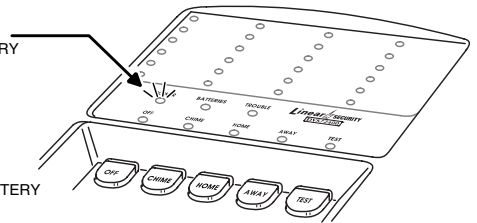

BATTERIES INDICATOR

BLINKS WHEN ONE OR MORE SENSORS HAVE A LOW BATTERY

LIGHTS WITH SENSOR INDICATOR DURING LOW BATTERY STATUS CHECK (PRESS * FOR 1 SECOND)

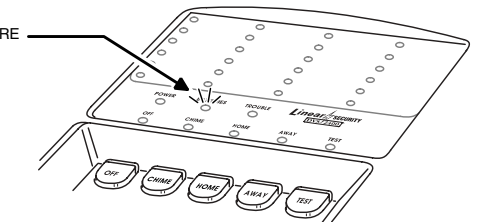

TROUBLE INDICATOR

BLINKS WHEN ONE OR MORE SENSORS HAVE NOT REPORTED STATUS DURING THE EIGHT HOUR STATUS TIME WINDOW

LIGHTS WITH SENSOR INDICATOR DURING TRANSMITTER STATUS CHECK (PRESS * FOR 1 SECOND)

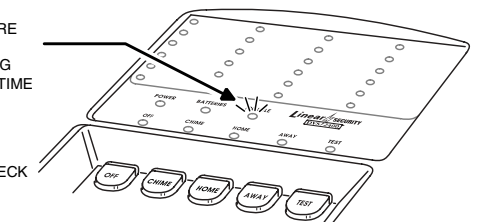

11. CUSTOMIZING THE SYSTEM

- ◆ Adding additional sensors will increase the protection provided by the system.
- ◆ All ground-level perimeter openings and accessible upper-story openings need protection.
- ◆ Motion detectors can protect interior areas and areas where valuables are kept.

ADDING SENSORS TO THE SYSTEM

- Always start with the Console in Test Mode (enter a user code and press [TEST]).
- Enter the master user code then press the [TEST] button.
- ※ A “gong” and five “beeps” will sound.
- ※ The sensor status indicators will light for each sensor programmed into the Console.
- Enter an **unused** sensor number from 01-24 (you must enter two digits, example: 5 = 05).
- 🔗 **NOTE: A sensor can be learned into more than one location. Be sure to choose an unused sensor number. If a sensor gets entered into more than one location, delete the duplicates using the remove sensor function.**
- ※ The sensor indicator light will flash for the sensor number selected.
- Activate the sensor. (To add a wireless keypad, press the keypad’s [*] key.)
- ※ A single “bing” tone will sound when the sensor is learned by the Console and the sensor status indicator will stay lit.
- Enter another sensor number or exit Setup Mode by holding the [OFF] button for three seconds.

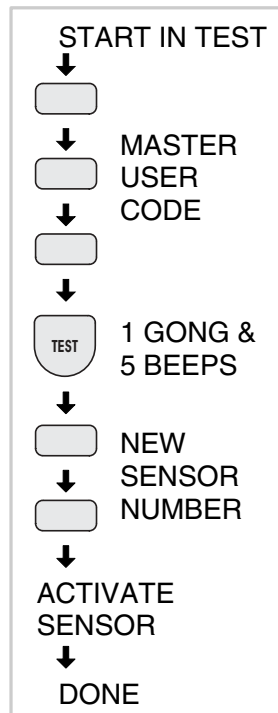

REMOVING SENSORS FROM THE SYSTEM

- ◆ If a previously learned sensor isn't going to be used with the system anymore, or it's a duplicate that has been entered into more than one sensor location, it should be removed from the Console's memory.
- ◆ Start with the Console in Test Mode.
- Enter the master user code then press the [TEST] button.
- ※ A “gong” and five “beeps” will sound.
- ※ The sensor status indicators will light for each sensor programmed into the Console.
- Enter the sensor number (from 01-24) that you want to remove (you must enter two digits, example: 5 = 05).
- ※ The sensor indicator light will flash for the sensor number selected.
- Press the [TEST] button.
- ※ A single “bing” tone will sound when the sensor has been removed and the sensor status indicator will turn off.
- Enter another sensor number or exit Setup Mode by holding the [OFF] button for three seconds.

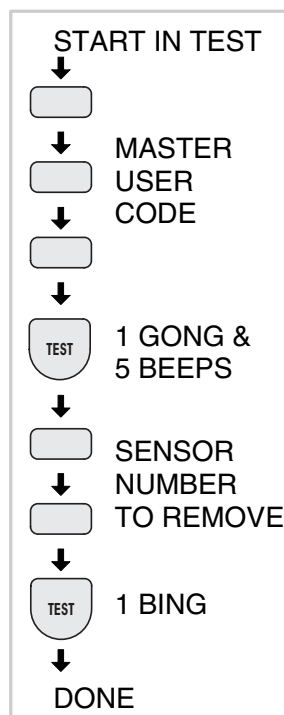

MAKING A SENSOR A 24-HOUR DOOR CHIME

- ◆ Sensors can be programmed to cause the Console to chime any time they're activated.
- ◆ Chime-only sensors **will not** be able to trigger the alarm in any Console mode.
- ◆ The sensor must have already been learned by the Console (see "Adding sensors to the System" for details).
- Start with the Console in Test Mode.
- Enter the master user code then press the [TEST] button.
- * A "gong" and five "beeps" will sound.
- * The sensor status indicators will light for each sensor programmed into the Console.
- Enter the sensor number from 01-24 (you must enter two digits, example: 5 = 05).
- * The sensor indicator light will flash for the sensor number selected.
- Press [HOME], 8, then [AWAY]. A "bing" tone will sound.
- Enter another sensor number or exit Setup Mode by holding the [OFF] button for three seconds.

MAKING A SENSOR INTERIOR

- ◆ Motion detectors are automatically programmed as interior sensors. Any other sensor can also be programmed as an interior sensor.
- ◆ Interior sensors can only trigger an alarm when the Console is in Away Mode.
- ◆ "Home Interior" sensors can trigger an alarm when the Console is in the Home or Away mode.
- ◆ The sensor must have already been learned by the Console (see "Adding sensors to the System" for details).
- Start with the Console in Test Mode.
- Enter the master user code then press the [TEST] button.
- * A "gong" and five "beeps" will sound.
- * The sensor status indicators will light for each sensor programmed into the Console.
- Enter the sensor number from 01-24 (you must enter two digits, example: 5 = 05).
- * The sensor indicator light will flash for the sensor number selected.
- Press [HOME], 7, then [AWAY]. A "bing" tone will sound.
- Enter another sensor number or exit Setup Mode by holding the [OFF] button for three seconds.

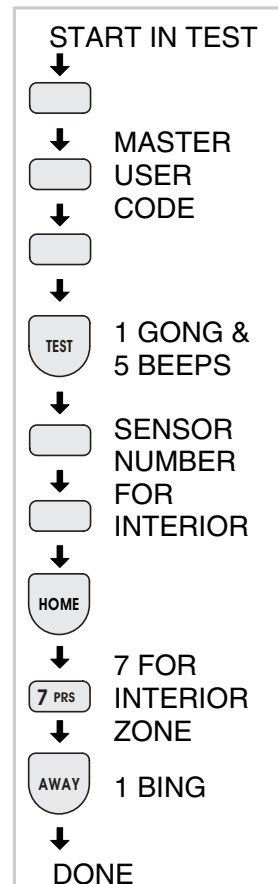
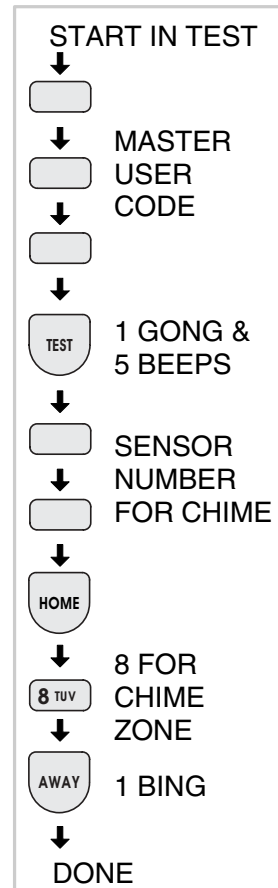

MAKING A SENSOR ACTIVATE A DIFFERENT ZONE

- ◆ Any sensor can be reprogrammed to activate any of the Console's zones.
- ◆ The sensor must have already been learned by the Console (see "Adding sensors to the System" for details).
- Start with the Console in Test Mode.
- Enter the master user code then press the **[TEST]** button.
- ✱ A "gong" and five "beeps" will sound.
- ✱ The sensor status indicators will light for each sensor programmed into the Console.
- Enter the sensor number from 01-24 (you must enter two digits, example: 5 = 05).
- ✱ The sensor indicator light will flash for the sensor number selected.
- Choose a zone number from the Console Zone Table.
- Press **[HOME]**, the new zone number, then **[AWAY]**. A "bing" tone will sound.
- Enter another sensor number or exit Setup Mode by holding the **[OFF]** button for three seconds.

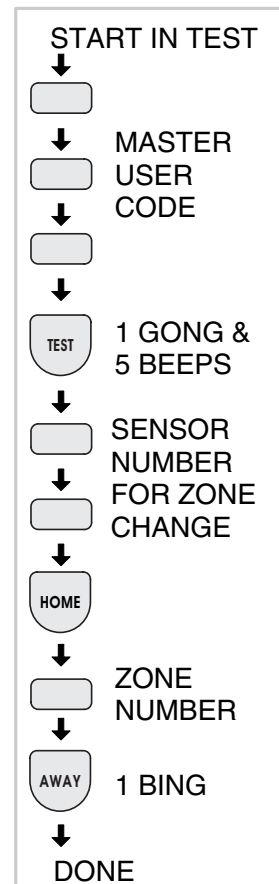

PROGRAMMING INFORMATION		SENSOR FUNCTION IN EACH CONSOLE MODE			
ZONE #	SENSOR TYPE	OFF MODE	CHIME MODE	HOME MODE	AWAY MODE
1	AUTOMATION	ACTIVATES AND DEACTIVATES THE AUTOMATION OUTPUT			
2	EMERGENCY	ARMED 24-HOURS - TRIGGERS EMERGENCY ALARM			
3	PANIC	ARMED 24-HOURS - TRIGGERS SILENT PANIC ALARM			
4	FIRE	ARMED 24-HOURS - TRIGGERS FIRE ALARM			
5	PERIMETER	DEACTIVATED	CHIME	INSTANT BURGLARY ALARM	
6	EXIT/ENTRY	DEACTIVATED	CHIME	DELAYED BURGLARY ALARM	
7	INTERIOR	DEACTIVATED	DEACTIVATED	DEACTIVATED	FOLLOWER (INSTANT BURGLARY ALARM UNLESS ACTIVATED DURING ENTRY DELAY)
8	CHIME	CHIME			
9	2-BUTTON ARM/DISARM (LEFT) 2-BUTTON AUTOMATION (RIGHT)	LEFT BUTTON SWITCHES CONSOLE TO AWAY OR HOME MODE (PROGRAMMING FUNCTION 50) IF ALARM IS ACTIVE, SWITCHES CONSOLE TO OFF OR CHIME MODE (PROGRAMMING FUNCTION 51)		LEFT BUTTON SWITCHES TO OFF OR CHIME MODE (PROGRAMMING FUNCTION 51)	
10	2-BUTTON ARM (LEFT) 2-BUTTON DISARM (RIGHT)	LEFT BUTTON SWITCHES CONSOLE TO AWAY OR HOME MODE (PROGRAMMING FUNCTION 50) IF ALARM IS ACTIVE, SWITCHES CONSOLE TO OFF OR CHIME MODE (PROGRAMMING FUNCTION 51)		RIGHT BUTTON SWITCHES TO OFF OR CHIME MODE (PROGRAMMING FUNCTION 51)	
11	ENVIRONMENTAL	ARMED 24-HOURS - TRIGGERS ANNUNCIATION ONLY			
12	INTERIOR HOME	DEACTIVATED	DEACTIVATED	INSTANT BURGLARY ALARM	

Console Zone Table

12. ADVANCED PROGRAMMING

- ◆ To perform any of the advanced programming steps, the Console must be in the Setup Mode.
- ◆ Each programming function is performed with similar keystrokes. After the Console is in Setup Mode, enter the programming step number, press the [HOME] key (HOME = program), enter the new value, and press the [AWAY] key (AWAY = store). Follow the figures next to the programming steps.

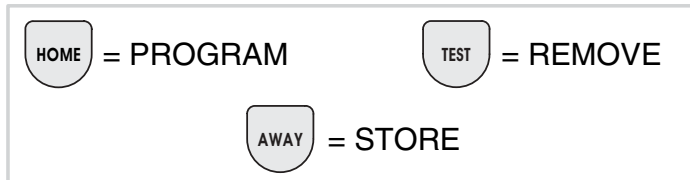

SETUP MODE

- Start with the Console in Test Mode (Setup Mode cannot be reached from any other mode).
- From Test Mode, enter the master user code then press [TEST].
- 🔗 **NOTE: Only the master user code can be used to put the Console into the Setup Mode. The restricted user codes cannot access Setup Mode.**
- ✳ A “gong” and five “beeps” will sound, signaling that the Console is in Setup Mode.
- Hold the [OFF] key for three seconds when you want to exit Setup Mode.
- 🔗 **NOTE: If the Console is left unattended in Setup Mode, it will automatically switch back to Off Mode after three minutes.**

CONSOLE PROGRAMMING OPTIONS				
STEP #	PROGRAMMING FUNCTION	POSSIBLE VALUES	FACTORY VALUE	INSTALLATION VALUE
25	ENTRY DELAY	20-255 SECONDS	30	
26	EXIT DELAY	20-255 SECONDS	60	
30	BURGLARY SIREN TIME	1-30 MINUTES	5	
31	EMERGENCY SIREN TIME	1-30 MINUTES	5	
32	FIRE SIREN TIME	1-30 MINUTES	5	
40	AUTOMATION OUTPUT TIME	0-2500 SECONDS (0 = TOGGLE ON/OFF)	0	
50	REMOTE ARMING MODE	2 = HOME MODE; 3 = AWAY MODE	3	
51	REMOTE DISARMING MODE	0 = OFF MODE; 1 = CHIME MODE	0	
61	ENTRY DELAY BEEPS	0 = OFF; 1 = ON	1	
62	EXIT DELAY BEEPS	0 = OFF; 1 = ON	1	
63	SILENT BURGLARY ALARM	0 = AUDIBLE; 1 = SILENT	0	
64	SILENT EMERGENCY ALARM	0 = AUDIBLE; 1 = SILENT	0	
65	QUICK ARMING	0 = OFF; 1 = ON	1	
66	AUTO RESTORE	0 = OFF; 1 = ON	1	
67	AUTO BYPASS	0 = OFF; 1 = ON	0	
68	AUTOMATION MODE DURING ALARM	0 = FLASH (ENABLED BY FUNCTION 72) 1 = STEADY (ENABLED BY FUNCTION 72)	0	
69	AUTOMATION BING TONE	0 = NO BINGS 1 = BINGS	1	
70	REMOTE ARM/DISARM CHIRP	0 = NO CHIRPS 1 = CHIRPS (1 CHIRP = ARMED, 2 CHIRPS = DISARMED)	1	
71	AUTOMATION FLASHES AFTER ALARM	0 = STANDARD 1 = FLASHING AFTER ALARM	0	
72	AUTOMATION ACTIVE DURING ALARM	0 = STANDARD 1 = AUTOMATION ACTIVE DURING ALARM (FLASH OR STEADY PROGRAMMED BY FUNCTION 68)	0	
73	AUTOMATION ON WHILE ARMED	0 = STANDARD 1 = ON WHILE ARMED	0	
74	AUTOMATION ON DURING EXIT/ENTRY	0 = STANDARD 1 = ON DURING EXIT/ENTRY DELAYS	0	
75	AUTOMATION POLARITY	0 = + WHEN OFF; 1 = + WHEN ON	1	
87	REMOTE ACCESS PASSWORD	6 DIGITS	987654	
92	DURESS CODE	1-5 DIGITS	REMOVED	
93	RESTRICTED USER CODE #1	1-5 DIGITS	REMOVED	
94	RESTRICTED USER CODE #2	1-5 DIGITS	REMOVED	
95	RESTRICTED USER CODE #3	1-5 DIGITS	REMOVED	
96	RESTRICTED USER CODE #4	1-5 DIGITS	REMOVED	
97	RESTRICTED USER CODE #5	1-5 DIGITS	REMOVED	
98	PAGE ALERT USER CODE	1-5 DIGITS	REMOVED	
99	MASTER USER CODE	1-5 DIGITS	1234	

Console Programming Table

CHANGING A SENSORS SUPERVISION

- ◆ When a sensor is programmed, the Console automatically recognizes it as supervised or non-supervised.
- ◆ The Console expects hourly status transmissions from any sensor programmed as supervised.
- ◆ Any sensor can be programmed as supervised or non-supervised.

NOTE: Don't program a sensor that doesn't send status transmissions as supervised.

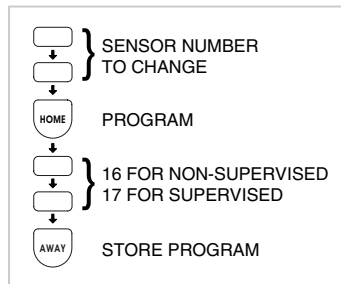

CHANGING A SENSORS RESTORE REQUIREMENTS

- ◆ When a sensor is programmed, the Console automatically recognizes it as manually or automatically restoring.
- ◆ The Console expects restoral signals from any sensor programmed as manual restore.
- ◆ Any sensor can be programmed as manual or automatic restore.

NOTE: Don't program a sensor that doesn't send restoral transmissions as manual restore.

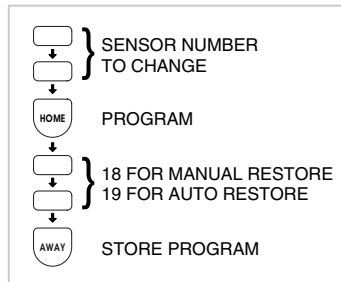

ENTRY DELAY TIME

- ◆ The factory-set Entry Delay time is 30 seconds.
- ◆ The Entry Delay time can be adjusted from 20 to 255 seconds.

NOTE: Don't make the Entry Delay too short. The user may not have enough time to disarm the system before an alarm.

- Write the new Entry Delay time in the User's Guide.

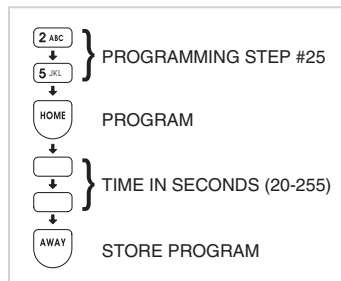

EXIT DELAY TIME

- ◆ The factory-set Exit Delay time is 60 seconds.
- ◆ The Exit Delay time can be adjusted from 20 to 255 seconds.

- Write the new Exit Delay time in the User's Guide.

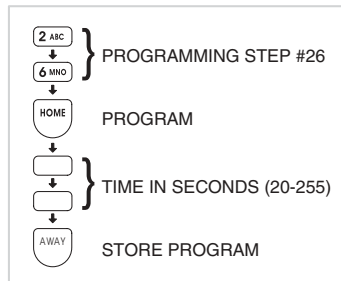

BURGLARY SIREN TIME

- ◆ The factory-set burglary siren time is five minutes (UL installation maximum).
- ◆ The burglary siren time can be adjusted from one to 30 minutes.

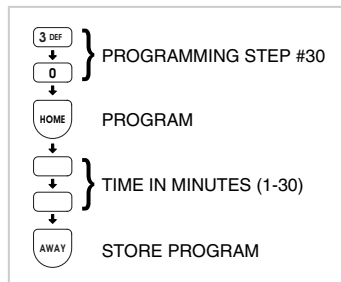

EMERGENCY SIREN TIME

- ◆ The factory-set emergency siren time is five minutes (UL installation maximum).
- ◆ The emergency siren time can be adjusted from one to 30 minutes.

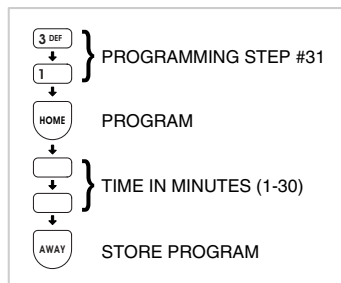

FIRE SIREN TIME

- ◆ The factory-set fire siren time is five minutes (UL installation maximum).
- ◆ The fire siren time can be adjusted from one to 30 minutes.

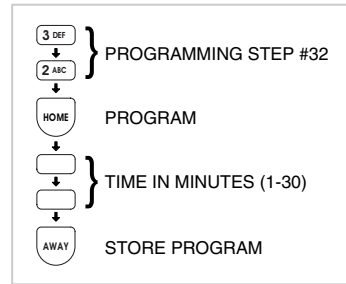

AUTOMATION OUTPUT TIME

- ◆ The factory setting causes the Automation Output to toggle between on and off with each activation.
- ◆ The Automation Output can be programmed to turn on, then automatically turn off after one to 2500 seconds (42 minutes).

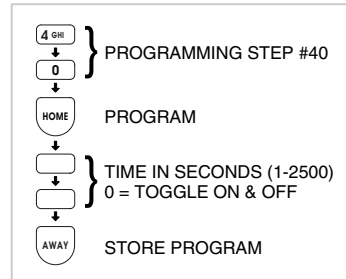

REMOTE CONTROL ARMING LEVEL

- ◆ The factory setting causes the portable remote controls to arm to the Away Mode.
- ◆ Alternately, the portable remote controls can arm to the Home Mode.
- ◆ Changing this setting will affect all the portable remote controls used with the system.

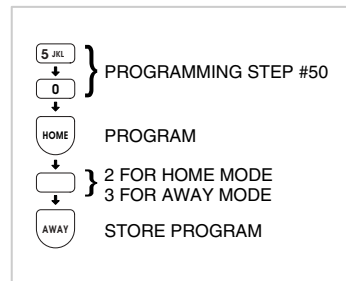

REMOTE CONTROL DISARMING LEVEL

- ◆ The factory setting causes the portable remote controls to disarm to the Off Mode.
- ◆ Alternately, the remote controls can disarm to the Chime Mode.
- ◆ Changing this setting will affect all the portable remote controls used with the system.

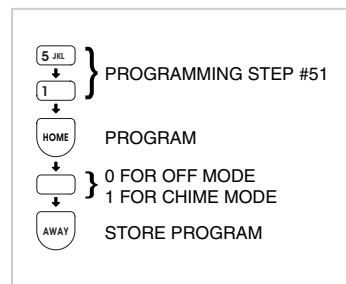

ENTRY DELAY BEEPS

- ◆ The factory setting causes the Console to beep during Entry Delays.
- ◆ Alternately, the Entry Delay beeps can be silenced.
- ◆ With the Entry Delay beeps off, the Console will be silent after a delayed sensor is triggered until the Entry Delay expires, then the alarm siren will sound.

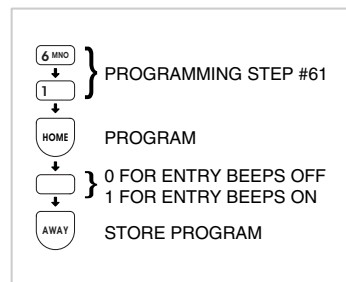

EXIT DELAY BEEPS

- ◆ The factory setting causes the Console to beep during Exit Delays.
- ◆ Alternately, the Exit Delay beeps can be silenced.
- ◆ With the Exit Delay beeps off, the Console will be silent after arming to the Away Mode until the Exit Delay expires, then a single “gong” tone will sound.

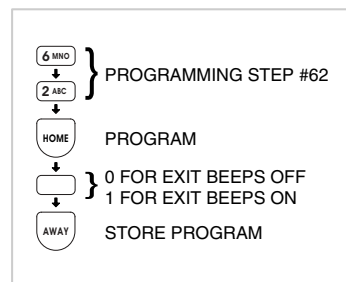

SILENT BURGLARY ALARMS

- ◆ The factory setting causes audible burglary alarms.
- ◆ Alternately, the Console can be programmed for silent burglary alarms.

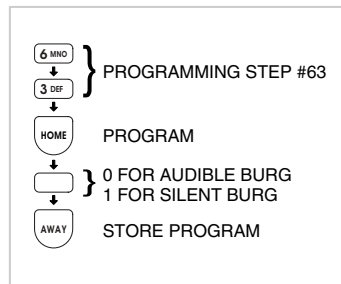

SILENT EMERGENCY ALARMS

- ◆ The factory setting causes audible emergency alarms.
- ◆ Alternately, the Console can be programmed for silent emergency alarms.

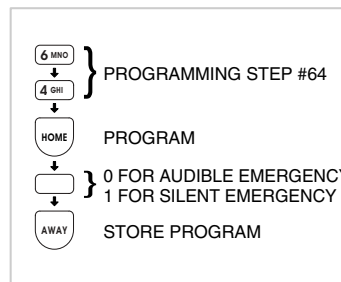

DISABLING QUICK ARMING

- ◆ The factory setting allows the Console to be armed by holding down the mode keys for two seconds.
- ◆ Alternately, the Console can be programmed to not allow quick arming.
- ◆ If quick arming is disabled, a user code *must* be entered before pressing the mode buttons.
- 🔧 **NOTE: For commercial installations, it is recommended to disable quick arming to prevent customers from arming the system.**
- 🔧 **NOTE: If quick arming is disabled the Home Instant Mode is unavailable.**

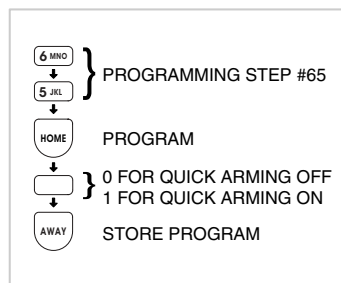

AUTOMATIC RESTORAL OF BYPASSED SENSORS

- ◆ Bypassed sensors are ignored by the Console and cannot cause an alarm.
- ◆ The factory setting causes the Console to automatically restore any bypassed sensor when the sensor closes. After it's restored, the sensor is ready to cause an alarm the next time it is opened.
- ◆ Alternately, the Console can be programmed to not automatically restore (remove the bypass from) sensors that close. Bypassed sensors will remain bypassed until the system is disarmed.

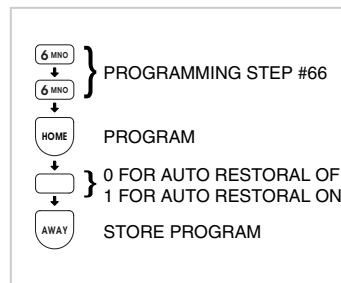

AUTOMATIC BYPASSING OF OPEN SENSORS

- ◆ The factory setting requires the user to manually bypass any open sensors when the system is armed.
- ◆ If arming is attempted with open sensors, the Console will sound five two-tone beeps and will not arm.
- ◆ Arming to the same mode again within five seconds will bypass any open sensors and arm the Console.
- ◆ Alternately, the Console can be programmed to automatically bypass any open sensors when the system is armed.

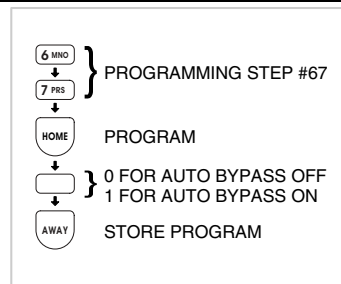

AUTOMATION OUTPUT MODE DURING ALARM

NOTE: For the Automation Output to activate during an alarm, that function must be enabled with Programming Step 71 or 72.

- ◆ If the Automation output is programmed to activate during an alarm, it can be programmed to flash or be steady.

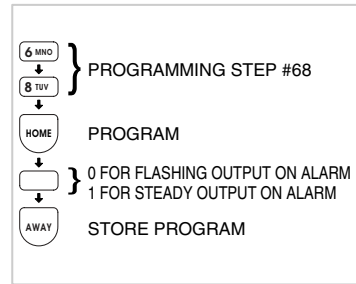

AUTOMATION ACTIVATION TONE

- ◆ The factory setting causes the Console to sound a “bing” when the Automation Output is activated by pressing the [(A)] key, or when it’s triggered with a two-button remote control.
- ◆ Alternately, this sound can be silenced.

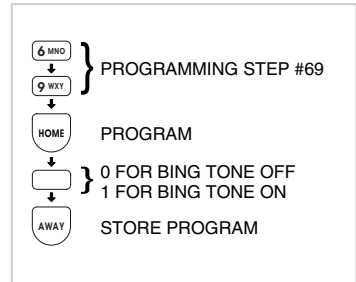

REMOTE CONTROL ARM/DISARM CHIRP

- ◆ When arming with the portable remote control, the factory setting causes the Console to “chirp” once when armed, twice when disarmed, and three times when arming with sensors bypassed.
- ◆ Alternately, these chirps can be silenced.

NOTE: If these chirps are silenced, it is recommended to program the Automation Output to be active when the system is armed, so a light can be triggered displaying the arming status of the Console.

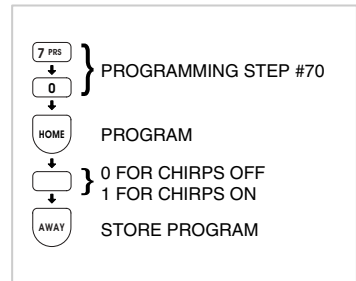

AUTOMATION OUTPUT FLASHES DURING AND AFTER ALARM

- ◆ The factory setting causes the Console’s Automation Output to activate when pressing the [(A)] key, or when it’s triggered with a two-button remote control.
- ◆ In addition, the Console can be programmed to flash the Automation Output during and after alarms.
- ◆ The output will continue to flash until the flashing status lights are cleared.

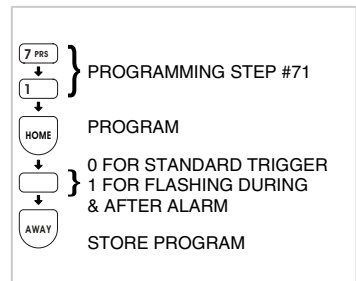

AUTOMATION OUTPUT ON DURING ALARM

- ◆ The factory setting causes the Console’s Automation Output to activate when pressing the [(A)] key, or when it’s triggered with a two-button remote control.
- ◆ In addition, the Console can be programmed to activate the Automation Output during alarms.

NOTE: The Automation Output can be programmed to flash or be steady during alarm, see Programming Step 68.

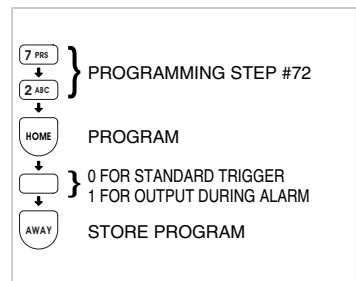

AUTOMATION OUTPUT WHILE ARMED

- ◆ The factory setting causes the Console’s Automation Output to activate when pressing the [(A)] key, or when it’s triggered with a two-button remote control.
- ◆ In addition, the Console can be programmed to activate the Automation Output when the system is armed.

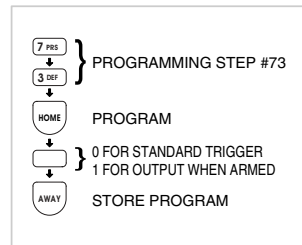

AUTOMATION OUTPUT DURING EXIT/ENTRY DELAYS

- ◆ The factory setting causes the Console’s Automation Output to activate when pressing the [(A)] key, or when it’s triggered with a two-button remote control.
- ◆ In addition, the Console can be programmed to activate the Automation Output during the exit and Entry Delays.

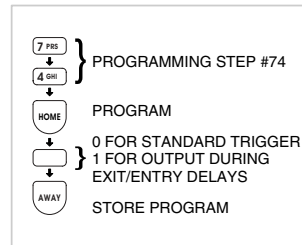

AUTOMATION OUTPUT POLARITY

- ◆ The factory setting causes the Console’s Automation Output to provide a current limited voltage source when activated.
- ◆ Alternately, the Console can be programmed so the Automation Output provides a current limited voltage source when *deactivated*.

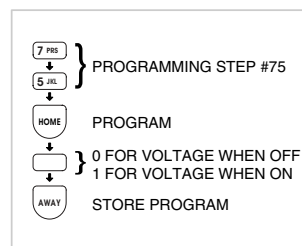

REMOTE ACCESS PASSWORD

- ◆ This is the password used to gain access to the Console when using the RA-2400 remote access software.
- ◆ The password must be 6-digits long.
- Log the remote access password in the box below.

REMOTE ACCESS PASSWORD

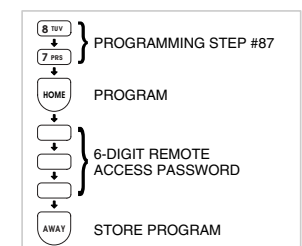

DURESS CODE

- ◆ The duress code will disarm the system, without any special indications or sounds, but will send the programmed duress code to the Central Station.
- ◆ The duress code should be **two or more digits different than any user code**.
- Log the duress code in the box below.

DURESS CODE

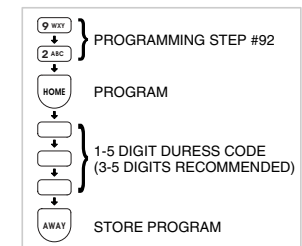

MASTER USER CODE

- ◆ The master user code is 1234 when power is first applied to the Console.
- ◆ The master user code can be changed through programming to any 1-5 digit code. Only the master user can access Setup Mode, restricted users cannot.
- NOTE: For maximum security, a 3-5 digit code is recommended.**
- Log the master user code in the box below.

MASTER USER CODE

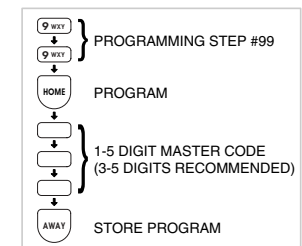

ADDITIONAL USER CODES

- ◆ The Console can be programmed with five restricted user codes and one page alert user code.
- ◆ The restricted user codes operate the system as usual, but cannot access Setup Mode.
- ◆ The restricted user codes can access a special Code Mode that can be used to change or remove any of the five restricted user codes, the page alert user code, or the duress code.
- ◆ The page alert user code dials the supervisory number (programmed for a pager) when it is used to arm or disarm the system.
- ◆ A restricted user code is a good one to give to children or any user that should be restricted from programming the Console.

🔧 **NOTE: For maximum security, a 3-5 digit code is recommended.**

🔧 **WARNING: NEVER PROGRAM ANY RESTRICTED OR PAGE ALERT USER CODE THE SAME AS THE MASTER USER CODE!**

- Log the restricted user codes in the boxes.

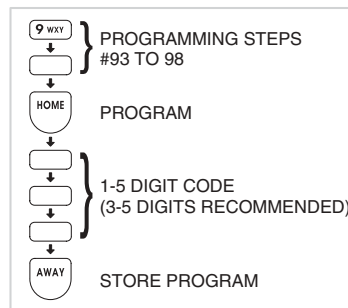

STEP # 93	RESTRICTED USER CODE #1	
STEP # 94	RESTRICTED USER CODE #2	
STEP # 95	RESTRICTED USER CODE #3	
STEP # 96	RESTRICTED USER CODE #4	
STEP # 97	RESTRICTED USER CODE #5	
STEP # 98	PAGE ALERT USER CODE	

REMOVING USER CODES

- ◆ Any restricted, duress or page alert user code can be removed from the Console.
- ◆ Because access to programming would be impossible without a master user code, it cannot be removed using these steps.
- ◆ The master user code can be changed using programming Step #99.

🔧 **NOTE: The master user code can be removed using the Console master reset, although all other system programming will be reset to factory values and all sensors programmed will be erased.**

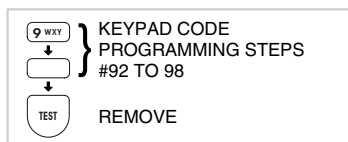

CONSOLE MASTER RESET

- ◆ Master resetting the Console will set all of the programming options back to the factory values. The master user code will be reset to 1234.

🔧 **CAUTION: Master resetting the Console will erase the user codes and remove all programmed sensors. All Console and communicator programming values will be reset to the factory defaults.**

- Start with the system in Test Mode (Setup Mode cannot be reached from any other mode).
- From the Test Mode, enter the master user code then press [TEST].
- * A “Gong” and five “Beeps” will sound, signaling that the system is in Setup Mode.
- Enter programming Step #999.
- Press [TEST].
- Enter the numbers 999 again.
- Press [TEST] again.
- * A “Bing” will sound to indicate the beginning of the reset process. This process will take up to 10 seconds while the memory is being reset.
- ◆ The system will revert to the first time power-up condition and the new master user code will be 1234. Go to the “Basic Console Programming” section of this manual to begin re-programming the system.

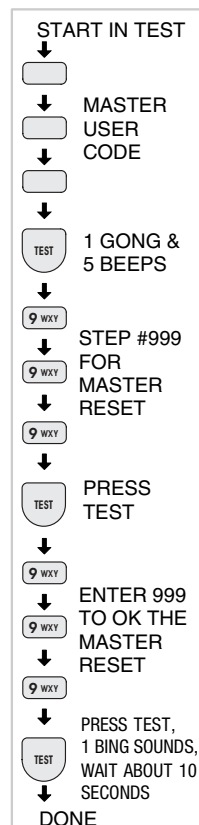

USE THESE EXACT KEYSTROKES TO PERFORM A MASTER RESET

13. COMMUNICATOR PROGRAMMING

SETUP MODE

- ◆ To perform any of the communicator programming steps, the Console must be in the Setup Mode.
- ◆ Each programming function is performed with similar keystrokes. After the Console is in Setup Mode, enter the programming step number, press the [HOME] key (HOME = program), enter the new value, and press the [AWAY] key (AWAY = store). Follow the figures next to the programming step.
- Start with the Console in Test Mode (Setup Mode cannot be reached from any other mode).
- From Test Mode, enter the master user code then press [TEST].
- 🔗 **NOTE: Only the master user code can be used to put the Console into the Setup Mode. The restricted user codes cannot access Setup Mode.**
- ✳ A “gong” and five “beeps” will sound, signaling that the Console is in Setup Mode.
- Hold the [OFF] key for three seconds when you want to exit Setup Mode.
- 🔗 **NOTE: If the Console is left unattended in Setup Mode, it will automatically switch back to Off Mode after three minutes.**

SETUP MODE

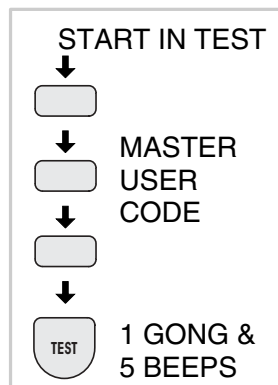

GENERAL COMMUNICATOR OPTIONS				
STEP #	PROGRAMMING FUNCTION	POSSIBLE VALUES	FACTORY VALUE	INSTALLATION VALUE
76	2-WAY AUDIO	0 = NONE; 1 = LISTEN; 2 = 2-WAY MANUAL; 3 = 2-WAY FULL DUPLEX	0	
78	VOICE RESPONSE FROM CONSOLE SPEAKER (AND REMOTE SPEAKER IF USED)	0 = VOICE RESPONSE DISABLED 1 = VOICE RESPONSE ENABLED	0	
100	REMOTE PROGRAMMING LOCKOUT	0 = UNLOCK; 1 = LOCK	0	
101	CALL LIMITER	0 = OFF; 1 = FIVE CALLS PER ARMING PERIOD	0	
103	DIALING DELAY	0 = NO DELAY; 1 = 30 SECOND DELAY	0	
104	DIALING METHOD	0 = TONE; 1 = PULSE	0	
107	COMMUNICATOR ENABLE	0 = COMMUNICATOR OFF, 1 = COMMUNICATOR ON	0	

General Communicator Programming Table

COMMUNICATOR ENABLE

- ◆ The factory setting for the Console disables the communicator. If the system is going to be a non-monitored, local alarm only, leave the communicator disabled.
- ◆ If the system is going to be monitored by a Central Station, enable the communicator with this programming step.

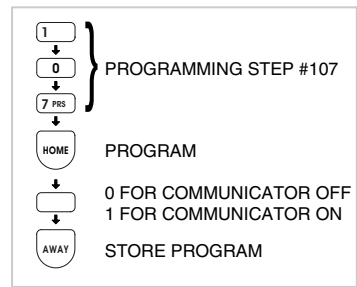

2-WAY AUDIO

- ◆ When the Model VB-2 voice module is installed, the communicator can provide 2-way audio capability.
- ◆ The audio module can be programmed for listen only, 2-way manual operation (using a pushbutton telephone at the Central Station), and 2-way full duplex hands free operation.
- ◆ Refer to the VB-2 installation instructions for details on operating the audio module.
- 📌 **NOTE: The Model VB-2 Digital Voice Synthesis module must be installed for this option to function.**
- ◆ The factory setting for the VB-2 audio module is OFF.
- ◆ Alternately, the audio module can be set for (1) listen-only, (2) 2-way manual, (3) 2-way full duplex.
- 📌 **NOTE: Units programmed for two-way duplex can still be controlled manually by pressing the "1" or "3" key. In addition, the Central Station can return the unit to two-way duplex by pressing the "8" key.**

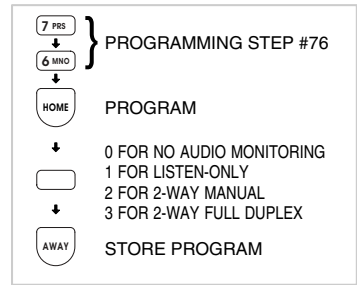

VOICE RESPONSE

- ◆ The Console can be programmed to allow its speaker to play audio produced by the VB-2 or VB-3 digital voice synthesis modules.
- ◆ This selection can also be used when a remote speaker is connected to the Console.
- ◆ The factory setting is to disable the Console's speaker from playing voice module audio.
- ◆ Alternately, the Console can be programmed to enable voice module audio.
- 📌 **NOTE: Turning voice response OFF with this programming step will only effect the audio produced by the voice module. It will not stop the Console's speaker from sounding local sirens and tones.**
- 📌 **NOTE: A Model VB-2 or VB-3 Digital Voice Synthesis module must be installed for this option to function.**

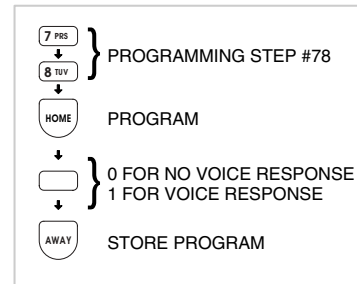

REMOTE LOCKOUT

- ◆ The factory setting for the communicator is to allow remote connection to the Console with Linear's RA-2400 Remote Access Software and a modem (unlocked).
- ◆ Alternately, the Console can be programmed to not answer incoming calls, thereby, not allowing remote access (locked).

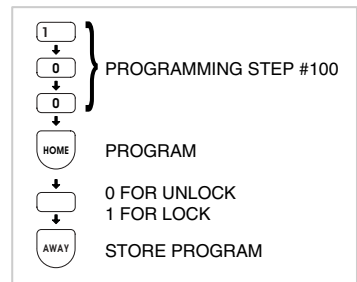

CALL LIMITER

- ◆ The factory setting for the call limiter is OFF. This allows the communicator to report burglary alarms, once for each sensor, as many times as they are triggered.
- ◆ Optionally, the Console can be programmed to only allow five burglary reports total per arming period.
- 🔧 **NOTE: Sensors programmed to 24-hour zones (Emergency, Panic, Fire) always send a Central Station Report and always sound the local siren regardless of the Call Limiter setting.**

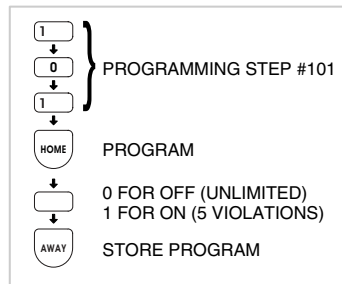

DIALING DELAY

- ◆ The factory setting will cause the communicator to dial the Central Station instantly when an alarm or supervisory event occurs.
- ◆ Alternately, the communicator can be programmed to wait 30 seconds before dialing. This gives the user time to disarm the system and prevent communications in the case of a subscriber generated false alarm.

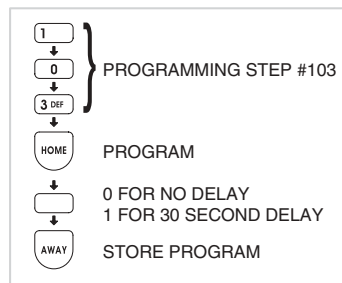

DIALING METHOD

- ◆ The factory setting causes the communicator to dial using DTMF (dual-tone multi-frequency) tone dialing.
- ◆ Alternately, the communicator can be programmed to use pulse (rotary) dialing. Use this option if the telephone line in the installation does not support tone dialing.

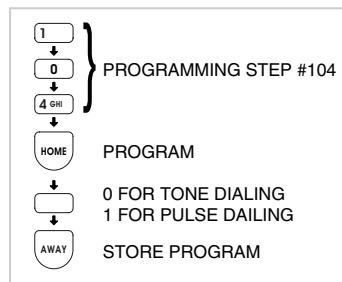

COMMUNICATOR REPORTING OPTIONS

REPORTING FORMAT

- ◆ The factory setting causes the communicator to report using the 4 by 2 format. This format allows four-digit account numbers from 0000 to 9999 and provides two-digit alarm codes.
- ◆ Alternately ADEMCO CONTACT ID can be chosen as a reporting format. This format allows 4-digit account numbers from 0000 to 9999 and provides verbose report descriptions with Ademco Contact ID compatible Central Stations.

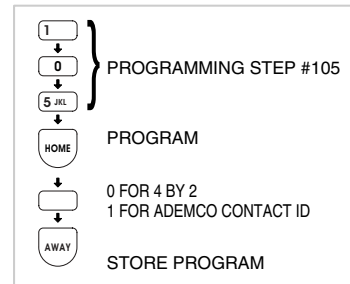

CALL ROUTING

- ◆ The factory setting for the communicator is to route all calls to the primary telephone number. If communication is unsuccessful after five attempts to the primary number, the secondary number will be dialed for an additional five attempts. If the secondary number cannot be reached, the communicator will “sleep” for five minutes before starting the call process over again. A total of five sleep cycles (50 call attempts) can occur before the communicator stops calling.
- ◆ Alternately, the communicator can be programmed to report supervisory events (low batteries, radio trouble, etc.) to the supervisory telephone number instead of the primary or secondary telephone numbers.
- ⚠ **CAUTION: If the page alert user code feature is going to be used, the supervisory number is reserved for the pager number. DO NOT SET THE CALL ROUTING OPTION TO “1”.**
- ◆ To disable supervisory reports, set call routing option to “1” and remove the supervisory telephone number or in 4 by 2 set the report to 0.
- ⚠ **NOTE: Do not program the primary and secondary telephone numbers the same. See the FCC Telephone Rules and Regulations on the rear cover of this manual.**

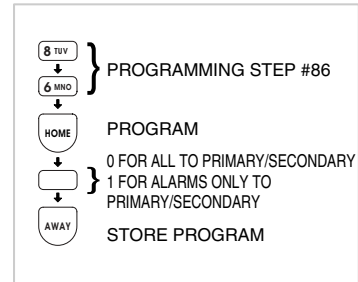

COMMUNICATOR REPORTING OPTIONS				
STEP #	PROGRAMMING FUNCTION	POSSIBLE VALUES	FACTORY VALUE	INSTALLATION VALUE
86	CALL ROUTING	0 = ALL CALLS TO PRIMARY OR SECONDARY NUMBER 1 = ALL ALARM CALLS TO PRIMARY OR SECONDARY NUMBER AND ALL OTHERS TO SUPERVISORY NUMBER	0	
88	ACCOUNT NUMBER	4 DIGITS	EMPTY	
89	PRIMARY PHONE NUMBER	UP TO 20 DIGITS	EMPTY	
90	SECONDARY PHONE NUMBER	UP TO 20 DIGITS	EMPTY	
91	SUPERVISORY/ PAGER PHONE NUMBER	UP TO 20 DIGITS	EMPTY	
	FOR ALL PHONE NUMBERS ⇒⇒⇒⇒	PRESSING THE (A) KEY INSERTS A 1-SECOND DELAY THE [FIRE] KEY INSERTS A 5-SECOND DELAY THE [CHIME] KEY INSERTS A “*” THE (A) KEY INSERTS A “#” IF IT IS THE LAST DIGIT OF THE PHONE NUMBER		
105	REPORTING FORMAT	0 = 4 BY 2; 1 = ADEMCO	0	
108	REPORT CONSOLE TROUBLE	0 = NO; 1 = YES	0	
110	REPORT FORCE ARMING	0 = NO; 1 = YES	0	
111	OPEN/CLOSE	0 = NO; 1 = YES; 2 = MASTER PAC ONLY	0	
113	POINT ID REPORTING FOR 4 BY 2 FORMAT	0 = NO; 1 = YES	1	

Communicator Reporting Option Table

ACCOUNT NUMBER

- ◆ The communicator's account number entered must be 4-digits long.
- ◆ The factory setting for the account number is 0000.
- ◆ Enter an account number from 0000 to 9999.

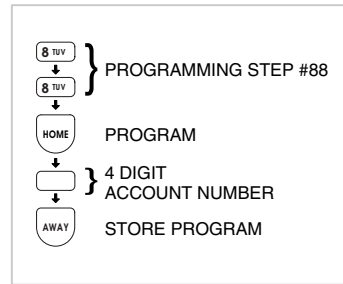

PRIMARY TELEPHONE NUMBER

- ◆ The primary Central Station telephone number can be up to 20-digits long.
- ◆ Digits 0-9 can be used.
- ◆ Delays and special characters can be entered in the telephone number (see below).

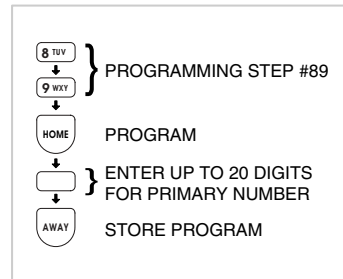

SECONDARY TELEPHONE NUMBER

- ◆ The secondary Central Station telephone number can be up to 20-digits long.
- ◆ Digits 0-9 can be used.
- ◆ Delays and special characters can be entered in the telephone number (see below).

NOTE: To remove the secondary telephone number, program Step # then press [TEST].

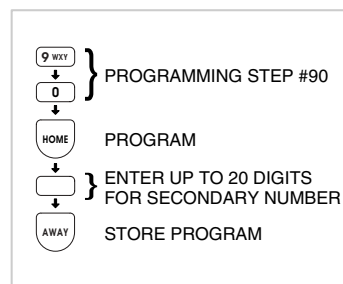

SUPERVISORY TELEPHONE NUMBER

- ◆ The supervisory Central Station telephone number can be up to 20-digits long.
- ◆ Digits 0-9 can be used.
- ◆ Delays and special characters can be entered in the telephone number (see below).

NOTE: To remove the supervisory telephone number, program Step # then press [TEST].

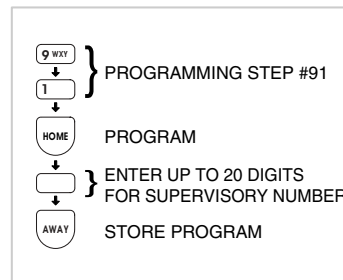

TELEPHONE NUMBER DELAYS AND SPECIAL CHARACTERS

- ◆ When creating telephone numbers with programming Steps 89, 90, & 91, use the following keys to add dialing delays or special characters.
- ◆ Press the (A) key to place a 1-second dialing delay at the start or anywhere in the middle of the telephone number.
- ◆ Pressing the (A) key as the last digit of the telephone number will place a pound (#) character at the end of the telephone number.
- ◆ Press the [FIRE] key to place a 5-second dialing delay anywhere in the telephone number.
- ◆ Press the [CHIME] key to place a star (*) character anywhere in the telephone number.

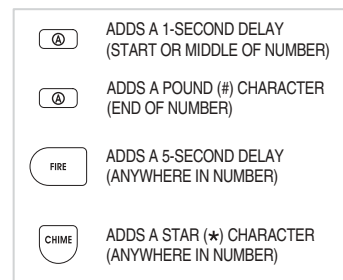

REPORT CONSOLE TROUBLE

- ◆ The factory setting does not report Console trouble events to the Central Station.
- ◆ Alternately, the communicator can be programmed to report Console trouble events. These include all conditions that light the Console’s BATTERIES or TROUBLE indicator. It also includes low Console backup battery.

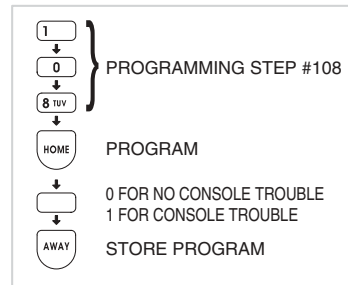

REPORT FORCE ARMING

- ◆ The factory setting does not send force arming reports.
- ◆ Alternately, the communicator can be programmed to report force arming anytime the Console is armed with one or more bypassed sensors.
- ◆ The factory set reporting code for force arming is “65” (Code 574 with Ademco).

NOTE: *If force arming is enabled, and the Console is force armed (armed with an open sensor) remotely by telephone, or with the RA-2400 Remote Access software, the caller will be disconnected if the communicator is enabled.*

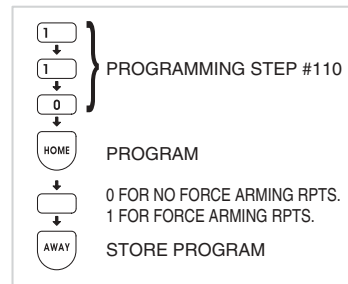

OPENING AND CLOSING REPORTS

- ◆ The factory setting does not send opening and closing reports
- ◆ Alternately, the communicator can be programmed to send an opening report when the system is disarmed, and a closing report when the system is armed for all users, or just the master user.

NOTE 1: *For commercial installations using opening and closing reports, it is recommended to disable quick arming to prevent customers from arming the system.*

NOTE 2: *The reporting codes are fixed for opening and closing. A unique code is reserved for the master user code and each of the five restricted user codes.*

NOTE 3: *Arming or disarming with the page alert user code dials the supervisory number, no opening or closing report is sent.*

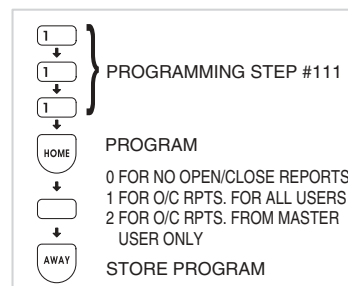

POINT ID REPORTING

- ◆ The factory setting enables Point ID and allows the communicator to send two-digit alarm and trouble codes for each sensor. The individual sensor that causes an alarm or trouble report can be identified at the Central Station.
- ◆ Alternately, Point ID can be disabled. The Central Station will only receive general alarm and trouble reports.

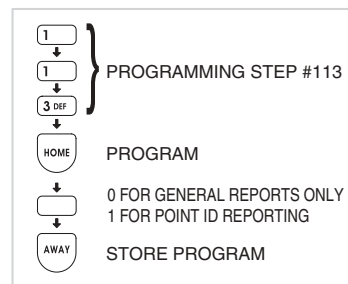

- ◆ The two-digit communicator reporting code for each event has a factory set value. These values may be customized to fit the specific installation and the reporting requirements of the Central Station monitoring the system.
- ◆ If Point ID reporting is enabled (the factory default setting), each sensor can report a unique alarm and trouble code.
- ◆ If Point ID is disabled, the “general” reporting codes for each event type will be used.
- ◆ Each programming function is performed with similar keystrokes. After the Console is in Setup Mode, enter the programming step number, press the [HOME] key (HOME = program), enter the new value, and press the [AWAY] key (AWAY = store).
- ◆ Making a value 0 causes event to not communicate to central station.

NOTE: The reporting codes are fixed for opening and closing. A unique code is reserved for the master and the five restricted user codes. See the Opening & Closing Reporting Codes Table.



GENERAL REPORTING CODES

- ◆ Program Steps #201 - 206 for the communicator reporting codes when Point ID is disabled.
- ◆ Refer to the Console & General Reporting Codes table to view/edit the reporting codes for each of the five events. The factory settings are listed, along with a blank area to write in the new installation values.
- ◆ Any value from 0-99 can be programmed for each event (0 = no report).

NOTE: Be careful not to duplicate codes unless the Central Station requires specific codes for certain types of events.

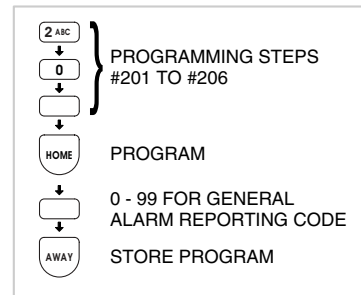

SYSTEM REPORTING CODES

- ◆ Program Steps #261 - 266 for the Console reporting codes.
- ◆ Refer to the System Reporting Codes table to view/edit the reporting codes for the keypad [FIRE] and [EMERGENCY] buttons and for each of the four Control Panel conditions. The factory settings are listed, along with a blank area to write in the new installation values.

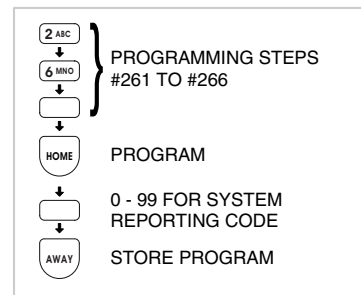

GENERAL REPORTING CODES				
STEP #	PROGRAMMING FUNCTION	POSSIBLE VALUES	FACTORY VALUE	INSTALLATION VALUE
201	GENERAL FIRE REPORT CODE	0 - 99	1	
202	GENERAL EMERGENCY REPORT CODE	0 - 99	2	
203	GENERAL SILENT PANIC REPORT CODE	0 - 99	3	
204	GENERAL BURGLARY REPORT CODE	0 - 99	4	
206	GENERAL TROUBLE REPORT CODE	0 - 99	6	

General Reporting Codes Table

FORCE ARMING REPORTING CODE

- ◆ Programming Step #258
- ◆ The factory set reporting code for force arming is “65” (Code 574 with Ademco).
- ◆ Any value from 0-99 can be programmed for this event (0 = no report).
- 📌 **NOTE: For force arming reporting, force arming reports must be enabled. See Page 37.**

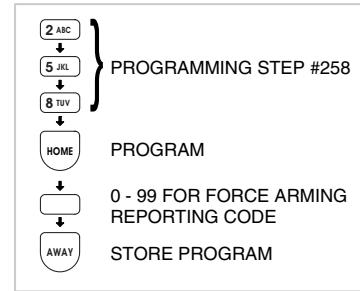

DURESS REPORTING CODE

- ◆ Programming Step #259
- ◆ The factory set reporting code for Duress is “66” (Code 121 with Ademco).
- ◆ Any value from 0-99 can be programmed for this event (0 = no report).
- 📌 **NOTE: For duress code reporting a keypad duress code must be programmed. See Page 30.**

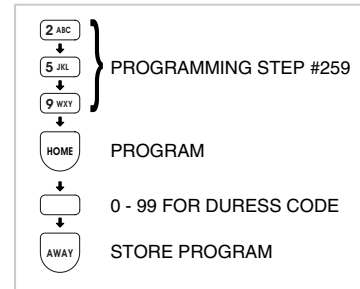

SYSTEM REPORTING CODES					
STEP #	PROGRAMMING FUNCTION	POSSIBLE 4 x 2 VALUES	FACTORY 4 x 2 VALUE	ADEMCO VALUE	INSTALLATION 4 x 2 VALUE
261	SYSTEM FIRE REPORT CODE	0 - 99	68	110	
262	SYSTEM EMERGENCY REPORT CODE	0 - 99	69	120	
263	SYSTEM TEST/CANCEL REPORT CODE	0 - 99	70	406	
264	SYSTEM LOW BATTERY RESTORAL REPORT CODE	0 - 99	71	R302	
266	SYSTEM LOW BATTERY REPORT CODE	0 - 99	73	E302	
258	FORCE ARMING REPORT CODE	0 - 99	65	574	
259	DURESS REPORT CODE	0 - 99	66	121	

System Reporting Codes Table

OPENING & CLOSING REPORTING CODES TABLE				
USER CODE	4 x 2 CLOSING (ARMING) CODE	4 x 2 OPENING (DISARMING) CODE	ADEMCO CLOSING (ARMING) CODE	ADEMCO OPENING (DISARMING) CODE
MASTER USER CODE	74	82	CLOSE U000	OPEN U000
RESTRICTED USER CODE #1	75	83	CLOSE U001	OPEN U001
RESTRICTED USER CODE #2	76	84	CLOSE U002	OPEN U002
RESTRICTED USER CODE #3	77	85	CLOSE U003	OPEN U003
RESTRICTED USER CODE #4	78	86	CLOSE U004	OPEN U004
RESTRICTED USER CODE #5	79	87	CLOSE U005	OPEN U005
PAGE ALERT USER CODE	(DIALS PAGE NUMBER ONLY, NO CODES REPORTED)			
REMOTE/HARDWIRE ARM (SENSOR TYPE 9) & QUICK ARM	81		R407 U007	
REMOTE/HARDWIRE DISARM (SENSOR TYPE 9)		89		E407 U007

Opening & Closing Reporting Codes Table

4 BY 2 FORMAT POINT ID ALARM REPORT CODES

◆ Refer to the 4 by 2 Format Point ID Reporting Code table to view/edit the alarm reporting codes for each of the 24 sensors. The communicator will send these codes if Point ID is enabled and any sensor triggers an alarm. The factory settings are listed, along with a blank area to write in the new installation values.

🔗 **NOTE: Be careful not to duplicate codes unless the Central Station requires specific codes for certain types of sensors.**

◆ Each programming function is performed with similar keystrokes. After the system is in Setup Mode, enter the programming step number, press the [HOME] key (HOME = program), enter the new value, and press the [AWAY] key (AWAY = store).

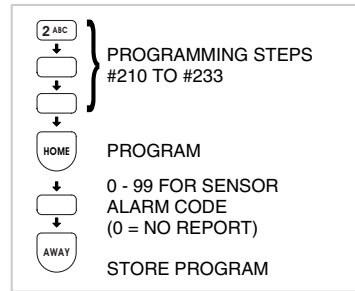

4 BY 2 FORMAT POINT ID TROUBLE REPORT CODES

◆ Refer to the 4 by 2 Format Point ID Reporting Code table to view/edit the trouble reporting codes for each of the 24 sensors. The communicator will send these codes if Point ID is enabled and any sensor has a low battery or trouble condition. The factory settings are listed, along with a blank area to write in the new installation values.

🔗 **NOTE: Be careful not to duplicate codes unless the Central Station requires specific codes for certain types of sensors.**

◆ Each programming function is performed with similar keystrokes. After the Console is in Setup Mode, enter the programming step number, press the [HOME] key (HOME = program), enter the new value, and press the [AWAY] key (AWAY = store).

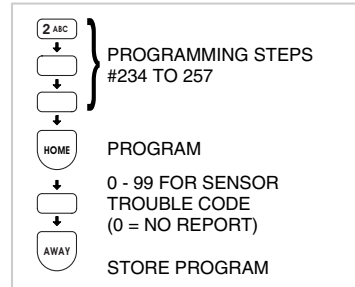

POINT ID REPORTING CODES

STEP #	PROGRAMMING FUNCTION	POSSIBLE VALUES	FACTORY VALUE	INSTALLATION VALUE
210	SENSOR 1 ALARM REPORT CODE	0 - 99	11	
211	SENSOR 2 ALARM REPORT CODE	0 - 99	12	
212	SENSOR 3 ALARM REPORT CODE	0 - 99	13	
213	SENSOR 4 ALARM REPORT CODE	0 - 99	14	
214	SENSOR 5 ALARM REPORT CODE	0 - 99	15	
215	SENSOR 6 ALARM REPORT CODE	0 - 99	16	
216	SENSOR 7 ALARM REPORT CODE	0 - 99	17	
217	SENSOR 8 ALARM REPORT CODE	0 - 99	18	
218	SENSOR 9 ALARM REPORT CODE	0 - 99	19	
219	SENSOR 10 ALARM REPORT CODE	0 - 99	20	
220	SENSOR 11 ALARM REPORT CODE	0 - 99	21	
221	SENSOR 12 ALARM REPORT CODE	0 - 99	22	
222	SENSOR 13 ALARM REPORT CODE	0 - 99	23	
223	SENSOR 14 ALARM REPORT CODE	0 - 99	24	
224	SENSOR 15 ALARM REPORT CODE	0 - 99	25	
225	SENSOR 16 ALARM REPORT CODE	0 - 99	26	
226	SENSOR 17 ALARM REPORT CODE	0 - 99	27	
227	SENSOR 18 ALARM REPORT CODE	0 - 99	28	
228	SENSOR 19 ALARM REPORT CODE	0 - 99	29	
229	SENSOR 20 ALARM REPORT CODE	0 - 99	30	
230	SENSOR 21 ALARM REPORT CODE	0 - 99	31	
231	SENSOR 22 ALARM REPORT CODE	0 - 99	32	
232	SENSOR 23 ALARM REPORT CODE	0 - 99	33	
233	SENSOR 24 ALARM REPORT CODE	0 - 99	34	
234	SENSOR 1 TROUBLE REPORT CODE	0 - 99	41	
235	SENSOR 2 TROUBLE REPORT CODE	0 - 99	42	
236	SENSOR 3 TROUBLE REPORT CODE	0 - 99	43	
237	SENSOR 4 TROUBLE REPORT CODE	0 - 99	44	
238	SENSOR 5 TROUBLE REPORT CODE	0 - 99	45	
239	SENSOR 6 TROUBLE REPORT CODE	0 - 99	46	
240	SENSOR 7 TROUBLE REPORT CODE	0 - 99	47	
241	SENSOR 8 TROUBLE REPORT CODE	0 - 99	48	
242	SENSOR 9 TROUBLE REPORT CODE	0 - 99	49	
243	SENSOR 10 TROUBLE REPORT CODE	0 - 99	50	
244	SENSOR 11 TROUBLE REPORT CODE	0 - 99	51	
245	SENSOR 12 TROUBLE REPORT CODE	0 - 99	52	
246	SENSOR 13 TROUBLE REPORT CODE	0 - 99	53	
247	SENSOR 14 TROUBLE REPORT CODE	0 - 99	54	
248	SENSOR 15 TROUBLE REPORT CODE	0 - 99	55	
249	SENSOR 16 TROUBLE REPORT CODE	0 - 99	56	
250	SENSOR 17 TROUBLE REPORT CODE	0 - 99	57	
251	SENSOR 18 TROUBLE REPORT CODE	0 - 99	58	
252	SENSOR 19 TROUBLE REPORT CODE	0 - 99	59	
253	SENSOR 20 TROUBLE REPORT CODE	0 - 99	60	
254	SENSOR 21 TROUBLE REPORT CODE	0 - 99	61	
255	SENSOR 22 TROUBLE REPORT CODE	0 - 99	62	
256	SENSOR 23 TROUBLE REPORT CODE	0 - 99	63	
257	SENSOR 24 TROUBLE REPORT CODE	0 - 99	64	

Point ID Reporting Codes Table

IMPORTANT INFORMATION

LINEAR LIMITED WARRANTY

This Linear product is warranted against defects in material and workmanship for twelve (12) months. The Warranty Expiration Date is labeled on the product. **This warranty extends only to wholesale customers** who buy direct from Linear or through Linear's normal distribution channels. **Linear does not warrant this product to consumers.** Consumers should inquire from their selling dealer as to the nature of the dealer's warranty, if any. **There are no obligations or liabilities on the part of Linear Corporation for consequential damages arising out of or in connection with use or performance of this product or other indirect damages with respect to loss of property, revenue, or profit, or cost of removal, installation, or reinstallation.** All implied warranties, including implied warranties for merchantability and implied warranties for fitness, are valid only until Warranty Expiration Date as labeled on the product. **This Linear Corporation Warranty is in lieu of all other warranties express or implied.**

All products returned for warranty service require a Return Product Authorization Number (RPA#). Contact Linear Technical Services at 1-800-421-1587 for an RPA# and other important details.

WIRELESS PRODUCT NOTICE

Linear radio controls provide a reliable communications link and fill an important need in portable wireless signaling. However, there are some limitations which must be observed.

- * For U.S. installations only: The radios are required to comply with FCC Rules and Regulations as Part 15 devices. As such, they have limited transmitter power and therefore limited range.
- * A receiver cannot respond to more than one transmitted signal at a time and may be blocked by radio signals that occur on or near their operating frequencies, regardless of code settings.
- * Changes or modifications to the device may void FCC compliance.
- * Infrequently used radio links should be tested regularly to protect against undetected interference or fault.
- * A general knowledge of radio and its vagaries should be gained prior to acting as a wholesale distributor or dealer, and these facts should be communicated to the ultimate users.

FCC NOTICE

This equipment generates and uses radio frequency energy and if not installed and used properly, that is, in strict accordance with the manufacturer's instructions, may cause interference to radio and television reception. It has been type tested and found to comply with the limits for a Class B computing device in accordance with Part 15 of FCC Rules, which are designed to provide reasonable protection against such interference in a residential installation. However, there is no guarantee that interference will not occur in a particular installation. If this equipment does cause interference to radio or television reception, which can be determined by turning the equipment off and on, the user is encouraged to try to correct the interference by one or more of the following measures:

- * Relocate the Console away from the TV/radio receiver.
- * Plug the Console into a different wall outlet so that the Console is on a different branch circuit.
- * Re-orient the TV/radio antenna.
- * If necessary, the user should consult the dealer or an experienced radio/television technician for additional suggestions.

FCC TELEPHONE RULES AND REGULATIONS

The FCC requires that this alarm dialer system not make more than 15 repetitive dialing attempts to a single telephone number. There are no limitations when the calls are made sequentially to two or more alternative numbers, or when these calls are spaced 10 minutes apart to a single number. The FCC Rules and Regulations do not specify the re-attempt period as this can vary for specific applications. When setting this period, take into consideration local, interstate, foreign and special network call completion characteristics, network processing time, a sufficient number of rings and busy/don't answer modes.

FIRE EVACUATION PLANNING

For systems that include fire protection, UL requires that the following information be available to the users of the system.

- * Draw up a floor plan showing two exits for each room.

The following procedures are to be discussed with the family:

- ① Status of bedroom doors.
- ② Familiarity with alarm signals.
- ③ Testing of door during a fire and use of alternate escape route if door is hot to touch.
- ④ Crawling and holding breath.
- ⑤ Escape fast. No stopping for packing.
- ⑥ Meet at designated outdoor spot.
- ⑦ Emphasize that no one is to return to a burning house.
- ⑧ Fire department notification from a neighbor's phone.
- ⑨ Periodic rehearsal is to be conducted.

INDUSTRY CANADA NOTICES

NOTICE: The ringer equivalence number (REN) assigned to each terminal device provides an indication of the maximum number of terminals allowed to be connected to a telephone interface. The termination on an interface may consist of any combination of devices subject only to the requirement that the sum of the ringer equivalence numbers of all the devices does not exceed 5.

NOTICE: The Industry Canada label identifies certified equipment. This certification means that the equipment meets certain telecommunications network protective, operational and safety requirements. The Department does not guarantee the equipment will operate to the user's satisfaction.

Before installing this equipment, users should ensure that it is permissible to be connected to the facilities of the local telecommunications company. The equipment must also be installed using an acceptable method of connection. The customer should be aware that compliance with the above conditions may not prevent degradation of service in some situations.

Repairs to certified equipment should be made by an authorized Canadian maintenance facility designated by the supplier. Any repairs or alterations made by the user to this equipment, or equipment malfunctions, may give the telecommunications company cause to request the user to disconnect the equipment.

Users should ensure for their own protection that the electrical ground connections of the power utility, telephone lines and internal metallic water pipe system, if present, are connected together. This precaution may be particularly important in rural areas.

CAUTION: Users should not attempt to make such connections themselves, but should contact the appropriate electric inspection authority, or electrician, as appropriate.