



**HOME AUTOMATION, INC.**

**Omni**

# **Installation Manual**

**Document Number 10I00-1 Rev A  
February, 1998**

**Home Automation, Inc.**

*Omni*

**Installation Manual**

**Document Number 10I00-1 Rev A  
February, 1998  
Copyright © 1998 Home Automation, Inc.  
All Rights Reserved**

## TABLE OF CONTENTS

<b>INTRODUCTION</b>	<b>4</b>
<b>PLANNING</b>	<b>4</b>
<b>INSTALLATION</b>	<b>5</b>
CONTROLLER HOOKUP	5
ABOUT SECURITY ZONES	7
BURGLAR ZONE HOOKUPS	7
FIRE ZONE HOOKUP	7
TELEPHONE CONNECTIONS	10
LCD CONSOLE HOOKUP	12
CONSOLE SETUP	12
CONSOLE SELF TEST	13
SOUNDER OUTPUTS	15
INTERIOR SOUNDER HOOKUP	15
EXTERIOR SOUNDER HOOKUP	16
CONTROLLER OUTPUTS	17
REMOTE ARM/DISARM SWITCH	18
HOME CONTROL MODULES	18
PROGRAMMABLE ENERGY SAVER MODULES	20
OUTDOOR TEMPERATURE, TEMPERATURE SENSORS	21
<b>SYSTEM POWER-UP PROCEDURE</b>	<b>23</b>
CONSOLE CHECK OUT	23
TELEPHONE CHECK OUT	24
BURGLAR ZONE CHECK OUT	24
FIRE ZONE CHECK OUT	25
HOME CONTROL CHECK OUT	25
CUSTOMER CHECK OUT	26
IN CASE OF TROUBLE	26
X-10 TROUBLESHOOTING TIPS	28
<b>DIGITAL COMMUNICATOR</b>	<b>29</b>
DESCRIPTION OF 4/2 FORMAT	29
3/1 FORMAT	30
OPENING AND CLOSING REPORTS	30
<b>INSTALLER SETUP</b>	<b>31</b>
<b>SETUP CONTROL</b>	<b>31</b>
<b>SETUP ZONES</b>	<b>33</b>
ZONE TYPES	34
DESCRIPTION OF ZONE TYPES	35

<b>SETUP DIGITAL COMMUNICATOR</b>	<b>38</b>
FIRST PHONE, ACCOUNT NUMBER	38
SECOND PHONE, ACCOUNT NUMBER	38
COMMUNICATOR TYPE	38
TWO-WAY AUDIO	39
REPORT OPEN/CLOSE	39
AUTOMATIC TEST TIME	39
ALARM CODES	39

<b>SETUP AREAS</b>	<b>40</b>
SETUP AREAS: CONTROL	40
SETUP AREAS: ZONES	41
SETUP AREAS: BUTTONS	41
SETUP AREAS: CONSOLES	42
SETUP AREAS: THERMOSTATS	43

<b>SETUP TEMPERATURES</b>	<b>43</b>
---------------------------	-----------

<b>SETUP MISCELLANEOUS</b>	<b>44</b>
----------------------------	-----------

<b>SETUP EXPANSION</b>	<b>49</b>
------------------------	-----------

<b>OMNI SPECIFICATIONS</b>	<b>51</b>
----------------------------	-----------

<b>UNDERWRITER'S LABORATORIES (UL)</b>	
<b>INSTALLATION REQUIREMENTS</b>	<b>52</b>

<b>SMOKE DETECTOR INSTALLATION GUIDELINES</b>	<b>55</b>
---	-----------

## **FIGURES**

FIG 1. CONTROLLER HOOKUP	6
FIG 2. OVERALL CONNECTIONS DIAGRAM	8
FIG 3. FIRE ZONE CONNECTIONS	9
FIG 4. RJ31X JACK CONNECTIONS	11
FIG 5. CONSOLE CONNECTIONS	14
FIG 6. INTERIOR SOUNDER CONNECTION	15
FIG 7. EXTERIOR SOUNDER CONNECTIONS	16
FIG 8. REMOTE KEYSWITCH CONNECTION	19
FIG 9. MODEL 1101 PESM CONNECTIONS	22
FIG 10. 24 HR STANDBY CONNECTIONS	54

## **APPENDIX**

PLANNING/INSTALLATION CHECKLIST	A
---------------------------------	---



## INTRODUCTION

This installation guide is intended as an aid to installing the Omni Home Automation System. The installer should also have thoroughly reviewed and understood the Omni Owner's Manual, which has important information regarding final setup of the system. This manual assumes that the installer has a basic understanding of installing a security system.

This guide applies to both 10A00-1 and -4 versions of the Omni series controller. Refer to the Underwriters Laboratories Installation Requirements section for details in the application of each. Failure to install the Omni and its accessories in accordance with the UL Requirements in this manual and in the Owner's Manual, is a violation of the Listing Mark.

## PLANNING

Before you start, your system should be planned. The INSTALLATION PLANNER/CHECKLIST at the end of this manual serves two purposes: First, to help you plan out your system, and second, to perform a final check out once installation is complete.

Use the PLANNER/CHECKLIST as follows:

1. Zones:

- Decide where each contact or detector will be located
- Decide which zone it will occupy
- Decide zone type for each zone
- Decide what area will be assigned
- With the customer, decide what text and voice descriptors will be used. Consult table of voice descriptors, so that you can choose similar words for the text to avoid customer confusion.
- Write each contact location on the line under the appropriate zone on the PLANNER/CHECKLIST
- See SMOKE DETECTOR INSTALLATION GUIDELINES to plan locations for smoke detectors

2. Consoles:

Consult the customer on the console location. The console should be easily accessible. Write the console location(s) on the planning sheet.

3. Interior Sounder and Outside Siren:

Locate both where they cannot be tampered with.

4. Home Control Modules:

Keep in mind that the Omni default settings for FLASH FOR ALARM is Unit Number 2 - make that the front porch light.

5. Plan for thermostats, energy saver modules, or other options.
6. Give consideration to where the controller will go. Remember that it needs an unswitched, duplex receptacle, preferably on its own circuit, within 5 feet of the controller.

## **INSTALLATION**

1. Go over your plan with your customer.
2. Install the entire system. Refer to sections in this manual to see how to install various components.
3. Follow the Power-Up and Checkout procedures.
4. Explain the basics to the customer. Deliver all manuals and documentation.
5. Pick up trash, tools, and payment.
6. Follow up with your customer to keep them satisfied.

## **CONTROLLER HOOKUP**

1. When choosing a place to mount the controller, consider the following:
  - A. A duplex outlet, preferably on its own circuit, is required to be within 5 feet of the controller for the power transformer and the X-10 Control Module.
  - B. The controller should be protected from weather, temperature extremes, and burglars.
  - C. The controller makes a faint hissing sound during normal operation. It may not be suitable for mounting in a quiet bedroom.
2. GROUND THE CONTROLLER "EARTH GND" TERMINAL TO A COLD WATER PIPE OR TO A 4 FOOT GROUND ROD TO PRESERVE ITS BUILT-IN TRANSIENT PROTECTION. USE 14 GAUGE WIRE. TRANSIENT PROTECTION WILL NOT WORK IF THE CONTROLLER IS NOT PROPERLY GROUNDED.
3. Connect the 24 VAC power transformer to the 24 VAC INPUT terminals.
4. Connect the BLACK battery wire to the minus (-) terminal on the battery. DO NOT connect the red wire at this time. DO NOT reverse the connections; the battery fuse will blow. Note that the unit will NOT START on the battery alone. AC power must be applied to engage the low voltage cut out relay. After that, the system will run on the battery without AC power.
5. Plug the X-10 USA Powerline Interface Module into the outlet above the transformer. Use the supplied 4 conductor modular telephone cable to connect the module to the jack on the processor board. DO NOT ATTEMPT TO LENGTHEN THIS CABLE! The X-10 modules may not work! The red LED on the interface module should be on and will blink off when the interface receives a signal from the controller.
6. Refer to **FIGURE 1 (CONTROLLER HOOKUP)** for this configuration.

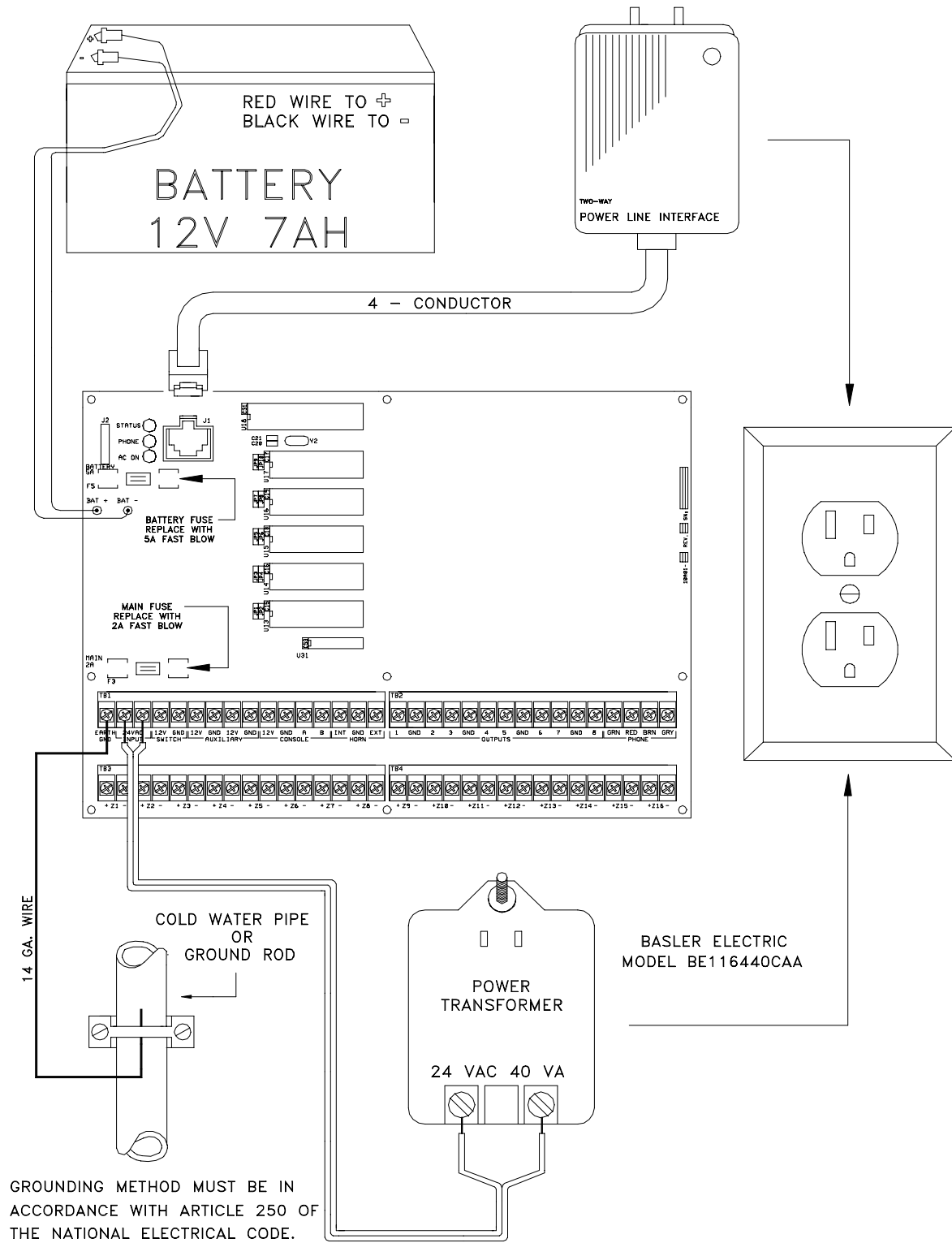

**FIGURE 1**  
**CONTROLLER HOOKUP**



## ABOUT SECURITY ZONES

Each of the 16 security zone inputs in an Omni may be configured as a burglary zone, a fire zone, a temperature zone, or an auxiliary input. Zones 9-16 may also be configured as a PESM. The zone type for each zone is selected through the Omni SETUP menu on the console or by using the PC ACCESS software.

The system supports a maximum zone resistance, excluding the end-of-line resistor, of 150 ohms.

The default settings for all zone inputs on an Omni controller are configured as Auxiliary inputs.

## BURGLAR ZONE HOOKUPS

The Omni system supports both normally open and normally closed switches . Most contacts designed for doors, windows, motion detectors, glassbreak detectors and other security devices meet this requirement. An external 1000 ohm end-of-line resistor must be used for all burglary zones.

1. When using a normally open switch, a 1000 ohm end-of-line resistor must be in parallel with the zone being used. Maximum loop resistance excluding end-of-line resistor should not exceed 150 ohms.
2. When using a normally closed switch, a 1000 ohm end-of-line resistor must be put in series with the zone being used. Maximum loop resistance excluding end-of-line resistor should not exceed 150 ohms.
3. Power motion detectors from AUX 12VDC.
4. Unused zones may be left open, and should be left at the default setting of AUXILIARY zone types.
5. Use normally open or normally closed panic switches with a 1000 ohm end-of-line resistor.
6. See **FIGURE 2 (OVERALL CONNECTIONS DIAGRAM)** for configurations of burglary zones.

## FIRE ZONE HOOKUP

The Omni system supports normally open (closed for alarm), four-wire smoke detectors. An external 1000 ohm end-of-line resistor must be used for all fire zones.

1. Use normally open (closed for alarm) 4 wire 'SYSTEM' type smoke detectors, ESL Model 445AT or equivalent, rated 8 - 14 VDC.
2. Power smoke detectors from SWITCH +12 VDC.
3. End of line resistor: 1000 ohms. Maximum loop resistance excluding end of line resistor is 150 ohms. Use HAI Model 1503A0011 End Of Line Resistor Assembly in UL Listed Installations.
4. End of Line Relay Module (ESL Model 204B or equiv.) required for UL installations.
5. Refer to **FIGURE 3 (FIRE ZONE CONNECTIONS)** for this configuration.

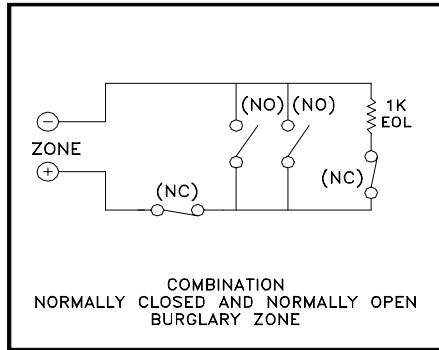
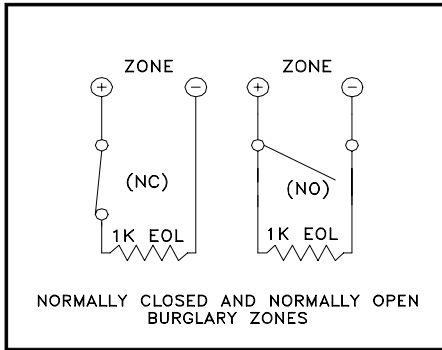

**NOTE:**

SWITCH 12V, AUXILIARY 12V, CONSOLE, AND OUTPUTS 1-8 ARE INCLUDED IN THE TOTAL DEVICE LOAD, WHICH CANNOT EXCEED 1 AMP. SOUNDERS CAN DRAW UP TO 1 AMP MAXIMUM, SPLIT BETWEEN INTERIOR AND EXTERIOR HORN OUTPUTS.

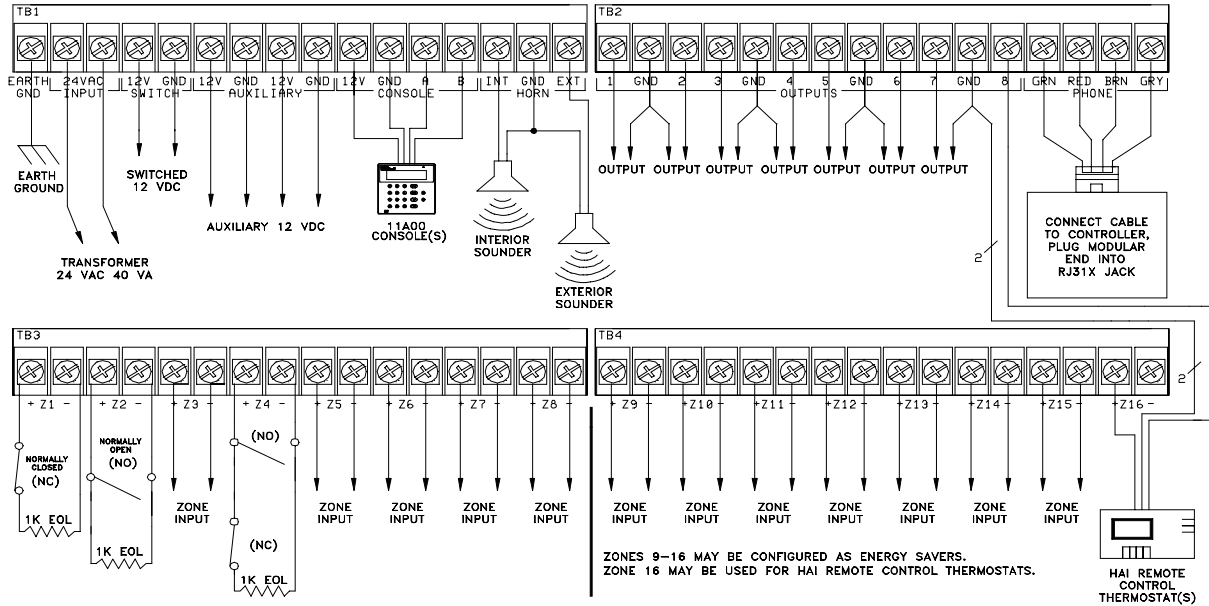

**FIGURE 2**  
**OVERALL CONNECTIONS DIAGRAM**

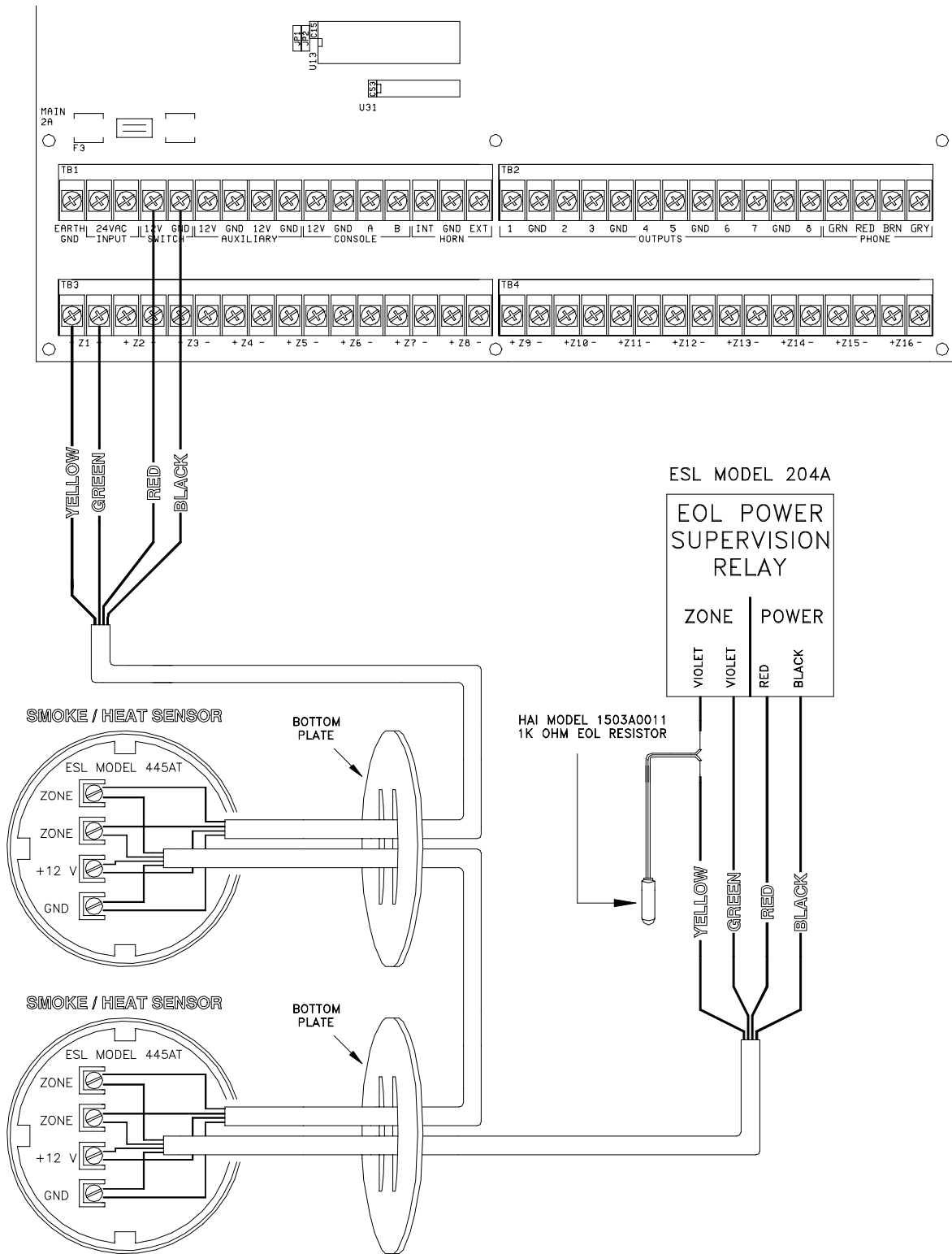

**FIGURE 3**  
**FIRE ZONE CONNECTIONS**

## TELEPHONE CONNECTIONS

1. If an RJ31X jack has been supplied by the telephone company, it is probably wired correctly and the controller can be connected by plugging the supplied 8 conductor telephone cable into the RJ31X jack. The other end of the cable is spaded. The green, red, brown, and gray wires must be connected to the controller at the designated terminals under the section of the board marked 'PHONE'.
2. If required, install the supplied RJ31X jack as shown in the following diagram. The polarity must be correct for proper operation of the phone access feature.
3. IT IS IMPERATIVE THAT THE PHONE LINE COMING INTO THE HOUSE BE CONNECTED TO A GROUNDED SURGE ARRESTOR OUTSIDE THE PREMISES. IT IS THE RESPONSIBILITY OF THE TELEPHONE COMPANY TO PROVIDE THIS SURGE ARRESTOR.

INSPECT THE INCOMING PHONE LINES. THE FIRST THING THAT THEY SHOULD GO TO IS A SMALL BOX ON THE OUTSIDE OF THE PREMISES. THERE SHOULD BE A HEAVY GROUND WIRE COMING FROM THIS BOX GOING TO A COLD WATER PIPE OR A SEPARATE GROUNDING ROD.

IF THERE IS NO SURGE ARRESTOR OR IF THE GROUND WIRE IS MISSING, HAVE THE CUSTOMER INSIST THAT THE TELEPHONE COMPANY INSTALL ONE FOR THE SAFETY OF THE CUSTOMER.

4. WHEN WIRING A RJ31X JACK, MAKE SURE THAT THE INCOMING PHONE LINES GO TO THE TELEPHONE COMPANY SURGE ARRESTOR BEFORE THEY GO TO THE RJ31X JACK.
5. When the RJ31X is installed as shown, locate the green, red, brown, and gray spaded wires from the 8 conductor phone cable and connect to the section on the Omni controller marked 'PHONE'. Plug the modular end of the cable into the RJ31X jack. If necessary, bend the tab up on the plug to ensure a tight fit that will not fall out.
6. Verify the following if you have trouble during check out: With the system running, the RJ31X jack properly connected and all phones on-hook (hung up), the PHONE LINE LED, located in the upper left corner of the controller, should be OFF. If it is on, reverse the RED and GREEN wires to both the house phones and the telephone company wires at the RJ31X jack. When the receiver is picked up on any phone, the PHONE LINE LED will come on. When the phone line rings, the PHONE LINE LED will light.

If the Omni is accessed on an in house telephone, the Omni will disconnect the phones from the phone company lines and supply its own talk voltage to the phones. The PHONE LINE LED will be on in this case.

7. Refer to **FIGURE 4 (RJ31X JACK CONNECTIONS)** for this configuration.

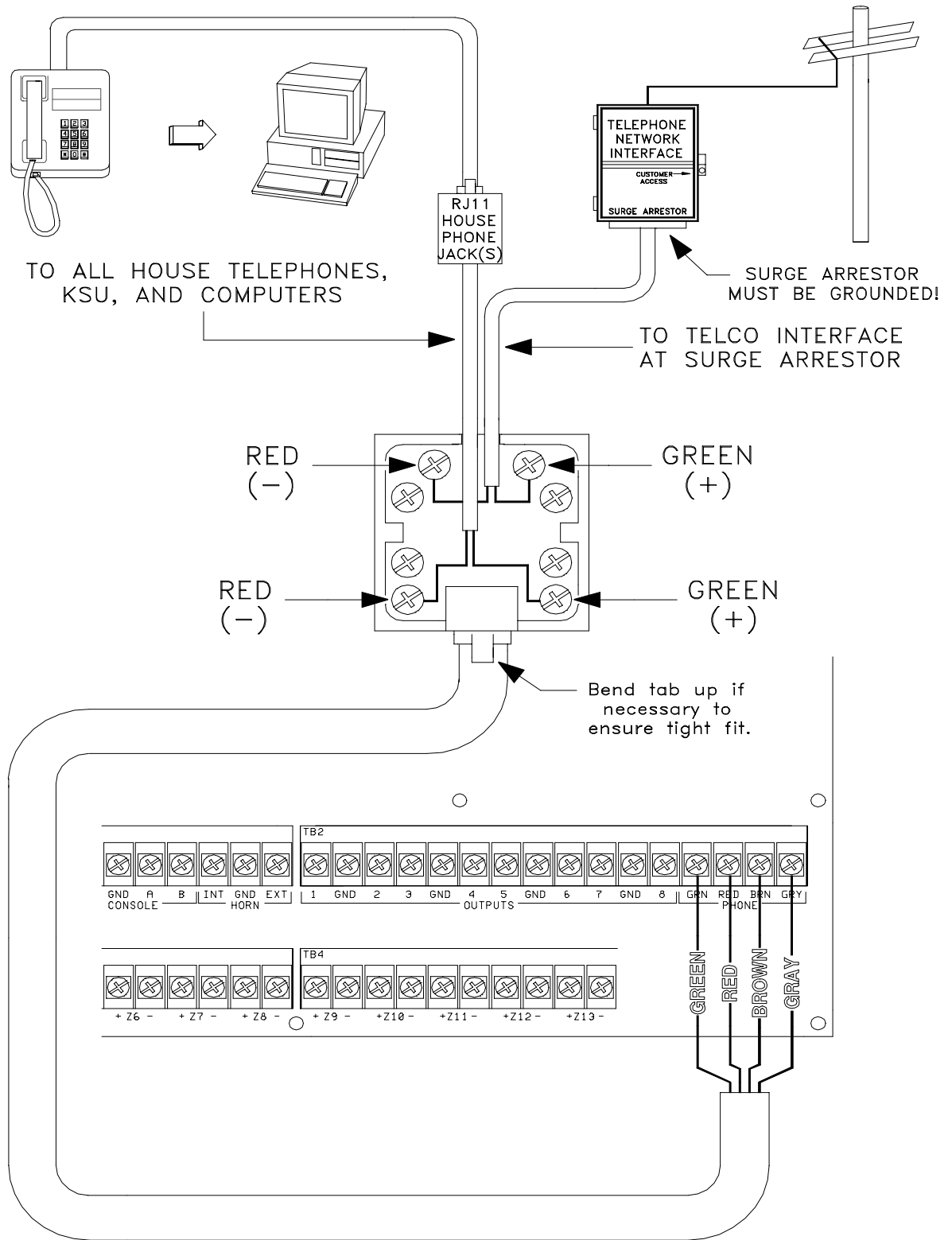

**FIGURE 4**  
**RJ31X JACK CONNECTIONS**

## LCD CONSOLE HOOKUP

1. 8 LCD Consoles MAXIMUM per system, subject to power availability.
2. Use 4 conductor 22 gage wire, 1000 feet maximum length. Consoles can be homerun or daisy chained. This length shall be divided by the total number of consoles at the end of the run. For example, for 8 consoles, the maximum length reduces to 125 feet. All LCD Consoles are connected to the same 4 wires, +12, GND, A, B.
3. The console should be mounted so that the LCD display is at or slightly above eye level. consoles should be kept out of the reach of young children. A good height is approximately 58 inches from the floor to the bottom of the console enclosure.
4. Remove console face from back plate (slots on bottom of console will release back plate, use a screwdriver). Mount the back plate to the wall. Mounting holes are designed to fit on a single or double gang box, or directly to the wall. Pull the wires from the wall through the opening in the back plate. Splice the wires to the supplied cable. Connect the cable to the connector on the console board (J1). Snap the console face on to the back plate.
5. Refer to **FIGURE 5 (CONSOLE CONNECTIONS)** for this configuration.

## CONSOLE SETUP

The console has different operating options that can be setup from the console to the user's preference. If more than one console is being used, it is required that you give each console a different address. You can change the address of a console through the console setup mode.

To enter the console setup mode, simultaneously press and hold the 4 and up arrow (↑) for approximately 1 second. The console will beep 5 times and enter the setup mode. The top line of the display will indicate what you are doing, followed by the current setting. The bottom line will show a menu of your options. To the lower right corner of the display is the direction arrow(s). Where possible, the up (↑), down (↓), and two-headed (×) arrow characters are shown on the console display to indicate which arrow keys may be pressed at that time. Press the down arrow (↓) key to advance to the next item. Press the up arrow (↑) key to go back to the previous item.

## CONSOLE ADDRESS

If you are installing more than one console, each console must be set to a different address. The default address setting is (1) - this is adequate if only one console is being used. The choices at the bottom are 1-16, however, the Omni only supports 8 consoles. When making your choice, choose an address between 1-8, then press the # (pound) key.

## SOUNDER

If you wish not to hear the beeper in the console for any reason, the sounder option can be turned off. Select (0) for OFF or (1) for ON, then press the # key.

## KEY CLICK

The sounder makes a click every time a key is pressed. This option may also be turned off. Select (0) for OFF or (1) for ON, then press the # key.

## KEY BACKLIGHT

The keys on the console keypad are lit. The keys can be never lit, always lit, or only lit when the LCD display is lit. Select (0) OFF, (1) for ON, or (2) TIMED, then press the # key.

## VIEWING ADJUSTMENT

This option is an adjustment for the viewing angle of the LCD display. This has been set to its best value at the factory, however, you may wish to tweak it. The display has 20 levels of adjustment. Select (1) for a lower viewing angle, or (2) for a higher viewing angle.

## LANGUAGE

This option is to display the 'console setup' text on the LCD display in English, French, Italian, or Spanish. Select one of the languages, then press the # key.

## EXIT SETUP MODE

To exit Setup Mode, press and hold the 4 and up arrow (↑) keys simultaneously for about 1 second. The console will return to normal operation. You may need to press (\*) to restore the display.

## CONSOLE SELF TEST

Use the self test mode to verify the proper operation of the console.

1. Disconnect the console from the controller. Connect +12 and GND terminals to a 12 volt source (or a fresh 9 volt transistor battery.) The console beeper will beep twice per second, the LCD backlight and the keypad key backlights will be lit, and the LCD will display "NO CONTROLLER DATA".
2. Simultaneously press and hold the 7 and the down arrow (↓) keys for approximately 3 seconds. The beeper will beep 5 times, the LCD backlight and keypad backlights will turn off, and the display will clear. The LED at the top right corner of the console will start to cycle through its different colors (red, green, yellow, then turns off). At the end of each cycle the beeper will beep once.
3. Press any key. The LCD backlight and the keypad key backlight will turn on.
4. Press the keys in the following order and verify that the appropriate character fills the screen. 0 - 9, \*, #, AWAY (A), NIGHT (B), DAY (C), OFF (D), ↑ (filled blocks), and ↓ (blanks).
5. If this is successful, the console is good. Simultaneously press and hold the 7 and down arrow (↓)keys to exit the self test mode or disconnect power.

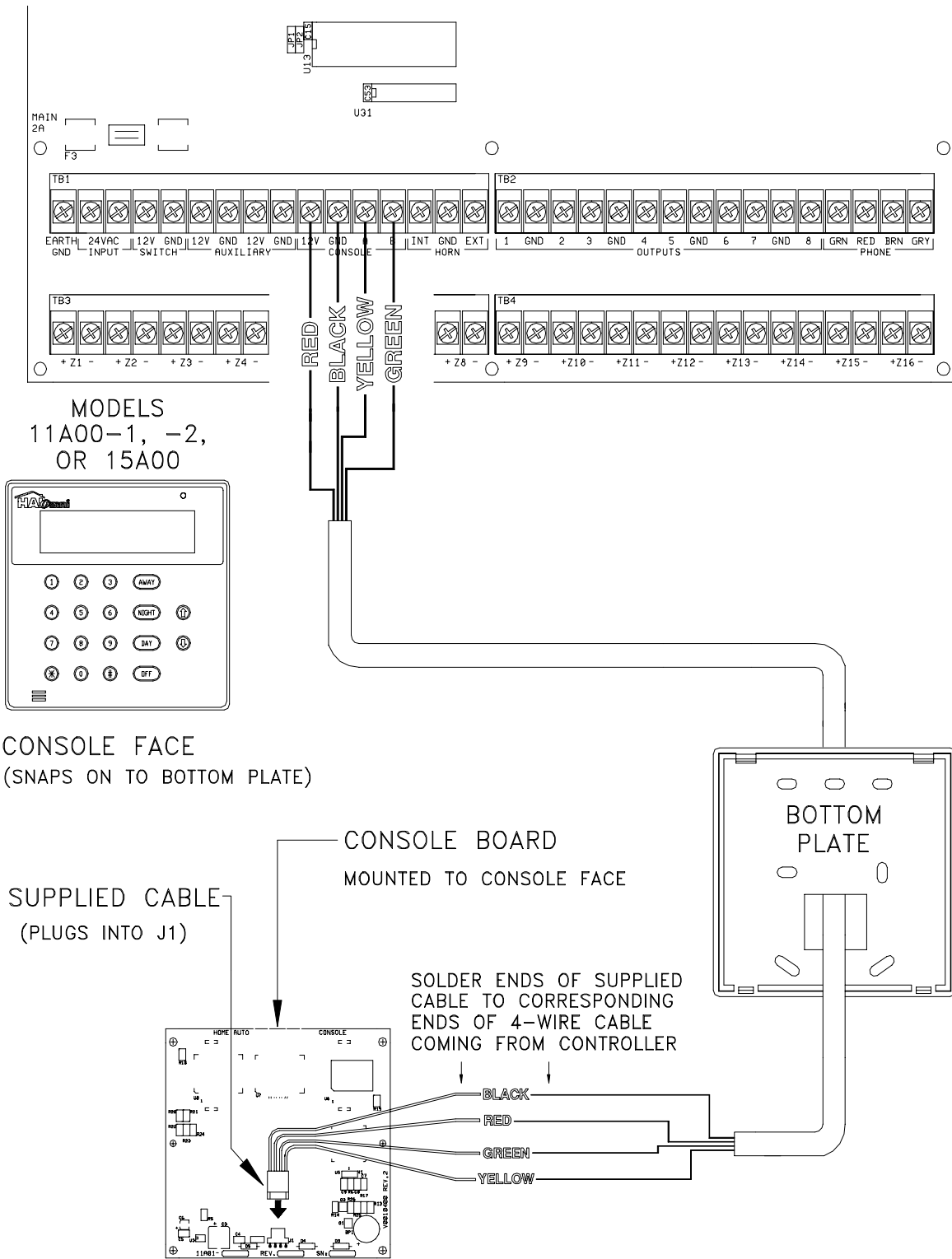

**FIGURE 5**  
**CONSOLE CONNECTIONS**





## EXTERIOR SOUNDER HOOKUP

1. If used, wire tamper switches to a tamper zone with a 1000 ohm end-of-line resistor.
2. Refer to **FIGURE 7 (EXTERIOR SOUNDER CONNECTION)** for connections.

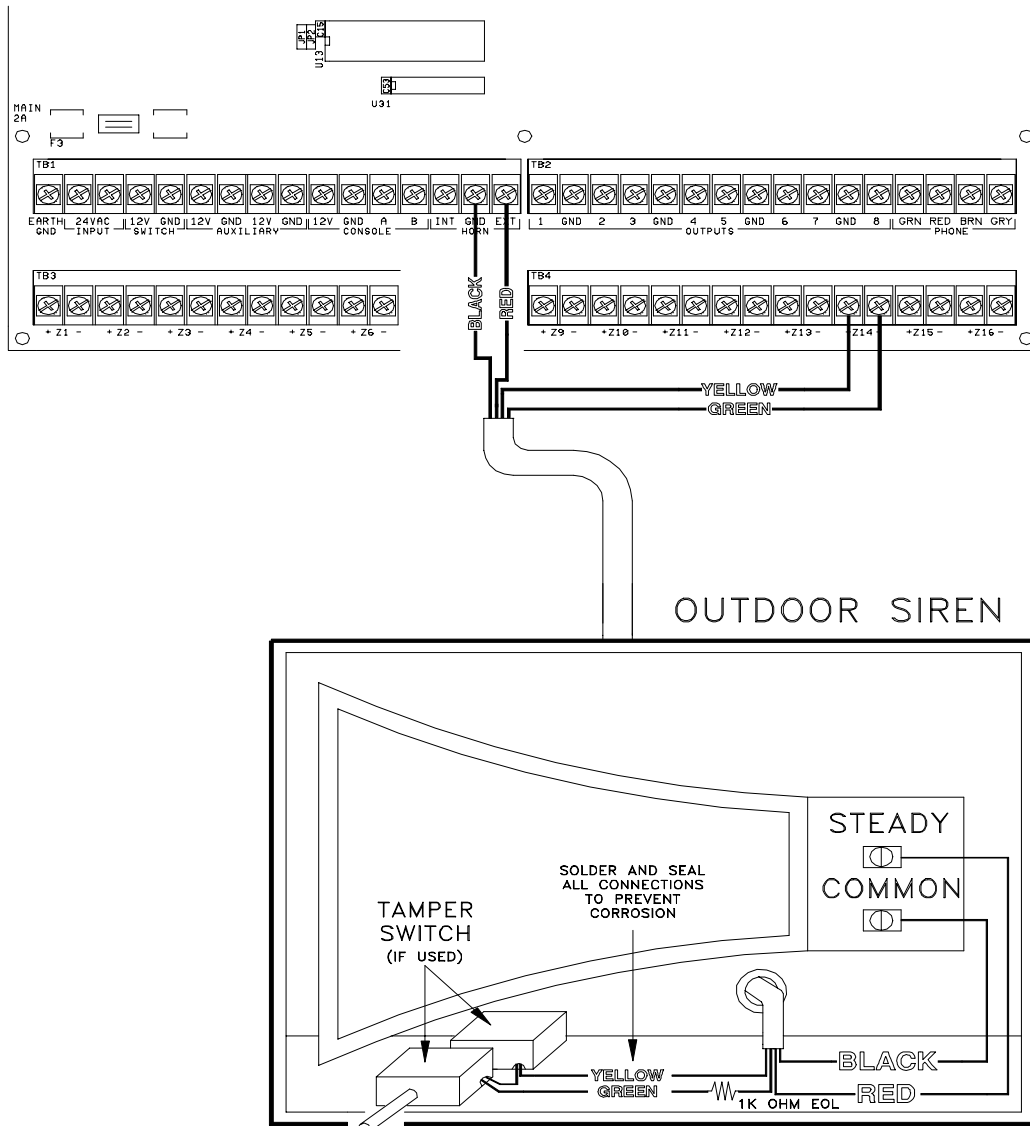

**FIGURE 7**  
**EXTERIOR SOUNDER CONNECTIONS**

## CONTROLLER OUTPUTS

The Omni provides 8 programmable hardwired voltage outputs and two horn voltage outputs. These outputs are programmable for the following output types:

- General Purpose low voltage switching applications (12 VDC) - Units 32 - 40
- Sounder triggering (a trigger for siren and voice drivers for BURG and FIRE)
- Communicator outputs (radio, cellular, or any other type of auxiliary communicator)
- 'ARMED' and 'OK TO ARM' outputs
- Programmable Energy Saver Modules
- HAI Communicating Thermostats (Output 8)

Outputs 1 - 8 can supply a **maximum** of 100 mA each. These outputs are included in the total DEVICES load, which cannot exceed 1 A. The HORN outputs can supply a **maximum** of 1 A each. HORN outputs are included in the total HORNS load, which can not exceed 1 A.

## GENERAL PURPOSE SWITCHING APPLICATIONS

This output will supply 12 VDC to the output terminal when its corresponding unit is ON. Output 1 is designated Unit 33, Output 8 is Unit 40. This can be used to drive relays for many different applications, including switching sprinkler valves and low-voltage lighting.

## SOUNDER TRIGGERING

This output can be used as a trigger for siren and voice drivers. When a driver requires a separate input for burglary and fire, you can configure this output to give a voltage trigger to the driver. Also, each area can have its own sounder.

## COMMUNICATOR OUTPUTS

This output can be used for radio communications or any other type of auxiliary communications to augment the built-in digital and voice dialers. Any communications device can be used with the Omni, provided that it is powered by 12 VDC, has 12 VDC triggered inputs, and has 2 (or more) channels.

The 'Communicator' outputs are activated 3 seconds before the Omni dialer begins to dial, either using its built-in digital dialer or voice dialer.

The following events will activate the BURG output: Burglar alarms (including panic zones), Auxiliary emergencies, Police emergencies, and Duress alarms. Fire alarms and the fire emergencies will activate the FIRE output.

## "ARMED" AND "OK TO ARM"

**ARMED:** When the system is armed in any of the security modes (AWAY, NIGHT, or DAY), this output will be active. It is typically used to activate a red LED to indicate that the system is 'armed'.

**OK TO ARM:** When all security zones are secure, no zones are bypassed, and the system is in the 'OFF' mode, this output will be active. It is typically used to activate a green LED to indicate that the system is 'ok to arm'.

## PROGRAMMABLE ENERGY SAVER MODULES

This output type is used to switch the relay in the Model 1101 PESM. Refer to the section on Programmable Energy Saver Modules for additional information.

## HAI COMMUNICATING THERMOSTATS

When HAI RC-Series thermostats are used, Output 8 is configured to communicate with up to 4 thermostats.

## REMOTE ARM/DISARM SWITCH

1. If desired, a remote keyswitch, keypad, or hidden arm/disarm toggle can be connected to the system. The device should have a momentary close type switch.
2. Configure one of the zone inputs as an ARM/DISARM TOGGLE zone. A closure of the switch contacts will toggle the arming mode between OFF and AWAY. (Entry and Exit delays are still active.)
3. Configure one of the outputs as an "ARMED" and another output as an "OK TO ARM" output. These outputs are used to activate a red or a green LED based on the state of the alarm system. The "ARMED" and "OK TO ARM" outputs can supply a **maximum** of 100 mA each. These outputs are included in the total DEVICES load, which cannot exceed 1 A.
4. Refer to **FIGURE 8 (REMOTE KEYSWITCH CONNECTION)** for this configuration.

NOTE: In UL Listed Installations, the Listed Ademco Model 9789 keyswitch shall be used.

## HOME CONTROL MODULES

Install X-10 or compatible modules EXACTLY as described in the instructions that come with each module. Watch the load ratings and types of load allowed. The Omni is designed to send signals to any device compatible with the X-10 power line carrier protocol.

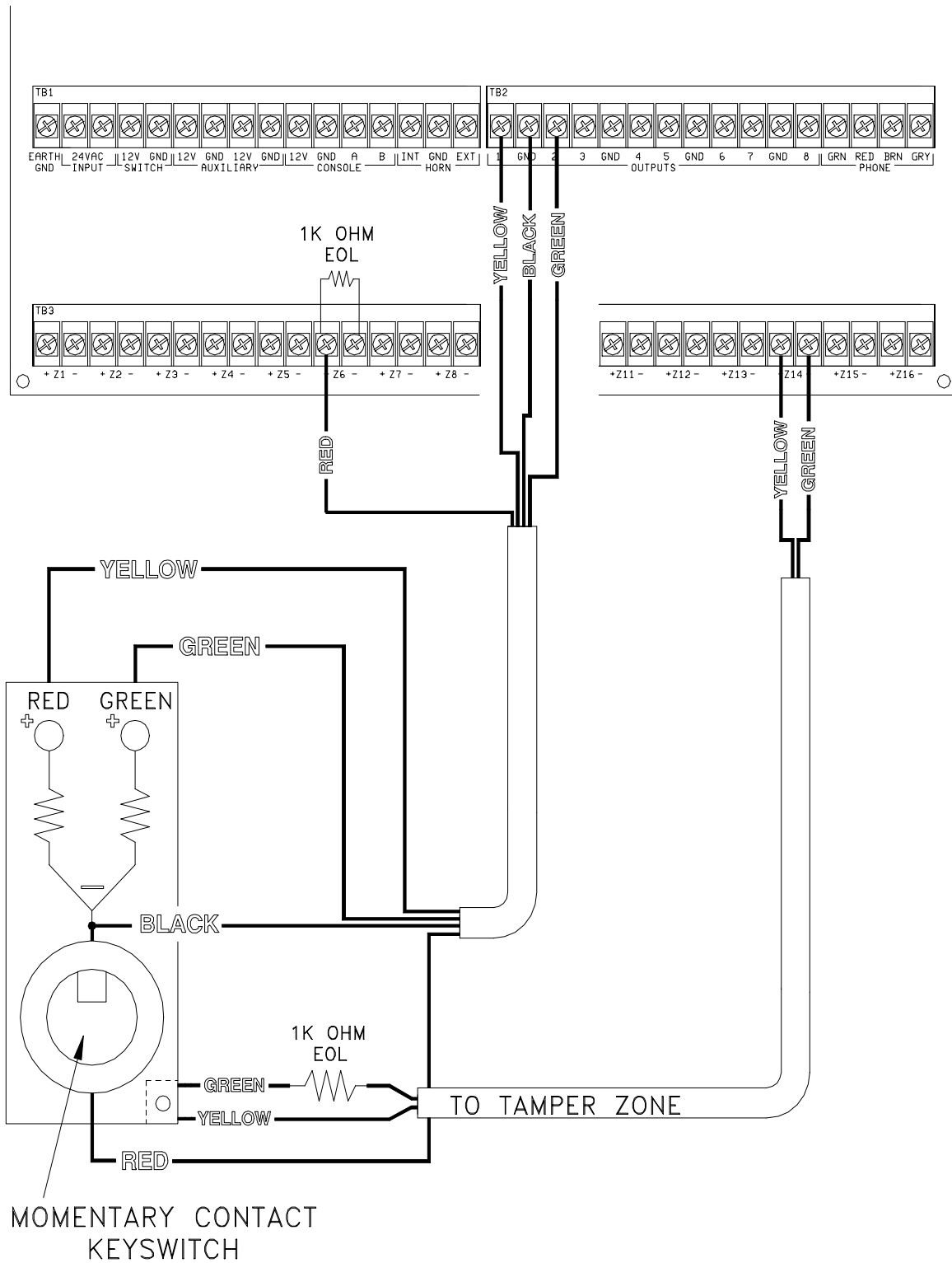

**FIGURE 8**  
**REMOTE KEYSWITCH CONNECTION**

## PROGRAMMABLE ENERGY SAVER MODULES

**NOTE: Programmable Energy Saver Modules must be connected to zones 9-16 on the Omni controller.**

1. The Omni can support up to 8 Model 1101 Programmable Energy Saver Modules. Each PESM requires one security zone input and one controller output. The zone input corresponds to the controller output (if zone 9 is being used, output 1 must be used as its pair). When setup as an Energy Saver Zone Type (Type 80), the zone and unit are used as a pair to read in temperature and control the setback temperature of the house. Only zones 9-16 may be configured as an Energy Saver zone.
2. Run a 4 conductor wire from the Omni controller to each Model 1101. Connect as shown in FIGURE 9. Be sure to install the 1101FK (included with PESM) as shown. The 1101FK reduces self-heating of the PESM relay.
3. The Model 1101 should be mounted on an interior wall, preferably close to the HVAC thermostat. Run a 2 conductor wire from the Model 1101 to the thermostat. Connect the Model 1101 between the RED wire going to the thermostat and the RED terminal on the thermostat. Mount the Model 1101 with the terminal strip on the bottom (mounting sideways or upside down may affect temperature reading).
4. Program the zone type for PESMs as a Type 80, Energy Saver.

### NOTES ON HVAC SYSTEMS

1. Description of the PESM

The Model 1101 PESM is a temperature sensor and control relay in a small enclosure that mounts near a central heating, ventilation, and air conditioning (HVAC) system thermostat. The PESM allows the automation system to read the temperature of the area that the HVAC system controls. The relay in the PESM is used to break the 24V RED wire between the thermostat and the HVAC system. When the automation system is in setback mode and the actual temperature is between the LO and HI setpoints, the relay energizes to break the 24V red wire; hence, the HVAC system will no longer operate.

In heating season, when the actual temperature falls below the LO setpoint, the automation system turns the relay in the PESM off, thus restoring power to the thermostat, which will call for heating. The PESM will cycle the thermostat on and off to maintain the LO setpoint.

In cooling season, when the actual temperature rises above the HI setpoint, the automation system turns the relay in the PESM off and the thermostat will call for cooling. The PESM will cycle the thermostat on and off to maintain the HI setpoint.

If the PESM is disconnected from the automation system, the relay will not energize and the HVAC system will operate normally, under the control of the thermostat.

2. Standard Heating and Cooling Systems

The PESM is compatible with all mechanical thermostats. Recommended thermostats are simple, round Honeywell T-87 thermostats. For automatic switch-over from heat to cool, consider a Honeywell T-874 (mechanical) or an Enerstat DSL-300 (electronic) thermostat, although any other mechanical thermostat from White Rodgers, Robertshaw, etc. will work.

The PESM is provided with an encapsulated 1K ohm resistor attached to a length of wire. In mechanical thermostats, the resistor allows enough current to keep the air conditioning mode "anticipator" in the thermostat warm. This decreases the response time for the air conditioner to come on when the Energy Saver is turned off. The resistor should be installed as shown in Figure 9.

The PESM is also compatible with electronic thermostats that run totally on battery power. Some examples of battery powered thermostats are Maple Chase Saverstat (Mfg. #0960-1), White-Rodgers Digital Programmable Thermostat (Mfg. #1F80-51), and Honeywell Chronotherm Thermostat. The 1K ohm resistor should not be used with battery powered thermostats.

### 3. Heat Pumps

Programmable Energy Saver Modules are compatible with heat pumps, however, the savings gained by setting the heat pump back may be erased by the auxiliary heaters when the heat pump tries to recover from the setback. A PESM will work best with heat pumps that have one or more of the following features:

- a. An outdoor temperature switch that prevents the auxiliary heat from coming on unless it is very cold outside. This is sometimes called a "heat balance" switch.
- b. A thermostat that uses rate of rise to determine if auxiliary heat is necessary: The Enerstat Model DSL-450. When recovering from setback, the thermostat runs the heat pump first. It will run the auxiliary heat only if the rate of temperature rise is less than 6 degrees F. per hour.
- c. An alternative auxiliary heat source that is inexpensive (i.e. gas).

These features will avoid the use of auxiliary heat (usually an electric strip heater) which is more expensive than using the heat pump when recovering from setback. In general, heat pumps take a longer time to recover from setback, so it may be advantageous to program a setback only for extended periods, such as a vacation.

## **OUTDOOR TEMPERATURE, TEMPERATURE SENSORS**

The Model 14A00 is a temperature sensor that mounts in an outdoor location, usually under an overhang, and sends the outdoor temperature to an Omni system. It is coated with a sealant to withstand outdoor moisture. The outdoor temperature can be displayed on the console, spoken over the telephone, or displayed on an HAI communicating thermostat.

1. Each Model 14A00 Temperature Sensor requires one zone input.
  - Program the zone type as an Outdoor Temperature (Type 81). It may also be programmed as a Temperature (Type 82), or Temperature Alarm (Type 83).
2. Plan to mount the Model 14A00 under an overhang or to the underside of an eave, otherwise known as the soffit, to protect it from direct sunlight and rain. Run a 4 conductor wire from the HAI controller to the selected location. Connect the red, black, and yellow wires exactly as described for the 1101 PESM using the 3 B-GEL water tight wire splices. The green conductor is not used.
3. Mount the 14A00 using the 2 - #6 x 1/2" stainless steel self-tapping screws.

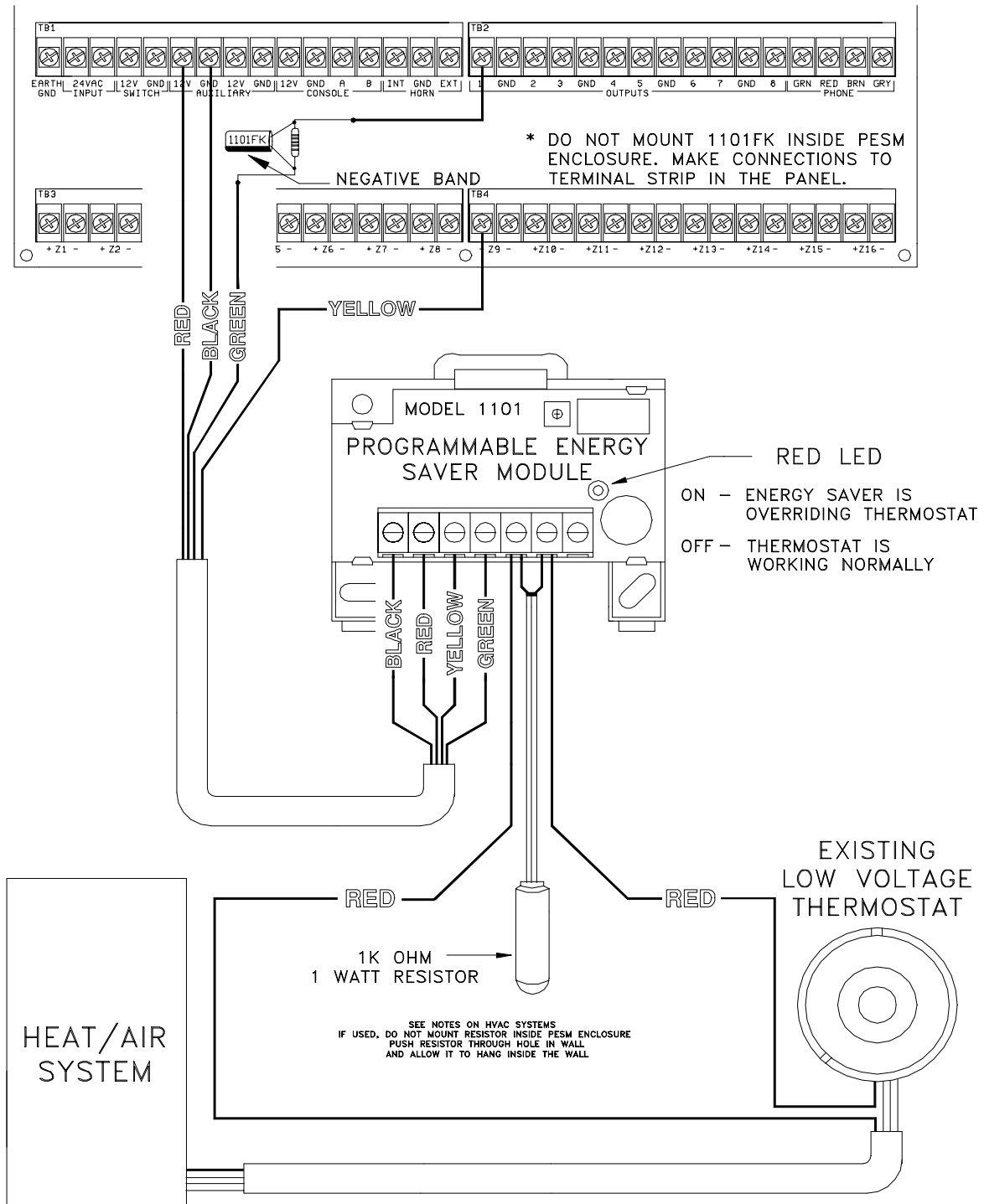

**FIGURE 9**  
**MODEL 1101 PESM CONNECTIONS**



## SYSTEM POWER UP PROCEDURE

1. Carefully review hookups to the zones, grounds, sounders, and consoles.
2. Disconnect 1 lead of both the interior and exterior sounders.

NOTE: Follow this power up procedure to verify proper operation of the power supply, battery charger, and low voltage cut out relay.

3. The positive lead to the battery should be disconnected at this time. Make sure that the red battery wire is not touching anything.
4. Plug in the power transformer.
  - The AC ON LED should illuminate. The Omni may make a faint hiss. This is normal.
  - The STATUS LED should begin blinking at a rate of 1 blink per second. This indicates that the Omni processor and software are working.
  - The PHONE LINE LED should be OFF (if all telephones are on hook (hung up) and the RJ31X jack is properly connected.
5. Unplug the power transformer to kill the system. Connect the red battery wire to the + (positive) battery terminal. The system should not start.
6. Plug in the power transformer. The system should start.
7. Unplug the power transformer. The system should continue to run on the battery (as evidenced by the flashing STATUS LED)
8. Plug the transformer back in and secure it to the outlet.

## CONSOLE CHECK OUT

1. The console(s) should be operating. Press ' \* ' to silence the trouble beeper if it is beeping. Press OFF, 1, 1, 1, 1 (or the current User code) if the alarm is tripped. If the consoles are not operating properly, make sure that no two consoles have the same address, and check the wiring.
2. With all doors and windows closed, all motion detectors normal, the bottom line of the display should read SYSTEM OK. If there are any trouble indications that occurred during installation, press ' \* ' to acknowledge them and silence the beeper.
3. Set the time and date by pressing the 8, enter the Master Code, then 2 key. Enter the time on the keypad, then the DATE (enter date as 6 characters; January 1, 95 as 010195).
4. The console should now show the time and date on the top line, "SYSTEM OK" on the bottom line.

## **TELEPHONE CHECK OUT**

1. Verify that the Telephone company surge arrestor is properly grounded.
2. Verify that the incoming telephone lines are run to the surge arrestor first, then from the surge arrestor to the RJ31X jack, then from the RJ31X jack to the house phones.
3. The PHONE LINE LED, on the controller, should be off when the phones are hung up.
4. Pick up an in-house phone, wait about 1 second, then press the '#' key. You should hear the Voice menu on the phone. If not, check to see that the RJ31X jack is properly wired and connected to the controller. There should be no interference from the telephone company while the menu is being read over the phone.
5. Record the owner's NAME and ADDRESS in the ADDRESS speech memory as shown in SETUP ADDRESS in the OWNER'S MANUAL (Press 8, 9, then 1111 or the current Master code to record the address).

NOTE: DO NOT record any TOUCH TONES in the ADDRESS!!

6. Check that all in-house phones are working.

## **BURGLAR ZONE CHECK OUT**

1. With all doors and windows closed, all motion detectors and security devices normal, you should have "SYSTEM OK" on the console.
2. If any zones are abnormal, check your wiring. If the battery indication is low, make sure that the battery is connected securely. Give the battery a chance to charge.
3. From the top-level display, have a partner go around the house and trip each sensor one at a time. The display should indicate the correct zone "NOT RDY" when the zone is tripped, then return to "SYSTEM OK" when the zone is secured. Be sure that the zone type indicated (ENTRY/EXIT, PERIMETER, ETC.) is correct for the zone being tested.
4. If the zone being checked is armed, (i.e. PANIC or TAMPER type, which is always armed) the alarm will be activated. Press OFF and 1111 or the current User code to silence the alarm, or bypass the PANIC and TAMPER zone(s) before you start.
5. Reconnect the sirens. Be sure that no one is standing near a siren. Activate the alarm, and ensure that both the inside and, after a delay, outside sirens activate.

## **FIRE ZONE CHECK OUT**

1. Press '\*' to return the console to the SYSTEM OK indication. Check the fire zone per the sensor manufacturer's instructions. The fire alarm should be activated (pulsing interior sounder, exterior siren).
2. Press '\*' to silence the alarm. The display will still indicate that the FIRE ZONE is in alarm.
3. Press DAY or NIGHT or AWAY and the User code to arm the system, then OFF and the User code to disarm. This arm/disarm cycle will reset the smoke detector. If the cause for alarm (i.e. smoke) has cleared, the display will return to SYSTEM OK.

NOTE: Be sure that the DIAL OUT DELAY is long enough so that you can cancel the alarm before the system dials out.

## **HOME CONTROL CHECKOUT**

1. Confirm that the HOUSE CODE on the Omni is set to the same HOUSE CODE set on all of the modules (See SETUP CONTROL).
2. On the console press 4, 1 (ALL ON). All lamp type modules should go on. Note that appliance modules and auxiliary outputs do not respond to ALL ON.
3. On the console press 4, 2 (ALL OFF). All modules should go off. Note that auxiliary outputs do not respond to ALL OFF.
4. Operate each unit number individually and verify that it works. Write down its unit number and description on the PLANNING/CHECKLIST sheets.
5. Ensure that auxiliary inputs and outputs are working.

## **CUSTOMER CHECKOUT**

After you have completed the system check out and everything works, be sure that the customer knows how to:

1. Disarm/silence the system (OFF, 1111 or current User code). **HAVE THE CUSTOMER PRACTICE!**
2. Change the codes.
3. Get the menu over the in-house phones.

### **You should also:**

4. Demonstrate arming and disarming.
5. Demonstrate home control.
6. Demonstrate setup and programming.
7. Show him/her how to program the dial out numbers.
8. Deliver the Owner's Manual and copies of the Planning/Checkout sheets.
9. If the customer has subscribed to a central monitoring service, this should be explained to him/her.

## **IN CASE OF TROUBLE**

### **CONSOLES**

If you experience trouble that seems to be with a console, try disconnecting the console and running the console self test as described under CONSOLE HOOKUPS in this manual. If the console does not run the self test properly, it should be returned to HAI for repair.

"NO CONTROLLER DATA" or erratic operation of the LCD display could be a result of: A and B terminals connected backwards, poorly, or 2 or more consoles have the same address.

### **CONTROLLER**

Check the AC ON (bottom) LED. If it is not lit, check for 24 VAC at the transformer connections and the fuse on the controller board marked MAIN 2 A.

Check the STATUS (top) LED on the controller board. It should be blinking once per second, indicating the proper operation of the microprocessor and memory. If not, try powering the system down: Disconnect the power transformer and battery, then reconnect both. The status light should begin blinking.

If the AC ON LED is on and the STATUS light is still not blinking, check the AUX +12 V with a DC voltmeter. It should be 13.7 volts. If not, make sure that there isn't too much load on the system. Disconnect all loads. If the STATUS LED still won't blink, there is a problem with the controller board and it must be returned to HAI for repair.

Phone line problems, or problems with the Omni voice are usually the result of the RJ31X jack being improperly wired. Check RJ31X jack wiring and polarity carefully, as described in TELEPHONE CONNECTIONS.

In the event that the controller is found defective, the controller board can be removed without disconnecting all of the house wiring from their terminals. The terminal strips can be removed from the controller board. Then the controller (or processor board) can be repaired and reinstalled easily.

**Follow this procedure for removing the controller board:**

1. If possible, upload the programs and configuration. (This will not be possible if the status LED isn't flashing, or if you can't get the voice to work.)
2. Unplug the power transformer.
3. Disconnect the battery
4. Disconnect the RJ31X modular cable at the jack!! (If you only disconnect it at the Omni controller, the house phones won't work.)
5. Disconnect the X-10 cable.
6. Carefully remove the four terminal strips from the controller board. Gently push down on terminal strip retention clips. These clips are located on either end of the strip and 2 in the middle. Slowly pull strip away from terminal block socket and secure.
7. Remove 9 screws and washers; 3 on the top edge, 3 on the bottom edge, and 3 in the middle of the controller.
8. Remove the controller board.
9. Protect the back of the controller board with cardboard, pack carefully. HAI will not be responsible for returned items damaged due to inadequate packaging.
10. Call Home Automation, Inc. with the serial number for a return authorization number to help us track your return. Write the R. A. # on the outside of the package.
11. Return the controller to Home Automation, Inc. Please include your return address, any special shipping instructions, and a daytime phone number so that we can reach you if we have any questions. Also include a brief description of the problem that you are having.
12. INSTALLATION: follow the removal process in reverse. Follow the POWER UP and CHECK OUT procedures in this manual.

**FOR HELP:** Call Home Automation, Inc., between the hours of 9:00 AM and 5:30 PM Central time, at (800) 229-7256.

## **X-10 TROUBLESHOOTING TIPS**

1. If any light does not work, check the HOUSE CODE on the module. It must be set to the same house code as the Omni.
2. Operate the module locally to ensure that power is getting to it. You should be able to turn the light or appliance on using its switch (turn it on, then off, then on again for plug in modules, press the on/off switch for wall switch modules.)
3. Three-way wall mounted lamp switches must be installed using the exact procedure described in their instruction sheet. The key to success with three-way wall switches is to identify the wire that was connected to the COMMON terminal of the old manual switches and to following the instructions precisely.
4. Modules that work intermittently from the Omni but reliably locally usually have a problem "hearing" the X-10 signal over the power lines. Some tips:
  - Make sure connections to the modules and to the TW523 interface are tight. Loose fuses, wirenuts, circuit breakers, terminal blocks, corrosion, etc. can sometimes inhibit the X-10 signal.
  - Run a separate wire from the Omni controller directly to the fuse or breaker panel to ensure that the X-10 signal has a clear path to the panel where it can be distributed to the other circuits. Try changing the phase that the system is on.
  - Install a .1 MFD 600 volt non-polarized capacitor between the phase that the powerline interface is on and the other phase(s). BE VERY CAREFUL DURING INSTALLATION. Be sure that the capacitor is on the protected side of the fuses or breakers. This will bridge the signal to the other phases.
  - Items such as electric heaters (resistive loads) and power filters (capacitive loads) tend to absorb the X-10 signal. Try relocating them, if possible.
  - Interference from neighboring systems can be solved by changing the house code to a different one from the neighboring system.
  - Identify any devices that could be transmitting a continuous signal on the powerlines. Wireless Intercoms locked in the transmit mode will prevent X-10 signals from getting out. These are not compatible with X-10.

## **DIGITAL COMMUNICATOR**

The Omni digital communicator uses standard 4/2, (20 pps, 1800 Hz data, 2300 Hz handshake), or (10 pps, 1900 Hz data, 1400 Hz handshake), dual round compared format. Although the alarm codes can be changed, we recommend that the alarm codes setup at the factory be used to minimize the risk of installer error in programming the digital communicator. Simply enter the phone numbers and account codes, then verify the alarm codes.

4/2 format can be received by any central station with modern equipment. Compatible receivers are Ademco, Radionics, Osborne-Hoffman, Linear, FBI, Silent Knight and most others.

### **DESCRIPTION OF 4/2 FORMAT**

The 4/2 format consists of a four digit account code, from 0000 to FFFF and a two digit alarm code from 00 to FF. When the digital communicator calls the central station receiver, the latter answers and sends a brief 2300 Hz tone or a 1400 Hz tone called a "Handshake" tone. The digital communicator then reports digits of the account and alarm codes as bursts of either (1800 Hz) or (1900 Hz) tone; the digit 8 is represented by eight bursts of tone. A message, or "round" consists of an account code and an alarm code. Two rounds are sent, and two consecutive rounds must match at the receiver. If they do, the central station receiver sends another brief 2300 Hz or 1400 Hz tone to acknowledge to the digital dialer that the message has been properly received. If the rounds don't match, the receiver does not send the second tone and the digital dialer tries again, up to 5 times. If the rounds are not acknowledged after 5 tries, the digital dialer hangs up and tries the entire call again.

If the digital dialer does not get a handshake signal 45 seconds after it begins dialing, it hangs up and tries again. The dialer will try the **FIRST PHONE NUMBER** 5 times, then go to the **SECOND PHONE NUMBER** and try that 5 times. After that, the system will indicate **COMMUNICATIONS FAILURE** on the console display and the digital communicator will not try again until another reportable event occurs.

The **FIRST ACCT NUMBER** will be used when the central station is called using the **FIRST PHONE NUMBER**. The **SECOND PHONE NUMBER**, if specified, will be called if the communicator is unable to successfully communicate using the **FIRST PHONE NUMBER/FIRST ACCT NUMBER**. The **SECOND ACCT NUMBER** will be used when the central station is called using the **SECOND PHONE NUMBER**.

The digital communicator can report alarm zone trips, alarm cancels, low battery, and fire zone trouble. It may also be setup to generate an automatic test signal at periodic intervals. The communicator may be setup to call a second phone number using a second account number in the event that it is unable to communicate successfully using the first phone number and account.

The digital communicator is setup at the factory to transmit a code when the battery is low or trouble with the fire zone is detected. If these codes are set to 0 or 00, no code will be sent when the trouble condition is detected.

The digital communicator will not dial out until the **DIAL OUT DELAY** has expired. If the alarm is canceled prior to the expiration of the **DIAL OUT DELAY**, no transmission will take place. After the **DIAL OUT DELAY** has expired, though, all alarm trips will be transmitted followed by a **CANCEL** code.

When the digital communicator is used, all voice dial outs will be delayed for five minutes after the expiration of the dial out delay to allow time for the central station to call the premises after an alarm code has been sent.

If the digital communicator is unable to successfully communicate with the central station, the user will be alerted to the COMMUNICATOR trouble condition. When the system status is requested using the voice, this condition is reported over the phone as "SECURITY PHONE MESSAGE" trouble.

### **3/1 FORMAT**

Older central stations may require a 3/1 format. To use 3/1 format, both account numbers must be changed to 3 digit codes and EVERY alarm code must be changed to a 1 digit code. Do not mix code lengths!

### **OPENING AND CLOSING REPORTS**

The Omni system can send opening and closing reports by user to the central station.

When the system is disarmed by user code 1-16, the communicator can call the central station and report that the system was disarmed (opened) with the user code that was used.

When the system is armed by user code 1-16, the communicator can call the central station and report that the system was armed (closed) with the user code that was used.

If the system is disarmed by any other method other than one that requires a user code (i.e. Keyswitch or Scheduled Program), the communicator will send a generic OPEN report to the central station. The code that is sent is defined as OTHER OPEN.

If the system is armed by any other method other than one that requires a user code (i.e. Quick Arm, Keyswitch, or Scheduled Program), the communicator will send a generic CLOSE report to the central station. The code that is sent is defined as OTHER CLOSE.



## INSTALLER SETUP

This section describes the items that the installer must setup as part of system installation. The Installer Setup mode is used to configure the general operation of the system, the Outputs, the Areas, the Zone Types, and the Digital Communicator. This information is covered only in this manual. All other SETUP items, including delay times, zone and unit names, voice dialer, and codes are covered in the Owner's Manual, Document No. 10R00.

SETUP items are stored permanently in the system, even if the battery and AC power are disconnected. The "default" settings are the ones that have been set at the factory. You can review or change the setup items easily, as shown below. If changes have been made from the default settings, it is suggested that they be written in the space provided at the end of this section. **Note:** The default Installer Code is 1111.

To enter the Installer SETUP menu, press 8, and the installer code to get the Setup Menu, then press the # (INST) key.

```
INSTALLER SETUP MENU:  
1=CTRL  2=ZONE  3=DCM  ↓  
  
4=AREA  5=TEMP  6=MISC  ↑
```

## SETUP CONTROL

To setup the X-10 and Auxiliary Outputs, from the Installer Setup menu, select the 1 (CTRL) key. The base X-10 house code must be specified, as well as the output type for each of the Auxiliary Outputs. The output type for both the interior and exterior horns may also be changed.

Press (↓) to advance to the next item, (↑) to go back.

The base house code is the house code for units 1-16 and is referenced as house code 1. The house code for the units 17-32 is the next house code after the base house code, or house code "B" if the base house code is "A". This house code is referenced as house code 2.

An output type must be specified for each of the auxiliary outputs and for the interior and exterior horn outputs. The following output types are available:

TYPE	NUMBER	DESCRIPTION
GENERAL PURPOSE	0	General Purpose Output
OK TO ARM	1	OK To Arm
ARMED	2	Armed
PRE-ALM SNDR	3	Pre-Alarm Sounder
INT SNDR	4	Interior Sounder
INT BURG SNDR	5	Interior Burglary Sounder
INT FIRE SNDR	6	Interior Fire Sounder
EXT SNDR	7	Exterior Sounder
EXT BURG SNDR	8	Exterior Burglary Sounder
EXT FIRE SNDR	9	Exterior Fire Sounder
BURG COMM	10	Burglary Communicator

TYPE	NUMBER	DESCRIPTION
FIRE COMM	11	Fire Communicator
AUX COMM	12	Auxiliary Communicator
A1 OK TO ARM	17	Area 1 OK To Arm
A1 ARMED	18	Area 1 Armed
A1 PRE-ALM SNDR	19	Area 1 Pre-Alarm Sounder
A1 INT SNDR	20	Area 1 Interior Sounder
A1 INT BURG SNDR	21	Area 1 Interior Burglary Sounder
A1 INT FIRE SNDR	22	Area 1 Interior Fire Sounder
A1 EXT SNDR	23	Area 1 Exterior Sounder
A1 EXT BURG SNDR	24	Area 1 Exterior Burglary Sounder
A1 EXT FIRE SNDR	25	Area 1 Exterior Fire Sounder
A1 BURG COMM	26	Area 1 Burglary Communicator
A1 FIRE COMM	27	Area 1 Fire Communicator
A1 AUX COMM	28	Area 1 Auxiliary Communicator
A2 OK TO ARM	33	Area 2 OK To Arm
A2 ARMED	34	Area 2 Armed
A2 PRE-ALM SNDR	35	Area 2 Pre-Alarm Sounder
A2 INT SNDR	36	Area 2 Interior Sounder
A2 INT BURG SNDR	37	Area 2 Interior Burglary Sounder
A2 INT FIRE SNDR	38	Area 2 Interior Fire Sounder
A2 EXT SNDR	39	Area 2 Exterior Sounder
A2 EXT BURG SNDR	40	Area 2 Exterior Burglary Sounder
A2 EXT FIRE SNDR	41	Area 2 Exterior Fire Sounder
A2 BURG COMM	42	Area 2 Burglary Communicator
A2 FIRE COMM	43	Area 2 Fire Communicator
A2 AUX COMM	44	Area 2 Auxiliary Communicator

The first group of outputs is global. The sounder and communicator outputs will be activated for an alarm in any area. The remaining types are area specific. Area specific sounder and communicator types will only be activated for alarms in that area. The Setup Control items are:

```

X-10 HOUSE CODE:      A
1-16=A-P              ↓

OUTPUT 1 TYPE:        0
GENERAL PURPOSE #=CHNG ×

OUTPUT 2 TYPE:        0
GENERAL PURPOSE #=CHNG ×

OUTPUT 3 TYPE:        0
GENERAL PURPOSE #=CHNG ×

OUTPUT 4 TYPE:        0
GENERAL PURPOSE #=CHNG ×

```

OUTPUT 5 TYPE: 0  
GENERAL PURPOSE #=CHNG ×

```

OUTPUT 6 TYPE:          0
GENERAL PURPOSE #=CHNG ×

OUTPUT 7 TYPE:          0
GENERAL PURPOSE #=CHNG ×

OUTPUT 8 TYPE:          0
GENERAL PURPOSE #=CHNG ×

INTERIOR HORN:          4
INT SNDR                #=CHNG ×

EXTERIOR HORN:          7
EXT SNDR                #=CHNG ↑

```

For output types, the current setting is shown on the bottom line. Press the '#' key to select a new type from a list of types. The display shows:

```

SELECT TYPE:            6
INT SNDR                ×

```

Use the Up and Down arrow keys to scroll through the list, or select the appropriate output type number. Then press '#' to enter the new type.

## SETUP ZONES

To setup the zone type for each security zone, from the Installer Setup menu, select the 2 (ZONE) key.

### ZONE EXPANSION

If an expander is being used, you must also specify whether a hardwired zone expander or wireless receiver is being used.

```

ZONE EXPANSION:        0
0=NONE  1=H/W  2=RCVR ↓

```

### Z 1 TYPE THROUGH Z 32 TYPE

This item specifies the zone type for each zone. The possible choices are listed in this manual under DESCRIPTION OF ZONE TYPES.

For zone types, the current setting is shown on the bottom line.

```

ZONE 1 TYPE:           64
AUXILIARY              #=CHNG ×

```

### THROUGH

```

ZONE 32 TYPE:          64
AUXILIARY              #=CHNG ↑

```

To change a zone type, use the arrow keys to scroll through the list of zone types then press ' #' to select a new type. The display shows:

```

SELECT TYPE:          64
PERIMETER             x
  
```

### **ZONE RESPONSE TIME**

All zones, in the Omni are set to 300 milliseconds fixed response time.

### **ZONE TYPES**

<b>TYPE</b>	<b>NUMBER</b>	<b>DESCRIPTION</b>
ENTRY/EXIT	0	Entry/Exit
PERIMETER	1	Perimeter
NIGHT INT	2	Night Interior
AWAY INT	3	Away Interior
2X ENTRY DELAY	4	Double Entry Delay
4X ENTRY DELAY	5	Quadruple Entry Delay
LATCH PERIM	6	Latching Perimeter
LATCH NIGHT INT	7	Latching Night Interior
LATCH AWAY INT	8	Latching Away Interior
PANIC	16	Panic
POLICE EMERG	17	Police Emergency
SILENT DURESS	18	Duress
TAMPER	19	Tamper
LATCH TAMPER	20	Latching Tamper
FIRE	32	Fire
FIRE EMERG	33	Fire Emergency
GAS	34	Gas Alarm
AUX EMERG	48	Auxiliary Emergency
TROUBLE	49	Trouble
FREEZE	54	Freeze
WATER	55	Water
FIRE TAMPER	56	Fire Tamper
AUXILIARY	64	Auxiliary
KEY SWITCH	65	Keypress Input
ENERGY SAVER	80	Programmable Energy Saver Module
OUTDOOR TMP	81	Outdoor Temperature
TEMPERATURE	82	Temperature
TEMP ALARM	83	Temperature Alarm

### **LATCHING ZONE TYPES**

LATCHING ZONE TYPES ignore the status of that zone during power cycles. Used primarily when more than one area is being protected, this type will ignore the status of LATCHING ZONES in that area when the power is switched to devices due to an arming in another area.

If the FIRE ALARM VERIFICATION feature is being used, any device (other than FIRE or GAS) connected

to SWITCH 12V (i.e. Glassbreak Detectors) must be connected to a zone configured as a LATCHING ZONE TYPE (latching perimeter, latching night interior, latching away interior, and latching tamper).

## **DESCRIPTION OF ZONE TYPES**

### **ENTRY/EXIT**

ENTRY/EXIT ZONE types are intended for doors. ENTRY/EXIT ZONES are armed in security modes DAY, NIGHT, AWAY, and VACATION. In DAY and AWAY modes, there is an entry delay (defined by ENTRY DELAY) on ENTRY/EXIT ZONES to allow you to get into the house and turn off the alarm before it sounds. In NIGHT & DAY INSTANT mode, there is no entry delay, so that the alarm sounds immediately if someone opens a door.

There are two special types of ENTRY/EXIT ZONES for use with garage doors, or doors that are far away from the control console. They are called Double Entry Delay and Quadruple Entry Delay zones. These zones have double or quadruple the ENTRY DELAY to give you additional time to reach the console to disarm the system upon returning. Only the ENTRY DELAY is extended on these zone types. The EXIT DELAY is not extended.

If an ENTRY/EXIT ZONE is tripped first, all other zones will also be delayed.

### **PERIMETER and LATCHING PERIMETER**

PERIMETER ZONE types are intended for windows and exterior doors not requiring an entry delay. All PERIMETER ZONES are armed in security modes DAY, NIGHT, AWAY, and VACATION. There is not an entry delay on a perimeter zones. If a window or door on this zone is opened while the security system is in DAY, NIGHT, AWAY or VACATION mode, the alarm will sound immediately.

LATCHING PERIMETER ZONES ignore the status of that zone during power cycles.

### **NIGHT INTERIOR and LATCHING NIGHT INTERIOR**

NIGHT INTERIOR ZONES are intended for motion detectors in areas where no one should be while you are sleeping in your home. For example, if you have a two story home and sleep upstairs, your downstairs motion detector(s) should be on a NIGHT INTERIOR ZONE.

NIGHT INTERIOR ZONES are armed in security modes NIGHT, VACATION, and AWAY only. There is no delay on a NIGHT INTERIOR ZONE. Night interior zones are NOT armed in DAY or DAY INSTANT mode, so that you may move about freely in your home when the security system is in DAY or DAY INSTANT mode, while still having the windows and doors protected.

LATCHING NIGHT INTERIOR ZONES ignore the status of that zone during power cycles.

### **AWAY INTERIOR and LATCHING AWAY INTERIOR**

AWAY INTERIOR ZONES are for all other areas of your home, where no one should be while you are away. In the previous example, your upstairs motion detector(s) should be on an AWAY INTERIOR ZONE. AWAY INTERIOR ZONES are armed only when the security mode is AWAY.

LATCHING AWAY INTERIOR ZONES ignore the status of that zone during power cycles.

## **PANIC, TAMPER, and LATCHING TAMPER**

PANIC and TAMPER ZONES are for emergency pushbuttons and tamper switches. PANIC and TAMPER ZONES are ALWAYS ARMED, even if the security mode is OFF. There are no delays on PANIC and TAMPER ZONES, however, the Omni waits the DIAL OUT DELAY before dialing out.

TAMPER ZONES should be used for items such as gun cabinets and liquor closets.

LATCHING TAMPER ZONES ignore the status of that zone during power cycles.

## **POLICE EMERGENCY**

This zone type activates the burglar alarm and makes an emergency dial out. The interior and exterior sounders are activated immediately. There is a delay before dialing out.

## **DURESS EMERGENCY (SILENT DIAL OUT)**

If you wish to have a button in your home that activates a SILENT dial out, that is, one with no lights flashing, no interior sounder and no exterior sounder, that button should be connected to a zone, and the zone type for that zone should be changed to DURESS EMERGENCY. Use caution in assigning a zone type to DURESS EMERGENCY. If this zone is accidentally tripped, you will not know that the Omni is making a silent dial out, and hence won't know to stop it if it was a mistake.

To stop a silent dial out once it has started, you must go to the console and press OFF then enter your user code number.

## **SUPERVISED FIRE**

Any zone in the Omni can be programmed as a SUPERVISED FIRE ZONE. In UL Listed Installations, any fire zone must be supervised and connected as shown in this manual.

## **FIRE EMERGENCY**

This zone type activates the fire alarm for a NORMALLY CLOSED, OPEN FOR ALARM loop. It is not supervised as required for UL Listed Installations and shall NOT be used in such installations.

## **GAS**

This GAS ALARM will generate an alarm, activate interior and exterior sounders (on - off - on - long off), and make a dial out.

## **AUXILIARY EMERGENCY**

This AUXILIARY EMERGENCY ALARM ZONE type will generate an alarm (console beeper, no sirens) and make an emergency dial out when the zone is violated.

## **TROUBLE**

This zone type can be used to monitor the status of an external device, such as the battery status of a wireless security receiver. When the zone is open, the zone name will be displayed on the display as "NOT RDY".

The alarm is not activated, regardless of the security mode. The trip is logged in the event log. The digital communicator (if used) will report the alarm code for the zone. The voice dialer will not be activated. This zone type can be used to record events in the event log - driveway activation, opening of a gate, outdoor motion, etc. without setting off the alarm. If the digital communicator is programmed for other alarms, this zone can be excluded by programming the alarm code for this zone to 0.

### **FREEZE**

This FREEZE ALARM ZONE type will generate an alarm (console beeper, no sirens) and make an emergency dial out when the zone is violated.

### **WATER**

This WATER ALARM ZONE type will generate an alarm (console beeper, no sirens) and make an emergency dial out when the zone is violated.

### **FIRE TAMPER**

This zone type is used to monitor the wiring to bells and sirens. The zone will report trouble if an open, short, or other wiring problem is detected in the supervised bell circuit. This zone will make a digital dial out when violated. In UL Listed Installations, each fire siren must be supervised by a fire tamper zone connected as shown in this manual. **Note:** Only Zones 1-8 can be configured as FIRE TAMPER zones.

### **AUXILIARY INPUT**

A zone defined as an AUXILIARY INPUT is ignored by the security part of the system. It is used to activate "button" commands or to conditionalize programs.

### **KEYSWITCH INPUT**

This zone is used to arm in AWAY and disarm the Omni security system using an ARM/DISARM TOGGLE (to ground) keyswitch or keypad.

### **PROGRAMMABLE ENERGY SAVER MODULE**

This zone type is for use with the Model 1101 PESM. It converts the zone and the corresponding Output to operate the Model 1101. Only zones 9-16 can be programmed as PESMs. Zone 9 and Output 1 are used together when Zone 9 is programmed as a PESM, Zone 10 and Output 2 are used together when Zone 10 is programmed as a PESM, and so on.

### **OUTDOOR TEMPERATURE**

Use this zone type for Outdoor Temperature Sensors.

### **TEMPERATURE**

The general-purpose TEMPERATURE ZONE type is typically used to monitor indoor temperatures and control devices. It sets the zone secure/not ready for program conditionals and event button activation.

If FREEZE ALARM is enabled, it reports a potential freeze condition if the temperature falls below 40°.





0-9999

x

## COMMUNICATOR TYPE

The Omni can transmit in both FAST 2300 Hz (20 PPS) mode, or in SLOW 1400 Hz (10 PPS) 3/1 format.

COMMUNICATOR TYPE:           0  
0=2300 1=1400                ×

The default setting is 0 = 2300 Hz. If you need to transmit to a 1400 Hz receiver, press 1 then '# '.

## TWO-WAY AUDIO

If a Two-Way Audio Module is being used, this item enables hands free audio communication between your customer's premises and the central station. After the transmission of the alarm to the central station, the operator can talk and listen to people and sounds at the premises.

TWO-WAY AUDIO:                0  
0=NO 1=YES                    ×

If a Two-Way Audio Module is part of the system, select the 1 (YES) key to enable this feature.

## REPORT OPEN/CLOSE

The communicator can be setup to send an opening and a closing report by user code. Whenever the system is disarmed the communicator will send an opening report to the central station. When the system is armed, the communicator will send a closing report to the central station.

REPORT OPEN/CLOSE:           0  
0=NO 1=YES                    ×

To enable the communicator to send opening and closing reports to the central station, select the 1 (YES) key.

## AUTOMATIC TEST TIME

The communicator can be setup to automatically send a test code to the central station on a periodic basis. AUTOMATIC TEST TIME is used to set the time and days of the week of the test, and the TEST CODE specifies the code that will be transmitted for the test.

AUTOMATIC TEST TIME:  
--           NEVER   #=CHNG×

To disable the automatic test, press the '# ' key and then 0 for Never, and '# '.

TEST CODE:                    98  
0-FF                           ×

## ALARM CODES

Press the down arrow (↓) to advance to the next ZONE ALARM CODE. Press the up arrow (↑) to go to the previous ZONE ALARM CODE. To change an alarm code, enter two digits for 4/2 format, or one digit when using 3/1 format, then press the '#' key.

Enter the 2 digit alarm code (1 digit if using 3/1 format) and press ' # '. To enter the digits B-F, first press the OFF key, then press the 1-5 key respectively (i.e. B1 = OFF 1 1 # and CB = OFF 2 OFF 1 #).

The various alarm codes are sent when the indicated alarm zone is tripped. Each alarm code must be two digits long for 4/2 format (01-FF), 1 digit for 3/1 format (1-F).

To disable the digital communicator for a specific zone, set the alarm code to 0 or 00. The digital dialer will not report when this zone is tripped.

**NOTE:** The Digital Communicator alarm codes are listed in the Appendix.  
(SEE DIGITAL COMMUNICATOR CODE SHEET)

ZONE 1 ALARM CODE: 01  
0-FF ×

THROUGH

USER 16 CLOSE CODE: 76  
0-FF ↑

## SETUP AREAS

To configure the system for multiple areas, from the Installer Setup menu, press the 4 (AREA) key. The number of areas must be specified. Also, consoles, zones, units, thermostats, and buttons must be assigned to areas. By default, the system is setup for one area.

The display prompts for the number of areas that will be used:

NUMBER OF AREAS: 1  
1-2

If you choose 2, the Setup Areas menu is displayed:

SETUP AREAS  
1=CTRL 2=ZONES 3=BTTN ↓  
4=CONS 5=TEMP  
↑

### SETUP AREAS: CONTROL

To assign control units to specific areas, from the Setup Areas menu, press the 1 (CTRL) key .

Units can be setup so that they can be activated from specific areas or from all areas.

Units for an entire X-10 house code can be assigned to specific areas. Units 33-40 may be assigned individually to specified areas.

UNITS 1-16 AREAS:  
1 2 0=CLR ↓

UNITS 17-32 AREAS:  
1 2 0=CLR ×

UNITS 33 AREAS:  
1 2 0=CLR ×

UNITS 34 AREAS:  
1 2 0=CLR ×

UNITS 35 AREAS:  
1 2 0=CLR ×

UNITS 36 AREAS:  
1 2 0=CLR ×

UNITS 37 AREAS:  
1 2 0=CLR ×

UNITS 38 AREAS:  
1 2 0=CLR ×

UNITS 39 AREAS:  
1 2 0=CLR ×

UNITS 40 AREAS:  
1 2 0=CLR ×

UNITS 41-48 AREAS:  
1 2 0=CLR ×

UNITS 49-56 AREAS:  
1 2 0=CLR ×

UNITS 57-64 AREAS:  
1 2 0=CLR ×

### SETUP AREAS: ZONES

To assign zones to areas, from the Setup Areas menu, press 2 (ZONE) . Each zone must be assigned to one and only one area.

ZONE 1 AREA: 1  
1-2 ↓

THROUGH

ZONE 32 AREA  
1-2

1  
↑

## SETUP AREAS: BUTTONS

To assign groups of macro buttons to specific areas, from the Setup Areas menu, press the 3 (BTTN) key.

Buttons can be setup so that they can only be activated from a particular area or from any area. Buttons are assigned to areas in groups of eight.

BUTTONS 1-8 AREAS:  
1 2                    0=CLR ↓

BUTTONS 9-16 AREAS:  
1 2                    0=CLR ×

BUTTONS 17-24 AREAS:  
1 2                    0=CLR ×

BUTTONS 25-32 AREAS:  
1 2                    0=CLR ↑

## SETUP AREAS: CONSOLES

To assign consoles to areas, from the Setup Areas menu, press the 4 (CONS) key.

Each console must be assigned to one and only one area. A console may be set to global, which allows it to access areas other than its assigned area through security arming and the "go to" function.

CONSOLE 1 AREA:            1  
1-2                        ↓

CONSOLE 1 GLOBAL:        1  
0=NO 1=YES                ×

CONSOLE 2 AREA:            1  
1-2                        ×

CONSOLE 2 GLOBAL:        1  
0=NO 1=YES                ×

CONSOLE 3 AREA:            1  
1-2                        ×

CONSOLE 3 GLOBAL:        1  
0=NO 1=YES                ×

CONSOLE 4 AREA:            1  
1-2                        ×

CONSOLE 4 GLOBAL:        1  
0=NO 1=YES                ×



CONSOLE 5 AREA: 1  
1-2 ×

CONSOLE 5 GLOBAL:	1
0=NO 1=YES	×
CONSOLE 6 AREA:	1
1-2	×
CONSOLE 6 GLOBAL:	1
0=NO 1=YES	×
CONSOLE 7 AREA:	1
1-2	×
CONSOLE 7 GLOBAL:	1
0=NO 1=YES	×
CONSOLE 8 AREA:	1
1-2	×
CONSOLE 8 GLOBAL:	1
0=NO 1=YES	↑

### SET-UP AREAS: THERMOSTATS

To assign thermostats to specific areas, from the Set-up Areas menu, press the 5 (TEMP) key.

Thermostats can be set up so that they can only be controlled from a specific area or from all areas. PESMs and Temperature Sensors can only be controlled from a single area, as specified in SET-UP AREAS.

THERMOSTAT 1 AREAS:	
1 2	0=CLR ↓
THERMOSTAT 2 AREAS:	
1 2	0=CLR ×
THERMOSTAT 3 AREAS:	
1 2	0=CLR ×
THERMOSTAT 4 AREAS:	
1 2	0=CLR ↑

### SETUP TEMPERATURES

To configure temperatures from the Installer Setup Menu, press the 5 (Temp) key.

### TEMPERATURE DISPLAY

This allows you to choose between Fahrenheit or Celsius temperature format.

TEMPERATURE DISPLAY: 1  
1=FAHRENHEIT 2=CELSIUS ↓

## NUMBER OF THERMOSTATS

You must specify the number of thermostats that are connected to Omni.

```
NUMBER OF TSTATS:      0
0-4                    ×
```

Up to four thermostats can be connected to Omni in System Mode.

## THERMOSTAT TYPE

This item specifies the thermostat type for each thermostat.

For thermostat types, the current setting is shown on the bottom line.

```
THERMOSTAT 1 TYPE:      1
AUTO HEAT/COOL  #=CHNG ×
```

## THROUGH

```
THERMOSTAT 4 TYPE:      1
AUTO HEAT/COOL  #=CHNG ↑
```

To change a thermostat type, use the arrow keys to scroll through the list of thermostat types, then press ' #' to select a new type. The display shows:

```
SELECT TYPE:            1
AUTO HEAT/COOL          ↓
```

TYPE	NUMBER	DESCRIPTION
AUTO HEAT/COOL	1	Automatic changeover heat and cool thermostat
HEAT/COOL	2	Manual changeover heat and cool thermostat
HEAT ONLY	3	Heating only thermostat
COOL ONLY	4	Cooling only thermostat
SETPOINT ONLY	5	Setpoint only thermostat

## SETUP MISCELLANEOUS

To configure the miscellaneous installer setup items, from the Installer Setup menu, press the 6 (MISC) key.

## INSTALLER CODE

The Installer code allows the installer access to the Installer Setup menu. The Installer code should be changed and not given to the customer.

```
INSTALLER CODE:
0000-9999  0000=DISABLE↓
```

The default setting for the Installer code is 1 1 1 1.

**NOTE:**

Remember this Installer code. There is no way to reset or retrieve the code! If the code is forgotten, the Omni controller must be sent back to the factory. Call for an RA#.

**ENABLE PC ACCESS**

This enables or disables the PC ACCESS feature. Set to 0 to disable PC ACCESS, set to 1 to enable PC ACCESS. Factory default is enabled.

ENABLE PC ACCESS: 1  
0=NO 1=YES x

**PC ACCESS CODE:**

This code allows dealers to put an access code in the system that is separate from the customer's Master code and the Installer code. Dealers can use the PC Access code to access the system by PC. The PC Access code cannot arm and disarm the system. The PC Access code is NOT programmed from the factory. To use it, set any code other than 0000 in PC Access code. To disable the PC Access code, enter 0000 for the code.

NOTE: This item must be enabled (by entering a code) if PC Access is will be used.

PC ACCESS CODE:  
0000-9999 0000=DISABLEx

**CALL BACK PHONE NUMBER**

In response to a request for remote PC ACCESS using the PC ACCESS code, the system will hang up and dial this number back immediately. To program the Callback Phone Number, enter the number then press ' # '. To remove the CALLBACK PHONE NUMBER, press the OFF key to enter a single "-", then press ' # '.

CALL BACK PHONE NUMBER:  
- x

**OUTSIDE SIREN DELAY**

When the alarm is "tripped" (activated by a burglar or fire) the interior sounder will sound first, then the outside siren will sound after the Outside Siren Delay. This feature helps reduce annoying false alarms by signaling inside the premises first.

The outside siren delay is set to 15 seconds at the factory. You may change it to any value from 0 to 60 seconds. If you want the outside siren to sound immediately when the alarm is activated, set the delay to zero. We recommend a minimum time of 15 seconds.

To change the Outside Siren Delay, press the desired outside siren delay in seconds, then press the ' # ' key.

DIAL OUT DELAY: 15  
0-60 SECONDS x

## DIAL OUT DELAY

The Dial Out Delay is the number of seconds that the Omni waits before making an emergency dial out, AFTER the alarm is "tripped" (activated by burglar or fire).

This delay is set at the factory to 15 seconds. We recommend a minimum time of 15 seconds to preclude an accidental activation of the alarm from calling in a false alarm.

To set the dial out delay, enter the desired dial out delay in seconds, then press the '#' key.

DIAL OUT DELAY:           15  
0-60 SECONDS                ×

## ALARM RESET TIME

The Alarm Reset Time is the time it takes before the alarm system resets itself after the outside siren is activated due to a security violation.

ALARM RESET TIME:         4  
1-30 MINUTES                ×

To change the alarm reset time, enter a new time between 1-30 minutes, then press the '#' key. The default setting is 4 minutes.

## ARMING CONFIRMATION

The Arming Confirmation is a quick pulse (squawk) given by the outside siren when the alarm system is armed into a security mode and the EXIT DELAY is expired.

ARMING CONFIRMATION:     0  
0=NO 1=YES                 ×

To enable the arming confirmation feature, press the 1 (YES) key, then press the '#' key. The default setting is 0 (NO) disabled.

## FIRE ALARM VERIFICATION

This unit is equipped with a FIRE ALARM VERIFICATION feature. When a zone configured as a FIRE (Type 32) or a GAS (Type 34) is activated, the system will cycle the SWITCH 12V power output off for 10 seconds. The SWITCH 12V power output will then be restored, and 5 seconds later, the zones will be monitored again. If the zone is activated again within a 2 minute window, the fire alarm will be activated. If not, no fire alarm will be indicated.

VERIFY FIRE ALARMS:     1  
0=NO 1=YES                 ×

**NOTE:**

If VERIFY FIRE ALARMS is turned ON, **any** device (other than FIRE or GAS) connected to SWITCH 12V (i.e. Glassbreak Detectors) must be connected to a zone configured as a LATCHING ZONE TYPE.

This feature is designed to reduce false alarms and is turned ON by factory default. To turn it OFF, set VERIFY FIRE ALARMS to NO.

The following notice is required by UL:

**WARNING**

This unit includes an alarm verification feature that will result in a delay of the system fire alarm signal from the initiating circuit. The total delay (Omni controller plus detector delay) shall not exceed 60 seconds. No other initiating devices shall be connected to these circuits unless approved by the local authority having jurisdiction.

Zone Circuit	Control Unit Delay	Detector Delay	Total Delay
_____	: 10 seconds	+ _____	= _____
_____	: 10 seconds	+ _____	= _____
_____	: 10 seconds	+ _____	= _____
_____	: 10 seconds	+ _____	= _____

**ENABLE EMERGENCY KEYS**

This enables or disables the emergency keys on the console keypad to be functional. Select the 1 (YES) key to enable the emergency keys. Select the 2 (NO) key to disable the emergency keys. Factory default is enabled.

ENABLE EMERG KEYS:            1  
0=NO 1=YES                    ×

**TIME DISPLAY**

This allows you to choose between AM/PM or 24 HOUR time format.

TIME DISPLAY:                    1  
1=AM/PM 2=24HR                ×

**DATE DISPLAY**

This allows you to choose between MONTH/DAY or DAY/MONTH date format.

DATE DISPLAY:                    1  
1=MMDD 2=DDMM                ×



## AC POWER FREQUENCY

Set this to the appropriate frequency.

AC POWER FREQUENCY: 1  
1=60HZ 2=50HZ ×

## DEAD LINE DETECT

NOTE: Adjust only under direction of Home Automation, Inc.

This item adjusts the threshold that is used to determine when the phone line goes dead.

DEAD LINE DETECT: 8  
0-15 0=DISABLE ×

## OFF HOOK DETECT

NOTE: Adjust only under direction of Home Automation, Inc.

This item adjusts the threshold that is used to determine when the phone line is going off hook.

OFF HOOK DETECT: 69  
20-250 ×

## PICKUP AFTER HANGUP

This item is used to disable Omni from picking up the phone line after the called party hangs up the line.

PICKUP AFTER HANGUP: 1  
0=NO 1=YES ×

Currently, after the called party or the called party's answering machine hangs up the phone line, Omni picks up the line and make its "Beep". If you wish to turn the Pickup After Hangup Off, press 0 then '#'. To turn it back On, press 1 then '# '.

The default setting for Pickup After Hangup is Yes.

## CLOCK ADJUSTMENT

If the clock on an Omni is running faster or slower than the actual time, you can have the Omni automatically compensate up to 29 seconds per day. The Omni will add or subtract the selected amount of time daily.

CLOCK ADJUSTMENT: 30  
1-59=-29 TO +29 SEC/DAY×

Enter 1-29 to subtract 1-29 seconds. Enter 31-59 to add 1-29 seconds. Enter 30 for no adjustment to the clock.

The default setting is 30.

## MODEL AND SOFTWARE VERSION

Next, the model number and software version for the system is displayed:

```
HAI OMNI
S/W VERSION 1.4      ×
```

## RESET SYSTEM EEPROM

Select the 1 (YES) key to reset the EEPROM . All programs, names, and setup items will be reset. All system RAM will also be initialized and the system will restart. This option, if effect, allows the system to be restored to factory fresh configuration.

```
RESET SYSTEM EEPROM?  0
0=NO  1=YES           ×
```

## RESET SYSTEM RAM

Select the 1 (YES) key to cause all of the system RAM to be reinitialized. The time, date, and event log will be cleared. Other volatile memory locations will also be reinitialized. The system RAM should only be reset if the system is acting strangely and memory corruption is suspected. Resetting the system RAM will not reset any setup items stored in EEPROM.

```
RESET SYSTEM RAM?    0
0=NO  1=YES          ↑
```

## SETUP EXPANSION

To configure each expansion module that is installed on a system, from the Installer Setup menu, press the 7 (EXP) key.

### MODULE 1 TYPE

The Module Type defines the function of each expansion module on the controller. Module 1 is the module with the ADDR jumper set to 1. Set the module type from the list below. Press # to change the module type, then use the arrow keys to select the proper module type, then press # to enter.

```
MODULE 1 TYPE        1
HARDWIRE EXPNDR #=CHNG ↓
```

Select from the following for the module with jumper set to 1:

MODULE TYPES	NUMBER	DESCRIPTION
NOT USED	0	No module is installed
HARDWIRE EXPNDR	1	Model 10A06 Hardwire Expander is nstalled
OMNI-LINK	3	Model 10A17 Serial Interface using Omni-Link protocol

**MODULE 2 TYPE through MODULE 4 TYPE**

Module 2 is the module with the jumper set to 2, and so on. Set each module type from the list above.

**SERIAL 1 RATE**

Select the baud rate for the first serial interface from the list below. Use the arrow keys to select the baud rate then press #.

<b>BAUD RATE</b>	<b>NUMBER</b>
75 baud	1
150 baud	2
300 baud	3
600 baud	4
1200 baud	5
2400 baud	6
4800 baud	7
9600 baud	8 (default)

## OMNI SPECIFICATIONS

Size: Controller: 13 W x 13 H x 4.5 D  
Console: 4.6 W x 4.5 H x 1.2 D

Weight: Controller: approx. 10 lb.  
Console: approx. 0.5 lb.

Operating 32 - 122 degrees F (0 - 50 degrees C)  
Ranges: 10 - 95 % relative humidity, non-condensing

Power: 120 VAC, 60 Hz, 60 watts

Transformer: 24 VAC, 1.67 amps, 40 VA

Battery: Rechargeable gel-cell, 12 volts, 7 amp-hour

Main Fuse: On Controller: Type 3 AG, 2 A fast blow

Battery Fuse: On Controller: Type 3 AG, 5 A fast blow

Device Fuse: Polyfuse: 1.35 A

Horns Fuse: Polyfuse: 1.35 A

Polyfuses are permanent fuses that do not need replacement.

Nominal Voltage: 10 - 13.7 VDC, 0.5 V max. peak to peak ripple

Low Voltage Cut Out: approx. 9 VDC

Typical Current Consumption at Nominal Voltage:

Controller: 275 mA  
Console: backlight off, 35 mA  
backlight on, 100 mA

Controller Maximum Group Current Outputs:

Devices: AUX 12 VDC, SWITCH 12 VDC,  
CONSOLE, and OUTPUTS 1 - 8: 1 A

Horn: INT HORN and EXT HORN: 1 A

Controller Maximum Individual Current Outputs:

Devices: **(Do not exceed 1 A total)**

AUX 12 VDC 1 A  
SWITCH 12 VDC 1 A

CONSOLE  
OUTPUTS 1 - 8

1 A  
100 mA

MINIMUM Battery Backup Time: 4 hours/24 hours (See Figure 10)

## UNDERWRITER'S LABORATORIES (UL) INSTALLATION REQUIREMENTS

The Omni control units (10A00-1 and -4) are suitable for Grade A household burglar and fire applications. Refer to UL1641 for installation requirements. Model 10A00-4 is also suitable for use in Commercial Burglar Alarm Applications, Grade B Central Station, Grade A Local, and Grade A Police Connect. Refer to UL 681 for Installation Requirements.

1. The line carrier (X-10) operation is considered supplementary. Operation of the line carrier devices was not investigated by UL.
2. For those zones programmed as PANIC, DURESS or POLICE EMERGENCY, the initiating device shall be a UL Listed Hold Up Device switch.
3. Connections to phone circuit must be made via the supplied cable and RJ31X Jack as shown under RJ31X JACK CONNECTIONS in this manual.
4. For connection of smoke detectors to the controller, refer to requirements under FIRE ZONE HOOKUP and FIRE ZONE CONNECTIONS diagrams in this manual.
5. The controller must be configured for 24 hour Standby Time as shown under 24 HR STANDBY CONNECTIONS diagram in this manual. Maximum current ratings for 24 hours must be observed.
6. Recognized energy limited cable shall be employed, 22 AWG minimum for all connections.
7. The audible signal appliance shall be the Listed Wheelock Model 34T-12 Fire Horn, rated 9 - 15.6 VDC, 85 dB(A) with 2 reflecting planes. This horn shall be connected to a supervisory zone as shown in Figure 6. The zone shall be configured as a FIRE TAMPER zone type. The audible signal shall be mounted indoors in a central location. The audible signal appliance can be connected to either the "HORNS-INT" or "HORNS-EXT" circuits. In the case of the latter, the OUTSIDE SIREN DELAY shall be set to 0 seconds.
8. For Commercial Applications, Listed Ademco AB12 Bell and housing to be used.
9. If the remote arm/disarm switch is used, it shall be the Listed Ademco Model 9789.
10. Operation of the controls with the Model 1101 energy saver module was not conducted by UL.
11. Refer to the Omni Owner's Manual (Document No. 10R00) for programming requirements in UL Listed Installations.
12. For the monitoring of burglar alarm initiating devices, the zone type shall provide an audible output (i.e., not DURESS).
13. The Omni controller must be connected (when employed) to listed gas detectors.
14. All connections to energy sensors and modules must be done to listed Class 2 circuits only.
15. The Omni must be used in Residential Applications that are under a single ownership.

When used in UL Listed Installations, the following items apply:

1. The "High Security Mode" must be ON.
2. The "Enable Auto Bypass" feature must be OFF.
3. The ENTRY DELAY shall not exceed 45 seconds for Residential Applications; 60 seconds for Commercial Applications.
4. The EXIT DELAY shall not exceed 60 seconds.

5. Double Delay and Quad Delay zone types shall not be used.
6. For Residential Applications the sounding device may be mounted indoors. If, however, the sounding device is connected to the "EXT HORN" terminals of the Omni, then the OUTSIDE SIREN DELAY shall be set to 0.
7. The BEEP ON TROUBLE feature must be ON.
8. Installer: NAME: \_\_\_\_\_ NUMBER: \_\_\_\_\_

Maximum current ratings for 24 hours:

Aux 12 VDC, Switch 12 VDC, Console, Outputs 1-8: 250 mA

Interior Horn and Exterior Horn: 350 mA

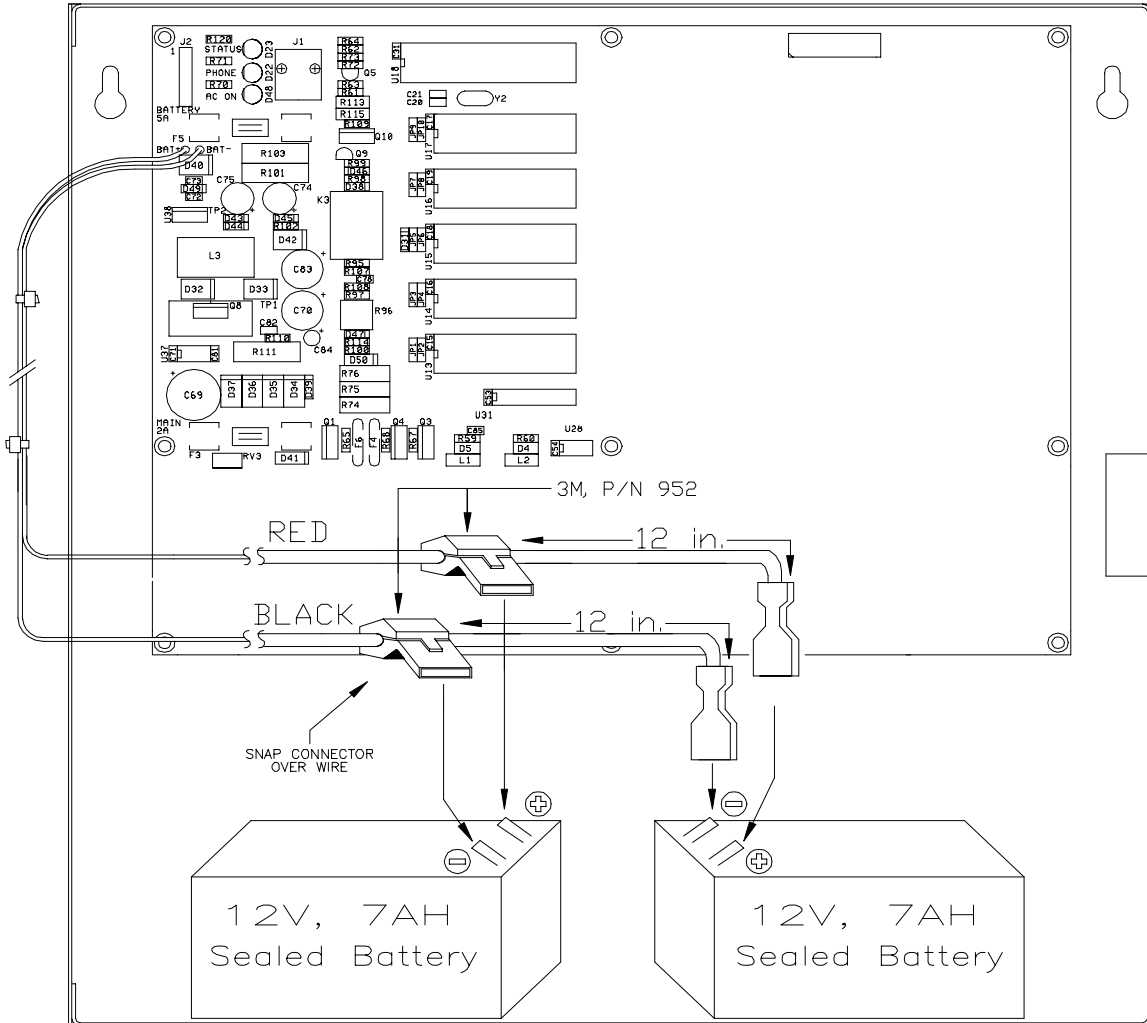
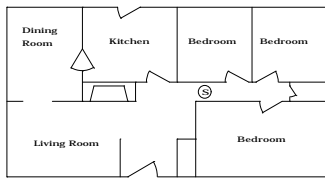

**FIGURE 10**  
**24 HR STANDBY CONNECTIONS**



## SMOKE DETECTOR INSTALLATION GUIDELINES

1. Ceiling mounted smoke detectors should be located in the center of the room or hall, or not less than 4 inches from any wall. When the detector is mounted on a wall, the top of the detector should be 4 to 12 inches from the ceiling.
2. Do not install smoke detectors where normal ambient temperatures are above 100 deg. F (37.8 deg. C) or below 40 deg. F (4 deg. C). Also, do not locate the detector in front of air conditioners, heating registers, or other locations where normal air circulation will keep smoke from entering the detector.
3. Additional information on Household Fire Warning is available at nominal cost from: The National Fire Protection Association, Battery March Park, Quincy, MA. 02269. Request Standard No. NFPA 72. Contact your home Insurance Company for a possible reduction of your insurance premium.
4. A smoke detector should be located between the sleeping area and the rest of the family living unit.
5. In family living units with more than one sleeping area, a smoke detector should be provided to protect each sleeping area.
6. A smoke detector should be located on each story (Refer to the diagrams below).
7. For complete details on proper location and installation of smoke detectors, refer to the instructions supplied with the smoke detector.



(a) A smoke detector should be located between the sleeping area and the rest of the family living unit.

(b) Where to Locate the Required Smoke Detectors in New Construction. All of the smoke detectors specified in (a) for existing construction are required, and, in addition, a smoke detector is required in each bedroom.

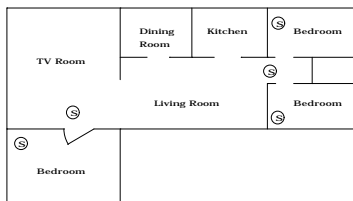

(b) In family living units with more than one sleeping area, a smoke detector should be provided to protect each sleeping area in addition to detectors required in bedrooms.

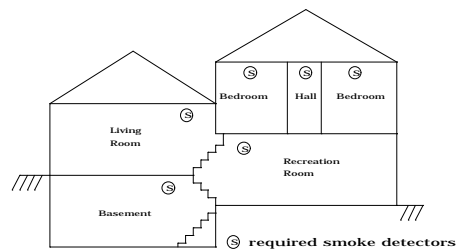

Split level arrangement. Smoke detectors are required where shown. Smoke detectors are optional if door is not provided between living and recreation rooms.

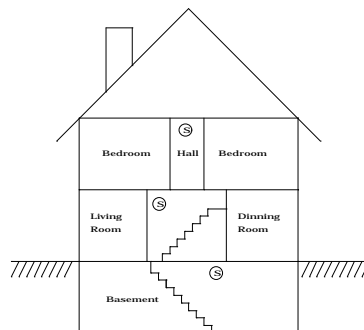

A smoke detector should be located on each story.



**OMNI INSTALLATION PLANNER / CHECKLIST**

ZONE 1 NAME: \_\_\_\_\_ TYPE: \_\_\_\_\_ AREA: \_\_\_\_\_

VOICE: \_\_\_\_\_ LOCATION: \_\_\_\_\_ TESTED: \_\_\_\_\_

ZONE 2 NAME: \_\_\_\_\_ TYPE: \_\_\_\_\_ AREA: \_\_\_\_\_

VOICE: \_\_\_\_\_ LOCATION: \_\_\_\_\_ TESTED: \_\_\_\_\_

ZONE 3 NAME: \_\_\_\_\_ TYPE: \_\_\_\_\_ AREA: \_\_\_\_\_

VOICE: \_\_\_\_\_ LOCATION: \_\_\_\_\_ TESTED: \_\_\_\_\_

ZONE 4 NAME: \_\_\_\_\_ TYPE: \_\_\_\_\_ AREA: \_\_\_\_\_

VOICE: \_\_\_\_\_ LOCATION: \_\_\_\_\_ TESTED: \_\_\_\_\_

ZONE 5 NAME: \_\_\_\_\_ TYPE: \_\_\_\_\_ AREA: \_\_\_\_\_

VOICE: \_\_\_\_\_ LOCATION: \_\_\_\_\_ TESTED: \_\_\_\_\_

ZONE 6 NAME: \_\_\_\_\_ TYPE: \_\_\_\_\_ AREA: \_\_\_\_\_

VOICE: \_\_\_\_\_ LOCATION: \_\_\_\_\_ TESTED: \_\_\_\_\_

ZONE 7 NAME: \_\_\_\_\_ TYPE: \_\_\_\_\_ AREA: \_\_\_\_\_

VOICE: \_\_\_\_\_ LOCATION: \_\_\_\_\_ TESTED: \_\_\_\_\_

ZONE 8 NAME: \_\_\_\_\_ TYPE: \_\_\_\_\_ AREA: \_\_\_\_\_

VOICE: \_\_\_\_\_ LOCATION: \_\_\_\_\_ TESTED: \_\_\_\_\_

ZONE 9 NAME: \_\_\_\_\_ TYPE: \_\_\_\_\_ AREA: \_\_\_\_\_

VOICE: \_\_\_\_\_ LOCATION: \_\_\_\_\_ TESTED: \_\_\_\_\_

ZONE 10 NAME: \_\_\_\_\_ TYPE: \_\_\_\_\_ AREA: \_\_\_\_\_

VOICE: \_\_\_\_\_ LOCATION: \_\_\_\_\_ TESTED: \_\_\_\_\_

ZONE 11 NAME: \_\_\_\_\_ TYPE: \_\_\_\_\_ AREA: \_\_\_\_\_

VOICE: \_\_\_\_\_ LOCATION: \_\_\_\_\_ TESTED: \_\_\_\_\_

ZONE 12 NAME: \_\_\_\_\_ TYPE: \_\_\_\_\_ AREA: \_\_\_\_\_

VOICE: \_\_\_\_\_ LOCATION: \_\_\_\_\_ TESTED: \_\_\_\_\_

ZONE 13 NAME: \_\_\_\_\_ TYPE: \_\_\_\_\_ AREA: \_\_\_\_\_

VOICE: \_\_\_\_\_ LOCATION: \_\_\_\_\_ TESTED: \_\_\_\_\_

ZONE 14 NAME: \_\_\_\_\_ TYPE: \_\_\_\_\_ AREA: \_\_\_\_\_

VOICE: \_\_\_\_\_ LOCATION: \_\_\_\_\_ TESTED: \_\_\_\_\_

ZONE 15 NAME: \_\_\_\_\_ TYPE: \_\_\_\_\_ AREA: \_\_\_\_\_

VOICE: \_\_\_\_\_ LOCATION: \_\_\_\_\_ TESTED: \_\_\_\_\_

ZONE 16 NAME: \_\_\_\_\_ TYPE: \_\_\_\_\_ AREA: \_\_\_\_\_

VOICE: \_\_\_\_\_ LOCATION: \_\_\_\_\_ TESTED: \_\_\_\_\_

**ZONE EXPANSION:**

HARDWIRE EXPANDER \_\_\_\_\_ WIRELESS RECEIVER \_\_\_\_\_

ZONE 17 NAME: \_\_\_\_\_ TYPE: \_\_\_\_\_ AREA: \_\_\_\_\_

VOICE: \_\_\_\_\_ LOCATION: \_\_\_\_\_ TESTED: \_\_\_\_\_

ZONE 18 NAME: \_\_\_\_\_ TYPE: \_\_\_\_\_ AREA: \_\_\_\_\_

VOICE: \_\_\_\_\_ LOCATION: \_\_\_\_\_ TESTED: \_\_\_\_\_

ZONE 19 NAME: \_\_\_\_\_ TYPE: \_\_\_\_\_ AREA: \_\_\_\_\_

VOICE: \_\_\_\_\_ LOCATION: \_\_\_\_\_ TESTED: \_\_\_\_\_

ZONE 20 NAME: \_\_\_\_\_ TYPE: \_\_\_\_\_ AREA: \_\_\_\_\_

VOICE: \_\_\_\_\_ LOCATION: \_\_\_\_\_ TESTED: \_\_\_\_\_

ZONE 21 NAME: \_\_\_\_\_ TYPE: \_\_\_\_\_ AREA: \_\_\_\_\_

VOICE: \_\_\_\_\_ LOCATION: \_\_\_\_\_ TESTED: \_\_\_\_\_

ZONE 22 NAME: \_\_\_\_\_ TYPE: \_\_\_\_\_ AREA: \_\_\_\_\_

VOICE: \_\_\_\_\_ LOCATION: \_\_\_\_\_ TESTED: \_\_\_\_\_

ZONE 23 NAME: \_\_\_\_\_ TYPE: \_\_\_\_\_ AREA: \_\_\_\_\_

VOICE: \_\_\_\_\_ LOCATION: \_\_\_\_\_ TESTED: \_\_\_\_\_

ZONE 24 NAME: \_\_\_\_\_ TYPE: \_\_\_\_\_ AREA: \_\_\_\_\_

VOICE: \_\_\_\_\_ LOCATION: \_\_\_\_\_ TESTED: \_\_\_\_\_

ZONE 25 NAME: \_\_\_\_\_ TYPE: \_\_\_\_\_ AREA: \_\_\_\_\_

VOICE: \_\_\_\_\_ LOCATION: \_\_\_\_\_ TESTED: \_\_\_\_\_

ZONE 26 NAME: \_\_\_\_\_ TYPE: \_\_\_\_\_ AREA: \_\_\_\_\_

VOICE: \_\_\_\_\_ LOCATION: \_\_\_\_\_ TESTED: \_\_\_\_\_

ZONE 27 NAME: \_\_\_\_\_ TYPE: \_\_\_\_\_ AREA: \_\_\_\_\_

VOICE: \_\_\_\_\_ LOCATION: \_\_\_\_\_ TESTED: \_\_\_\_\_

ZONE 28 NAME: \_\_\_\_\_ TYPE: \_\_\_\_\_ AREA: \_\_\_\_\_

VOICE: \_\_\_\_\_ LOCATION: \_\_\_\_\_ TESTED: \_\_\_\_\_

ZONE 29 NAME: \_\_\_\_\_ TYPE: \_\_\_\_\_ AREA: \_\_\_\_\_

VOICE: \_\_\_\_\_ LOCATION: \_\_\_\_\_ TESTED: \_\_\_\_\_

ZONE 30 NAME: \_\_\_\_\_ TYPE: \_\_\_\_\_ AREA: \_\_\_\_\_

VOICE: \_\_\_\_\_ LOCATION: \_\_\_\_\_ TESTED: \_\_\_\_\_

ZONE 31 NAME: \_\_\_\_\_ TYPE: \_\_\_\_\_ AREA: \_\_\_\_\_

VOICE: \_\_\_\_\_ LOCATION: \_\_\_\_\_ TESTED: \_\_\_\_\_

ZONE 32 NAME: \_\_\_\_\_ TYPE: \_\_\_\_\_ AREA: \_\_\_\_\_

VOICE: \_\_\_\_\_ LOCATION: \_\_\_\_\_ TESTED: \_\_\_\_\_

**INTERIOR SOUNDER:**

LOCATION: \_\_\_\_\_

TESTED: \_\_\_\_\_

**OUTDOOR SIREN:**

LOCATION: \_\_\_\_\_

TESTED: \_\_\_\_\_

**CONSOLE 1:**

LOCATION: \_\_\_\_\_ AREA: \_\_\_\_\_ TESTED: \_\_\_\_\_

**CONSOLE 2:**

LOCATION: \_\_\_\_\_ AREA: \_\_\_\_\_ TESTED: \_\_\_\_\_

**CONSOLE 3:**

LOCATION: \_\_\_\_\_ AREA: \_\_\_\_\_ TESTED: \_\_\_\_\_

**CONSOLE 4:**

LOCATION: \_\_\_\_\_ AREA: \_\_\_\_\_ TESTED: \_\_\_\_\_

**CONSOLE 5:**

LOCATION: \_\_\_\_\_ AREA: \_\_\_\_\_ TESTED: \_\_\_\_\_



**CONSOLE 6:**

LOCATION: \_\_\_\_\_ AREA: \_\_\_\_\_ TESTED: \_\_\_\_\_

**CONSOLE 7:**

LOCATION: \_\_\_\_\_ AREA: \_\_\_\_\_ TESTED: \_\_\_\_\_

**CONSOLE 8:**

LOCATION: \_\_\_\_\_ AREA: \_\_\_\_\_ TESTED: \_\_\_\_\_

Console addresses set differently ?

\_\_\_\_\_

**CONTROLLER POWER UP**

System Grounded to good ground ?

\_\_\_\_\_

Runs with battery disconnected ?

\_\_\_\_\_

Runs on battery with transformer unplugged ?

\_\_\_\_\_

**TELEPHONE CHECKOUT**

TELCO surge arrestor properly grounded ?

\_\_\_\_\_

Incoming lines to TELCO arrestor first ?

\_\_\_\_\_

PHONE LINE LED off when phones are hung up ?

\_\_\_\_\_

Voice menu on in-house phones ?

\_\_\_\_\_

Customer's ADDRESS in memory (# 8 8) ?

\_\_\_\_\_

(# 8 9 + Master code to record)

All in-house phones checked ?

\_\_\_\_\_



**CONTROL CHECK OUT**

HOUSE CODE: \_\_\_\_\_ set to AREA: \_\_\_\_\_

TESTED	LOCATION
Unit #1: _____	_____
Unit #2: _____	_____
Unit #3: _____	_____
Unit #4: _____	_____
Unit #5: _____	_____
Unit #6: _____	_____
Unit #7: _____	_____
Unit #8: _____	_____
Unit #9: _____	_____
Unit #10: _____	_____
Unit #11: _____	_____
Unit #12: _____	_____
Unit #13: _____	_____
Unit #14: _____	_____
Unit #15: _____	_____
Unit #16: _____	_____

For UNIT NUMBERS 17-32 the House Code is automatically set to one greater than the house code used above. This group is set to AREA: \_\_\_\_\_

Unit #17: _____	_____
Unit #18: _____	_____

Unit #19: \_\_\_\_\_  
Unit #20: \_\_\_\_\_  
Unit #21: \_\_\_\_\_  
Unit #22: \_\_\_\_\_  
Unit #23: \_\_\_\_\_  
Unit #24: \_\_\_\_\_  
Unit #25: \_\_\_\_\_  
Unit #26: \_\_\_\_\_  
Unit #27: \_\_\_\_\_  
Unit #28: \_\_\_\_\_  
Unit #29: \_\_\_\_\_  
Unit #30: \_\_\_\_\_  
Unit #31: \_\_\_\_\_  
Unit #32: \_\_\_\_\_

Unit #33: \_\_\_\_\_ Type: \_\_\_\_\_ Area: \_\_\_\_\_  
Unit #34: \_\_\_\_\_ Type: \_\_\_\_\_ Area: \_\_\_\_\_  
Unit #35: \_\_\_\_\_ Type: \_\_\_\_\_ Area: \_\_\_\_\_  
Unit #36: \_\_\_\_\_ Type: \_\_\_\_\_ Area: \_\_\_\_\_  
Unit #37: \_\_\_\_\_ Type: \_\_\_\_\_ Area: \_\_\_\_\_  
Unit #38: \_\_\_\_\_ Type: \_\_\_\_\_ Area: \_\_\_\_\_  
Unit #39: \_\_\_\_\_ Type: \_\_\_\_\_ Area: \_\_\_\_\_  
Unit #40: \_\_\_\_\_ Type: \_\_\_\_\_ Area: \_\_\_\_\_

Energy Savers On, HVAC OFF tested \_\_\_\_\_

**CUSTOMER INFORMATION**

- Customer knows how to arm/disarm ? \_\_\_\_\_
- Customer knows how to change codes ? \_\_\_\_\_
- Customer knows how to get menu on phone ? \_\_\_\_\_
- Customer satisfied with installation ? \_\_\_\_\_
- Customer Manual Delivered ? \_\_\_\_\_
- Tools/trash picked up ? \_\_\_\_\_

NOTES: \_\_\_\_\_  
\_\_\_\_\_  
\_\_\_\_\_  
\_\_\_\_\_  
\_\_\_\_\_  
\_\_\_\_\_  
\_\_\_\_\_  
\_\_\_\_\_  
\_\_\_\_\_  
\_\_\_\_\_  
\_\_\_\_\_  
\_\_\_\_\_  
\_\_\_\_\_  
\_\_\_\_\_  
\_\_\_\_\_  
\_\_\_\_\_  
\_\_\_\_\_  
\_\_\_\_\_  
\_\_\_\_\_

\_\_\_\_\_  
Installer

\_\_\_\_\_  
Signature

\_\_\_\_\_  
Date

**DIGITAL COMMUNICATOR CODE SHEET  
INFORMATION FOR CENTRAL STATION**

Date: \_\_\_\_\_

Subscriber Name: \_\_\_\_\_  
Address 1: \_\_\_\_\_  
Address 2: \_\_\_\_\_  
City, State, Zip: \_\_\_\_\_  
Home #: \_\_\_\_\_ Work #: \_\_\_\_\_  
Password: \_\_\_\_\_

Installer Name: \_\_\_\_\_  
Address 1: \_\_\_\_\_  
Address 2: \_\_\_\_\_  
City, State, Zip: \_\_\_\_\_  
Phone #: \_\_\_\_\_ Beeper #: \_\_\_\_\_

Subscriber's Notification List:

1. Name: \_\_\_\_\_  
Phone #: \_\_\_\_\_  
Relationship: \_\_\_\_\_
2. Name: \_\_\_\_\_  
Phone #: \_\_\_\_\_  
Relationship: \_\_\_\_\_
3. Name: \_\_\_\_\_  
Phone #: \_\_\_\_\_  
Relationship: \_\_\_\_\_

Subscriber Equipment: Home Automation, Inc. - Omni

Notes: \_\_\_\_\_  
\_\_\_\_\_  
\_\_\_\_\_

First Phone #: \_\_\_\_\_  
First Account #: \_\_\_\_\_  
Second (Backup) Phone #: \_\_\_\_\_  
Second (Backup) Account #: \_\_\_\_\_

Communicator Type (1400 Hz or 2300 Hz): \_\_\_\_\_

TWO-WAY AUDIO: \_\_\_\_\_ YES \_\_\_\_\_ NO  
REPORT OPEN/CLOSE: \_\_\_\_\_ YES \_\_\_\_\_ NO

24 HOUR TEST: \_\_\_\_\_ YES \_\_\_\_\_ NO TEST TIME: \_\_\_\_\_

<b>CODE</b>	<b>ZONE</b>	<b>DESCRIPTION</b>	<b>ACTION TO TAKE</b>
98	TEST CODE	_____	_____
01	ZONE 1:	_____	_____
02	ZONE 2:	_____	_____
03	ZONE 3:	_____	_____
04	ZONE 4:	_____	_____
05	ZONE 5:	_____	_____
06	ZONE 6:	_____	_____
07	ZONE 7:	_____	_____
08	ZONE 8:	_____	_____
09	ZONE 9:	_____	_____
10	ZONE 10:	_____	_____
11	ZONE 11:	_____	_____
12	ZONE 12:	_____	_____
13	ZONE 13:	_____	_____
14	ZONE 14:	_____	_____
15	ZONE 15:	_____	_____
16	ZONE 16:	_____	_____
17	ZONE 17:	_____	_____
18	ZONE 18:	_____	_____
19	ZONE 19:	_____	_____
20	ZONE 20:	_____	_____
21	ZONE 21:	_____	_____
22	ZONE 22:	_____	_____
23	ZONE 23:	_____	_____
24	ZONE 24:	_____	_____

<b>CODE</b>	<b>ZONE</b>	<b>DESCRIPTION</b>	<b>ACTION TO TAKE</b>
25	ZONE 25:		
26	ZONE 26:		
27	ZONE 27:		
28	ZONE 28:		
29	ZONE 29:		
30	ZONE 30:		
31	ZONE 31:		
32	ZONE 32:		
81	FREEZE ALARM		
82	FIRE EMERG		
83	POLICE EMERG		
84	AUX EMERG		
85	DURESS		
86	BATTERY LOW		
87	FIRE ZONE TROUBLE		
99	CANCEL CODE		
40	OTHER OPEN		
41	USER 1 OPEN		
42	USER 2 OPEN		
43	USER 3 OPEN		
44	USER 4 OPEN		
45	USER 5 OPEN		
46	USER 6 OPEN		
47	USER 7 OPEN		
48	USER 8 OPEN		

<b>CODE</b>	<b>ZONE</b>	<b>DESCRIPTION</b>	<b>ACTION TO TAKE</b>
49	USER 9 OPEN		
50	USER 10 OPEN		
51	USER 11 OPEN		
52	USER 12 OPEN		
53	USER 13 OPEN		
54	USER 14 OPEN		
55	USER 15 OPEN		
56	USER 16 OPEN		
60	OTHER CLOSE		
61	USER 1 CLOSE		
62	USER 2 CLOSE		
63	USER 3 CLOSE		
64	USER 5 CLOSE		
65	USER 5 CLOSE		
66	USER 6 CLOSE		
67	USER 7 CLOSE		
68	USER 8 CLOSE		
69	USER 9 CLOSE		
70	USER 10 CLOSE		
71	USER 11 CLOSE		
72	USER 12 CLOSE		
73	USER 13 CLOSE		
74	USER 14 CLOSE		
75	USER 15 CLOSE		
76	USER 16 CLOSE		