



**Fire Alarm Control Panel
MS-2410B &
MS-2410BE**

Fire Alarm System Limitations

An automatic fire alarm system—typically made up of smoke detectors, heat detectors, manual pull stations, audible warning devices, and a fire alarm control with remote notification capability—can provide early warning of a developing fire. Such a system, however, does not assure protection against property damage or loss of life resulting from a fire.

The Manufacturer recommends that smoke and/or heat detectors be located throughout a protected premise following the recommendations of the current edition of the National Fire Protection Association Standard 72 (NFPA 72), manufacturer's recommendations, State and local codes, and the recommendations contained in the Guide for Proper Use of System Smoke Detectors, which is made available at no charge to all installing dealers. A study by the Federal Emergency Management Agency (an agency of the United States government) indicated that smoke detectors may not go off in as many as 35% of all fires. While fire alarm systems are designed to provide early warning against fire, they do not guarantee warning or protection against fire. A fire alarm system may not provide timely or adequate warning, or simply may not function, for a variety of reasons:

Smoke detectors may not sense fire where smoke cannot reach the detectors such as in chimneys, in or behind walls, on roofs, or on the other side of closed doors. Smoke detectors also may not sense a fire on another level or floor of a building. A second-floor detector, for example, may not sense a first-floor or basement fire.

Particles of combustion or "smoke" from a developing fire may not reach the sensing chambers of smoke detectors because:

- Barriers such as closed or partially closed doors, walls, or chimneys may inhibit particle or smoke flow.
- Smoke particles may become "cold," stratify, and not reach the ceiling or upper walls where detectors are located.
- Smoke particles may be blown away from detectors by air outlets.
- Smoke particles may be drawn into air returns before reaching the detector.

The amount of "smoke" present may be insufficient to alarm smoke detectors. Smoke detectors are designed to alarm at various levels of smoke density. If such density levels are not created by a developing fire at the location of detectors, the detectors will not go into alarm.

Smoke detectors, even when working properly, have sensing limitations. Detectors that have photoelectronic sensing chambers tend to detect smoldering fires better than flaming fires, which have little visible smoke. Detectors that have ionizing-type sensing chambers tend to detect fast-flaming fires better than smoldering fires. Because fires develop in different ways and are often unpredictable in their growth, neither type of detector is necessarily best and a given type of detector may not provide adequate warning of a fire.

Smoke detectors cannot be expected to provide adequate warning of fires caused by arson, children playing with matches (especially in bedrooms), smoking in bed, and violent explosions (caused by escaping gas, improper storage of flammable materials, etc.).

While a fire alarm system may lower insurance rates, it is not a substitute for fire insurance!

Heat detectors do not sense particles of combustion and alarm only when heat on their sensors increases at a predetermined rate or reaches a predetermined level. Rate-of-rise heat detectors may be subject to reduced sensitivity over time. For this reason, the rate-of-rise feature of each detector should be tested at least once per year by a qualified fire protection specialist. *Heat detectors are designed to protect property, not life.*

IMPORTANT! Smoke detectors must be installed in the same room as the control panel and in rooms used by the system for the connection of alarm transmission wiring, communications, signaling, and/or power. If detectors are not so located, a developing fire may damage the alarm system, crippling its ability to report a fire.

Audible warning devices such as bells may not alert people if these devices are located on the other side of closed or partly open doors or are located on another floor of a building. Any warning device may fail to alert people with a disability or those who have recently consumed drugs, alcohol or medication. Please note that:

- Strobes can, under certain circumstances, cause seizures in people with conditions such as epilepsy.
- Studies have shown that certain people, even when they hear a fire alarm signal, do not respond or comprehend the meaning of the signal. It is the property owner's responsibility to conduct fire drills and other training exercise to make people aware of fire alarm signals and instruct them on the proper reaction to alarm signals.
- In rare instances, the sounding of a warning device can cause temporary or permanent hearing loss.

A fire alarm system will not operate without any electrical power. If AC power fails, the system will operate from standby batteries only for a specified time and only if the batteries have been properly maintained and replaced regularly.

Equipment used in the system may not be technically compatible with the control. It is essential to use only equipment listed for service with your control panel.

Telephone lines needed to transmit alarm signals from a premise to a central monitoring station may be out of service or temporarily disabled. For added protection against telephone line failure, backup radio transmission systems are recommended.

The most common cause of fire alarm malfunction is inadequate maintenance. To keep the entire fire alarm system in excellent working order, ongoing maintenance is required per the manufacturer's recommendations, and UL and NFPA standards. At a minimum, the requirements of Chapter 7 of NFPA 72 shall be followed. Environments with large amounts of dust, dirt or high air velocity require more frequent maintenance. A maintenance agreement should be arranged through the local manufacturer's representative. Maintenance should be scheduled monthly or as required by National and/or local fire codes and should be performed by authorized professional fire alarm installers only. Adequate written records of all inspections should be kept.

Installation Precautions

WARNING - Several different sources of power can be connected to the fire alarm control panel. Disconnect all sources of power before servicing. Control unit and associated equipment may be damaged by removing and/or inserting cards, modules, or interconnecting cables while the unit is energized. Do not attempt to install, service, or operate this unit until this manual is read and understood.

CAUTION - *System Reacceptance Test after Software Changes.* To ensure proper system operation, this product must be tested in accordance with NFPA 72 Chapter 7 after any programming operation or change in site-specific software. Reacceptance testing is required after any change, addition or deletion of system components, or after any modification, repair or adjustment to system hardware or wiring.

All components, circuits, system operations, or software functions known to be affected by a change must be 100% tested. In addition, to ensure that other operations are not inadvertently affected, at least 10% of initiating devices that are not directly affected by the change, up to a maximum of 50 devices, must also be tested and proper system operation verified.

This system meets NFPA requirements for operation at 0-49° C/32-120° F and at a relative humidity of 85% RH (non-condensing) at 30° C/86° F. However, the useful life of the system's standby batteries and the electronic components may be adversely affected by extreme temperature ranges and humidity. Therefore, it is recommended that this system and all peripherals be installed in an environment with a nominal room temperature of 15-27° C/60-80° F.

Verify that wire sizes are adequate for all initiating and indicating device loops. Most devices cannot tolerate more than a 10% I.R. drop from the specified device voltage.

Adherence to the following will aid in problem-free installation with long-term reliability:

Like all solid state electronic devices, this system may operate erratically or can be damaged when subjected to lightning-induced transients. Although no system is completely immune from lightning transients and interferences, proper grounding will reduce susceptibility. *Overhead or outside aerial wiring is not recommended, due to an increased susceptibility to nearby lightning strikes.* Consult with the Technical Services Department if any problems are anticipated or encountered.

Disconnect AC power and batteries prior to removing or inserting circuit boards. Failure to do so can damage circuits.

Remove all electronic assemblies prior to any drilling, filing, reaming, or punching of the enclosure. When possible, make all cable entries from the sides or rear. Before making modifications, verify that they will not interfere with battery, transformer, and printed circuit board location.

Do not tighten screw terminals more than 9 in-lbs. Over-tightening may damage threads, resulting in reduced terminal contact pressure and difficulty with screw terminal removal.

Though designed to last many years, system components can fail at any time. This system contains static-sensitive components. Always ground yourself with a proper wrist strap before handling any circuits so that static charges are removed from the body. Use static-suppressive packaging to protect electronic assemblies removed from the unit.

Follow the instructions in the installation, operating, and programming manuals. These instructions must be followed to avoid damage to the control panel and associated equipment. FACP operation and reliability depend upon proper installation by authorized personnel.

FCC Warning

WARNING: This equipment generates, uses, and can radiate radio frequency energy and if not installed and used in accordance with the instruction manual, may cause interference to radio communications. It has been tested and found to comply with the limits for class A computing device pursuant to Subpart B of Part 15 of FCC Rules, which is designed to provide reasonable protection against such interference when operated in a commercial environment. Operation of this equipment in a residential area is likely to cause interference, in which case the user will be required to correct the interference at his own expense.

Canadian Requirements

This digital apparatus does not exceed the Class A limits for radiation noise emissions from digital apparatus set out in the Radio Interference Regulations of the Canadian Department of Communications.

Le présent appareil numérique n'émet pas de bruits radioélectriques dépassant les limites applicables aux appareils numériques de la classe A prescrites dans le Règlement sur le brouillage radioélectrique édicté par le ministère des Communications du Canada.

Notes

Table of Contents

CHAPTER 1: Product Description	9
1.1: Product Features	9
1.2: Specifications	11
1.3: Controls and Indicators	12
1.4: Circuits	13
1.5: Components	13
1.6: Optional Modules	14
1.7: Optional Accessories	14
CHAPTER 2: Installation	17
2.1: Mounting Options	17
2.2: Backbox Mounting	17
2.3: Transformer Installation or Replacement	20
2.4: Main Circuit Board Installation or Replacement	21
2.5: Operating Power	22
2.6: Input Circuits	23
2.7: Output Circuits	24
2.8: Power-limited Wiring Requirements	25
2.9: Installation of Optional Modules with Remote Accessories	26
CHAPTER 3: Programming Instructions	30
3.1: Switch Functions	30
3.2: Programmable Features and Options	31
3.3: Entering Program Mode	32
3.4: Programming Function	33
3.4.1: Program Feature Selection	33
3.4.2: Programming Options	33
3.4.3: Programming Example	33
3.5: Program Features and Options	37
3.5.1: Program Features	37
3.5.2: Programming Options	37
3.6: Default Programming Mode	42
CHAPTER 4: Operating Instructions.....	43
4.1: Switch Functions in Normal Mode	43
4.2: Status LEDs	44
4.3: Operation	45
4.3.1: Fire Alarm Response	46
4.3.2: Fire Alarm Restoral	46
4.3.3: System Supervisory Condition Response	46
4.3.4: System Supervisory Restoral Response	47
4.3.5: Trouble Condition Response	47
4.3.6: Trouble Condition Restoral	47
CHAPTER 5: Servicing.....	48
5.1: Walktest Mode	48
5.2: Last Event/History Mode	49
5.3: Lamp Test	50
CHAPTER 6: Power Supply Calculations.....	51
6.1: Overview	51
6.2: Calculating the AC Branch Circuit	51
6.3: Calculating the System Current Draw	52

Table of Contents

6.3.1: Overview52
6.3.2: How to Use Table 6-3 on page 55 to Calculate System Current Draw52
6.4: Calculating the Battery Size54
6.4.1: NFPA Battery Requirements54
6.4.2: Selecting and Locating Batteries54
Appendix A: NFPA Requirements55
Appendix B: Wire Requirements56
Appendix C: Slide-in Labels57

This control panel has been designed to comply with standards set forth by the following regulatory agencies:



NFPA Standards

This Fire Alarm Control Panel complies with the following NFPA Standards:

NFPA 72 National Fire Alarm Code for Local Fire Alarm Systems (Automatic, Manual, Waterflow and Sprinkler Supervisory), Auxiliary Fire Alarm Systems (Automatic, Manual and Waterflow), Remote Station Fire Alarm Systems (Automatic, Manual and Waterflow) and Proprietary Fire Alarm Systems (Automatic, Manual and Waterflow).



Underwriters Laboratories Documents:

- UL 38 Manually Actuated Signaling Boxes
- UL 217 Smoke Detectors, Single and Multiple Station
- UL 228 Door Closers - Holders for Fire Protective Signaling Systems
- UL 268 Smoke Detectors for Fire Protective Signaling Systems
- UL 268A Smoke Detectors for Duct Applications
- UL 346 Waterflow Indicators for Fire Protective Signaling Systems
- UL 464 Audible Signaling Appliances
- UL 521 Heat Detectors for Fire Protective Signaling Systems
- UL 864 Standard for Control Units for Fire Protective Signaling Systems
- UL 1481 Power Supplies for Fire Protective Signaling Systems
- UL 1638 Visual Signaling Appliances
- UL 1971 Signaling Devices for Hearing Impaired

Other:

- NEC Article 250 Grounding
- NEC Article 300 Wiring Methods
- NEC Article 760 Fire Protective Signaling Systems
- Applicable Local and State Building Codes
- Requirements of the Local Authority Having Jurisdiction (LAHJ)

Fire•Lite Documents

- Fire•Lite Device Compatibility Document Document #15384
- FCPS-24F(E) Field Charger/Power Supply Document #50079
- LED-10 Annunciator Document #50361
- ACM-8RF Annunciator Control Relay Module Document #50362
- 411 Digital Alarm Communicator/Transmitter Document #50921
- 411UD Digital Alarm Communicator/Transmitter Document #50759

MS-2410B Main Circuit Board

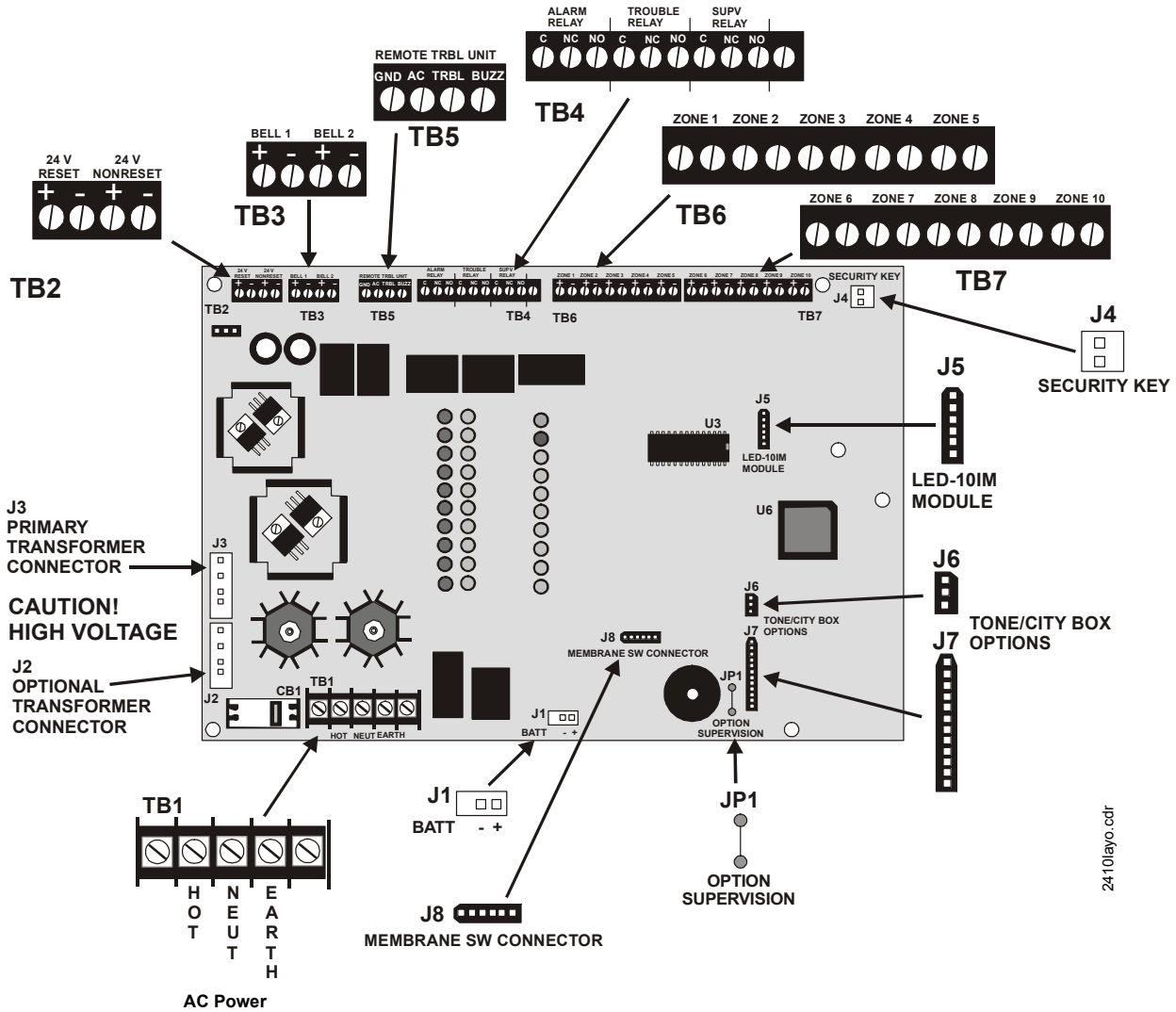

MS-2410B Terminals and Connectors

2410layo.cdr

CHAPTER 1 *Product Description*

The MS-2410B is a 10-zone FACP (Fire Alarm Control Panel), which uses conventional input devices. The panel accepts waterflow devices, two-wire smoke detectors, four-wire smoke detectors, pull stations and other normally-open contact devices. Outputs include two Notification Appliance Circuits (NACs), three standard Form-C relays (alarm, trouble and supervisory) and an EIA-485 port to interface with remote annunciators and optional remote relay modules. The FACP is field programmable via the panel keypad. It also supervises all wiring, AC voltage and battery level. The MS-2410BE offers the same features as the MS-2410B but allows connection to 220/240 VAC input.

1.1 Product Features

- 10 Class B Initiating Device Circuits (IDCs)
 - ✓ All zones accept smoke detectors and any normally open contact device
 - ✓ Zones 1 - 8 configured as general alarm zones
 - ✓ Zones 9 - 10 can be configured as smoke zones or supervisory alarm zones
- Two Class B Notification Appliance Circuits (NACs)
- Form-C Alarm Relay
- Form-C Trouble Relay
- Form-C Supervisory Relay
- 3.6 amps of system power expandable to 6.6 amps
- RTB Remote Trouble Buzzer
- Remote Relay Option Module (ACM-8RF) providing one 5.0 amp relay per zone
- Dress Panel coverplate (DP-2410B)
- Built-in keypad for panel control and programming
- 24 volt operation
- Trouble Reminder
- Alarm Verification (zones 1 through 3 only)
- Interfaces with Fire•Lite annunciators (requires LED-10IM Option Module)
 - ✓ LED-10 Series Remote Annunciators provide red alarm and yellow trouble LEDs
- Small backbox size 16.9" (42.9 cm) X 14.5" (36.8 cm) X 4.5" (11.43 cm)
- Silence Inhibit Notification Appliance Circuits
- Auto-Silence Notification Appliance Circuits
- Fuseless design
- Low AC voltage sense
- Silent or audible Walktest

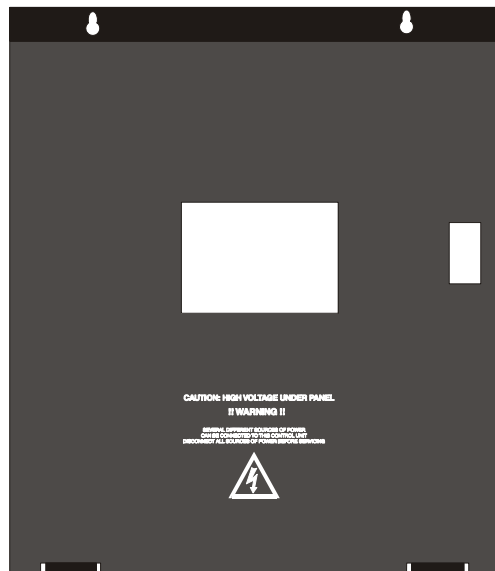

FIGURE 1-1: DP-2410B

Note: Unless otherwise specified, the term MS-2410B shall be used in this manual to refer to both the MS-2410B and the MS-2410BE Fire Alarm Control Panels.

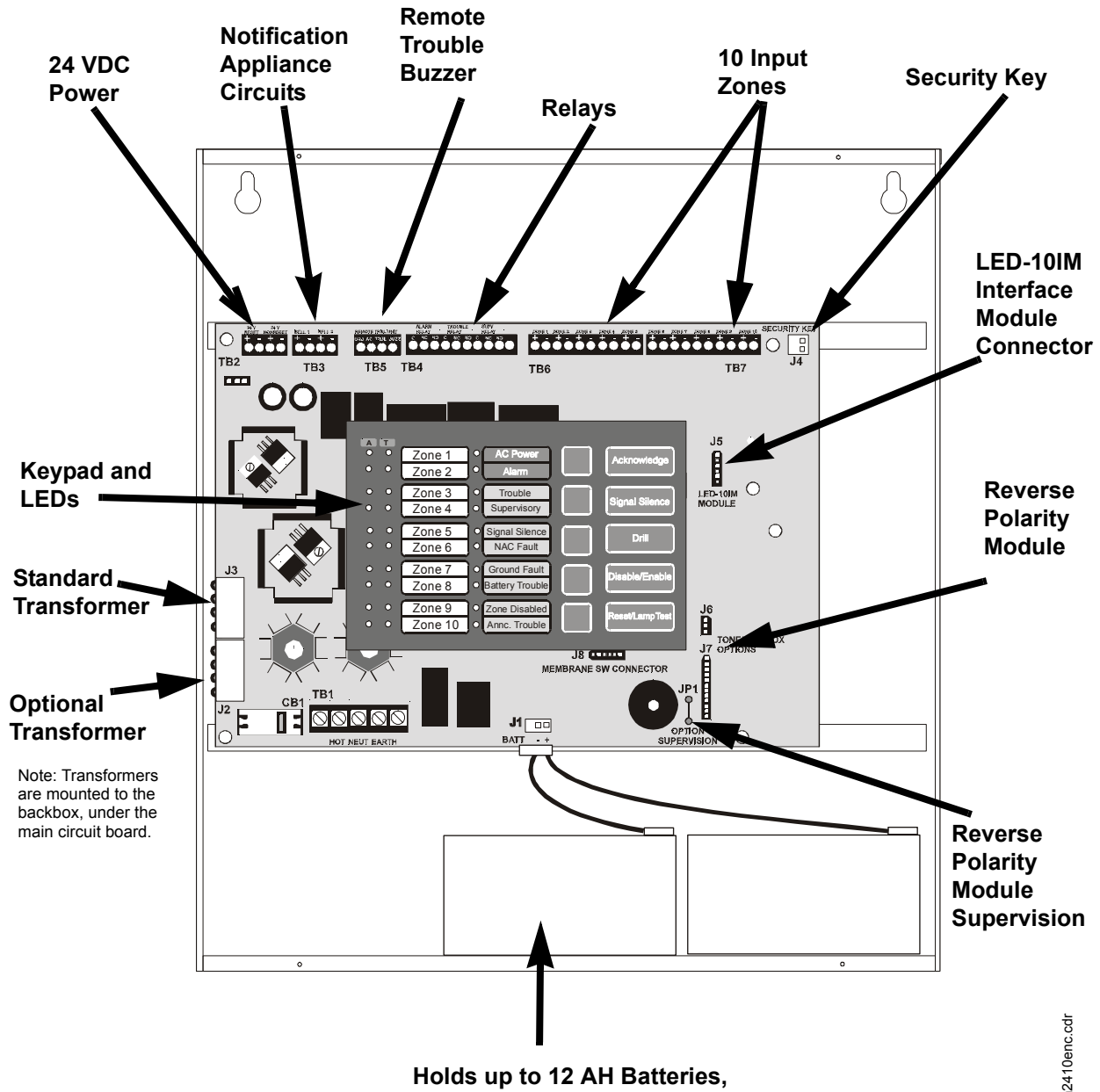

FIGURE 1-2: MS-2410B Panel

m2410enc.cdr

1.2 Specifications

AC Power - TB1

MS-2410B: 120 VAC, 60 Hz, 2.3 amps

MS-2410BE: 220/240 VAC, 50 Hz, 1.15 amps

Wire size: minimum #14 AWG (2.0 mm²) with 600V insulation

Battery (lead acid only) - J1

Maximum Charging Circuit: Normal Flat Charge—27.6V @ 0.8 amp

Maximum Charger Capacity: 18 Amp Hour battery (MS-2410B cabinet holds maximum 12 Amp Hour battery. Larger batteries require Fire•Lite BB-17F)

Initiating Device Circuits TB6 and TB7

General Alarm Zones 1 through 8

Smoke Zones or Supervisory Alarm Zones 9 and 10

Operation: All zones Class B

Normal Operating Voltage: Nominal 24 VDC (ripple = 100 mV maximum)

Alarm Current: 15 mA threshold

Short Circuit Current: 42 mA maximum

Maximum Loop Resistance: 100 ohms

End-of-Line Resistor: 4.7K, ½ watt (Part #27072)

Standby Current: 7.26 mA (includes ELR and 2 mA maximum detector current)

Smoke Detector Identifier A

Refer to Fire•Lite Device Compatibility Document for listed compatible devices.

Notification Appliance Circuits - TB3

Class B wiring

Operating voltage nominal 24 volts

Current for all external devices: 3.0 amps expandable to 6.0 amps ¹

Current Limit: TB3 via PTC

Maximum signaling current/circuit: TB3 = 1.25 amps expandable to 2.5 amps

End-of-Line resistor: 4.7K, ½ watt (Part #71252) for Notification Appliance Circuits

Refer to Fire•Lite Device Compatibility Document for listed compatible devices

Three Form-C Relays - TB4

TB4 relay contact rating: 2.0 amps @ 30 VDC (resistive), 2.0 amps @ 30 VAC (resistive)

Four-wire Smoke Detector Power - TB2 Terminals 3(-) & 4(+)

Maximum ripple voltage: 10 mV_{RMS} Operating Voltage nominal 24 volts

Up to 300 mA is available for powering 4-wire smoke detectors ¹

Recommended maximum Standby current is 50 mA²

Refer to Fire•Lite Device Compatibility Document for compatible listed device

-
1. Total current for nonresettable power, four-wire smoke power, and two Notification Appliance Circuits *must not exceed 6.0 amps*. Total system current in excess of 3.6 amps requires the XRM-24 Transformer (XRM-24E for 220/240 VAC applications) and 12 Amp Hour or 18 Amp Hour batteries.
 2. For power supply and battery calculations, refer to “Power Supply Calculations” on page 51.

Nonresettable 24 VDC Power - TB2 Terminals 1(-) & 2(+)

Maximum ripple voltage: 10 mV_{RMS} Operating Voltage nominal 24 volts
 Total DC current available from this output is up to 500 mA ¹
 Recommended maximum Standby current is 150 mA
 Refer to Fire•Lite Device Compatibility Chart for compatible listed devices

Remote Trouble Buzzer - TB5

Operating Voltage: nominal 24 VDC
 DC current when RTB Remote Trouble Buzzer is in normal standby (AC Power LED on alone) is 20 mA.
 Maximum DC current from this output when RTB Remote Trouble Buzzer is active is 50 mA.

1.3 Controls and Indicators

Front Panel Membrane Keys in Normal Mode

- Acknowledge
- Signal Silence
- Drill
- Disable/Enable
- Reset/Lamp Test

Note that programming keys function slide-in-labels and option/feature slide-in labels are also provided and should be inserted while in Program Mode to view the altered key functions. Refer to Figure 4-1, "LED Indicators and Keypad," on page 43 and "Slide-in Labels" on page 57.

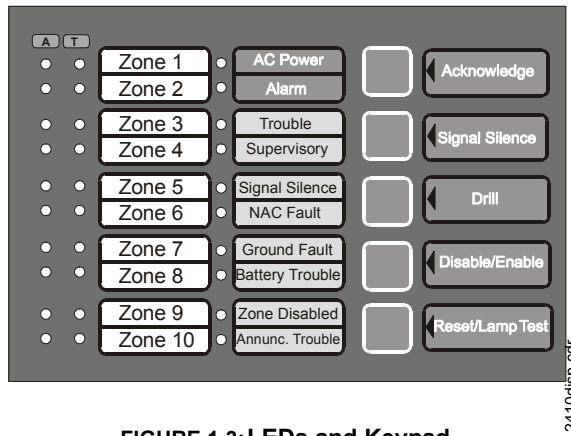

FIGURE 1-3: LEDs and Keypad

LEDs

- AC Power - green LED
- Alarm - red LED
- Trouble - yellow LED
- Supervisory - yellow LED
- Signal Silence - yellow LED
- NAC Fault - yellow LED
- Ground Fault - yellow LED
- Battery Trouble - yellow LED
- Zone Disabled - yellow LED
- Annunciator Trouble - yellow LED
- Zone Fire Alarm - Zones 1 through 10 - red LEDs
- Zone Supervisory Alarm - Zones 9 and 10 only - red LEDs
- Zone Trouble - Zones 1 through 10 - yellow LEDs

Note: A blank slide-in label is provided for circuits 1 through 10 which may be customized by the customer. In addition, slide-in-labels listing the programming features/options and programming key functions are provided and should be inserted while in Program Mode.

1. Total current for nonresettable power, four-wire smoke power, and two Notification Appliance Circuits *must not exceed 6.0 amps*. Total system current in excess of 3.6 amps requires the XRM-24 Transformer (XRM-24E for 220/240 VAC applications) and 12 Amp Hour or 18 Amp Hour batteries.

Circuits

Local Sounder

A piezo sounder provides separate and distinct sounds for alarm, trouble and supervisory conditions:

- Alarm - on steady
- Alarm Verification - pulse 1 second On and 1 second Off
- Trouble - pulse 1 second On and 1 second Off
- Supervisory - pulse ½ second On and ½ second OFF

1.4 Circuits

Input Circuits

Ten input circuits provide Class B configuration. Input circuits 1 through 10 may be used as standard fire alarm control panel zones and circuits 9 and 10 may be used as supervisory alarm zones. All ten Initiating Device Circuits accept normally-open contact devices and two-wire smoke detectors.

Output Circuits

- 24 Volt Resettable Power Output 300 mA
- 24 Volt Nonresettable Power Output 500 mA
- 24 Volt Remote Trouble Buzzer Output 50 mA maximum
- 24 Volt Battery Charger (up to 18 AH batteries)
- EIA-485 Port (interfaces to LED-10 Series Annunciators and ACM-8RF Remote Relay Module)

Notification Appliance Circuits

Two Notification Appliance Circuits Class B.

Relays

Three dry Form-C relays for system alarm, system trouble and supervisory are provided standard. Contacts are rated 2.0 amps @ 30 VDC (resistive) and 2.0 amps @ 30 VAC (resistive).

EIA-485 Port (Requires LED-10IM Module)

EIA-485 compatible port on the LED-10IM option module supports up to 10 different device addresses which can consist of LED-10 Series Remote Annunciators or ACM-8RF Relay Modules or any combination of the two modules.

Battery Charger

Battery Charger will charge up to 18 AH batteries. The MS-2410B cabinet holds a maximum of 12 AH batteries. The Fire•Lite BB-17F is required to hold 18 AH batteries. The charger is rated for 800 mA maximum current.

1.5 Components

Main Circuit Board

The main circuit board contains the system's CPU, power supply, other primary components and wiring interface connectors. Optional modules plug in and are mounted to the main circuit board. The main circuit board is delivered premounted in the cabinet.

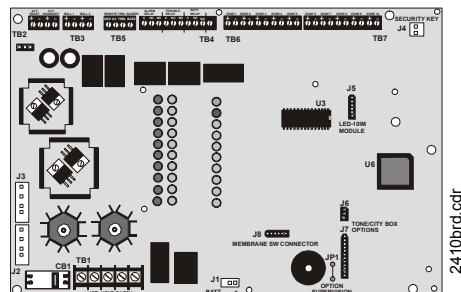

FIGURE 1-4: Main Circuit Board

Optional Modules

Cabinet

The cabinet is red and the backbox measures 16.90” (42.9 cm) long X 14.50” (36.8 cm) high X 4.5” (11.43 cm) deep and provides space for two batteries (up to 12 Amp Hours). Also available is an optional dress panel, DP-2410B, which mounts inside the cabinet.



FIGURE 1-5: MS-2410B Cabinet

Transformer Assembly

One 100VA transformer is provided standard with the panel. An optional 100VA transformer XRM-24 (XRM-24E for 220/240 VAC applications) is available to provide maximum accessory power.

Batteries

The cabinet provides space for 12 Amp Hour batteries (larger batteries up to 18 Amp Hour batteries, use the listed Fire•Lite BB-17F battery box). Batteries must be ordered separately.

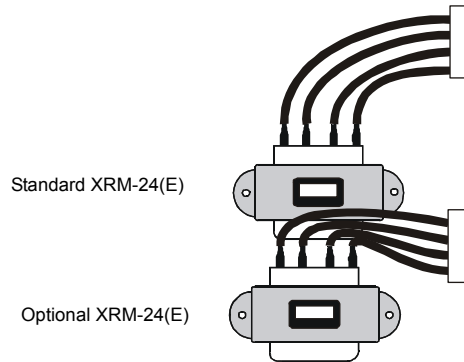

FIGURE 1-6: Transformer Assemblies

1.6 Optional Modules

LED-10IM

The LED-10IM Interface Module provides an EIA-485 port to support the LED-10 Series Remote Annunciator and ACM-8RF Relay Modules. EIA-485 wiring is supervised for short, open and grounded circuits by this module. The LED-10IM mounts to connector J5 on the main circuit board.

4XTMF Transmitter Module

The 4XTMF provides a supervised output for local energy municipal box transmitter and alarm and trouble reverse polarity. It includes a disable switch and disable trouble LED. A module jumper option allows the reverse polarity circuit to open with a system trouble condition if no alarm condition exists.

1.7 Optional Accessories

Dress Panel

A dress panel (DP-2410B) is available as an option. The dress panel restricts access to the system wiring while allowing access to the membrane switch panel. Refer to Figure 1-1, “DP-2410B,” on page 9.

Optional Accessories

Battery Box

The Fire•Lite BB-17F battery box may be used to house two batteries greater than 12 Amp Hour to a maximum of 18 Amp Hour. The battery box mounts directly below the MS-2410B cabinet, centered to the main circuit board. The BB-17F is red and is provided with knockouts.

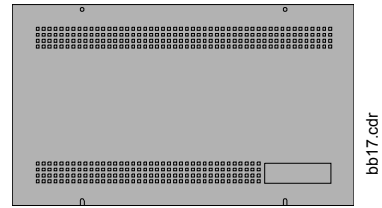

FIGURE 1-7: BB-17F Battery Box

Remote Trouble Buzzer

One Remote Trouble Buzzer can be connected to the MS-2410B control panel using four wires. The remote unit includes an AC LED, System Trouble LED and piezo sounder which are controlled by the MS-2410B. It mounts to a single-gang electrical box.

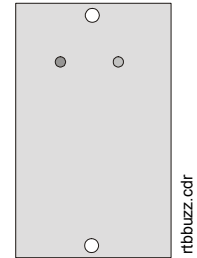

FIGURE 1-8: RTB Remote Trouble Buzzer

ACM-8RF Relay Module

The ACM-8RF option module provides eight Form-C relays rated at 5.0 amps each. The Relay Module connects to the EIA-485 port off of the LED-10IM option module. Relays are assigned to each of the 10 Initiating Device Circuits.

411 and 411UD Digital Alarm Communicator/Transmitter

The three input/channel 411 and the four input/channel 411UD are dual line, digital alarm communicator transmitters which can be used as slave communicators with the MS-2410B. The inputs/channels are compatible with normally open relay contacts, require End-Of-Line (EOL) resistors, are supervised and are fully programmable. The communicators interface with the public switched telephone network and are compatible with most central station receivers. Power supplied must be 12 or 24 volts, filtered and nonresettable. The communicators are mounted in a small metal enclosure, providing a variety of mounting options. Refer to the 411 or 411UD manual for detailed information on installation, wiring and programming.

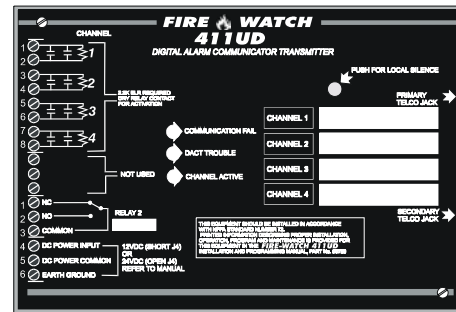

FIGURE 1-9: 411UD Communicator

LED-10 Series Annunciator (LED Zone Type Annunciator)

The LED-10 Series is a 10 zone LED annunciator which mounts on a 3-gang electrical box and provides LED indication of the following:

- Alarm Zones 1 through 10
- Supervisory Zones 9 and 10 (LED-10LS2 only)
- Trouble Zones 1 through 10
- AC Power (green)
- System Alarm (red)
- System Trouble (yellow)
- System Supervisory (yellow)
- Alarm Silence (yellow)

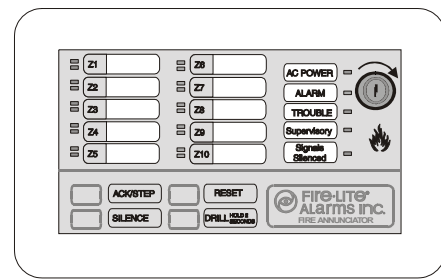

FIGURE 1-10: LED-10 Series Annunciator

A local trouble sounder is standard and switches for remote Acknowledge, Silence, Drill and Reset are also provided on the LED-10 only. Wiring is inherently supervised by the FACP. Slide-in paper labels permit an easy change of zone information. DIP switches allow the enabling and disabling of the local piezo sounder (with approval of local AHJ), enabling and disabling of the mechanical keyswitch which may be used to prevent unauthorized use of the function switches and selection of annunciator receive/transmit mode.

Note that the LED-10 Series Remote Annunciators require the use of the LED-10IM Interface Module.

FCPS-24F(E) Remote Power Supply (System Power Expansion)

The FCPS-24F(E) is a compact, remote power supply and battery charger. This remote power supply consists of a filtered 24 VDC output that may be configured to drive up to four Notification Appliance Circuits (four Class B or two Class A and two Class B). Alternately, the four Notification Appliance Circuits may be used as auxiliary power configured for resettable or nonresettable operation.

The FCPS-24F(E) may be used in a number of different applications. It may be used as a remotely mounted power supply and battery charger powering up to four, coded or noncoded, Notification Appliance Circuits. Alternately, any or all of these circuits may be used as 24 VDC output circuits capable of powering four-wire smoke detectors or any device that requires filtered power. These circuits may be configured as resettable or non-resettable outputs to expand FACP auxiliary system power.

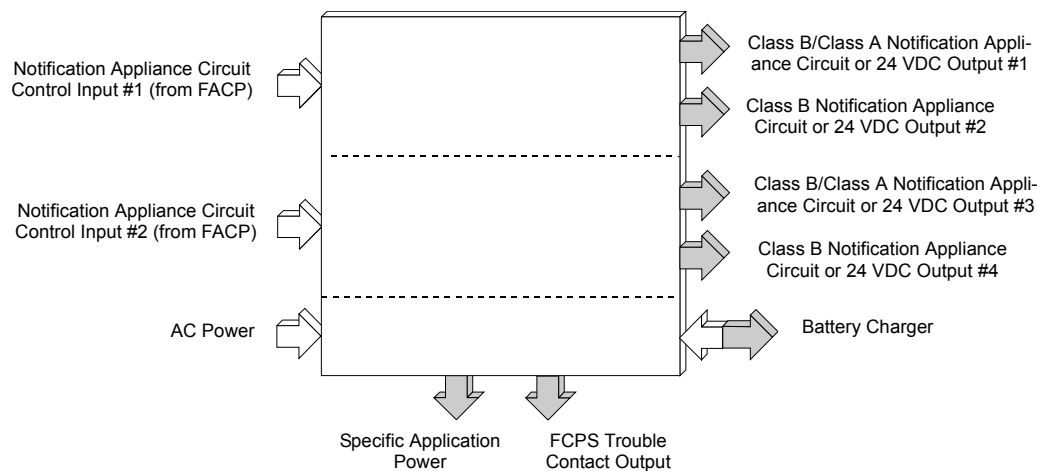

FIGURE 1-11:FCPS-24F(E)

One of the most common applications for the FCPS-24F(E) remote power supply utilizes the NAC expander mode. In this application, one or two Notification Appliance Circuits (NACs) are connected from the main FACP NAC output(s) to the remote power supply Control Input circuits. When these Control Input circuits activate (due to reverse polarity of the NAC output), the power supply will activate its corresponding outputs. NAC Control Input #1 controls power supply output circuits #1 and #2. NAC Control Input #2 controls output circuits #3 and #4.

During the inactive state, the remote power supply supervises its NAC field wiring for short and open circuits. If a fault is detected, the supply will enter a trouble condition and illuminate the corresponding NAC trouble LED (Output Circuits 1-4), however, once the Notification Appliance Circuits are activated, the supervision is disabled and the circuits are no longer supervised. Supervision of other power supply faults such as low battery, Earth Fault, AC loss and battery charger failure will continue and may be monitored via the independent trouble relay contact.

If a specific application requires that all four outputs activate at the same time, only one NAC control input from the FACP is necessary. For this application, The Notification Appliance Circuit from the FACP is wired into NAC Control Input #1 of the remote supply and then a pair of wires are connected from NAC Control Output #1 to NAC Control Input #2. Refer to the FCPS-24F(E) Installation, Operation and Application Manual for a complete description and examples of applications.

CHAPTER 2 *Installation*

2.1 Mounting Options

The cabinet may be either semi-flush or surface mounted. The door is removable during the installation period by opening and lifting off the hinges. The cabinet mounts using two key slots and two additional 0.250" (6.35 mm) diameter holes located in the backbox. The key slots are located at the top of the backbox and the two securing holes at the bottom.

Carefully unpack the system and check for shipping damage. Mount the cabinet in a clean, dry, vibration-free area where extreme temperatures are not encountered. The area should be readily accessible with sufficient room to easily install and maintain the panel. Locate the top of the cabinet approximately five feet above the floor with the hinge mounting on the left. Determine the number of conductors required for the devices to be installed. Sufficient knockouts are provided for wiring convenience. Select the appropriate knockout(s) and pull the required conductors into the box. All wiring should be in accordance with the National and/or Local codes for fire alarm systems.



FIGURE 2-1: MS-2410B Mounting

2.2 Backbox Mounting

- ✓ Open the door and lift the door off the pin hinges.
- ✓ Remove the main PC board assembly and transformer(s) to prevent damage during installation (refer to “Transformer Installation or Replacement” on page 20 and “Main Circuit Board Installation or Replacement” on page 21). Set the board and transformer aside in a safe, clean place. Avoid static discharge which may damage the board.
- ✓ Mark and predrill holes for the top two keyhole mounting bolts using the dimensions illustrated.
- ✓ Install two upper fasteners in the wall with the screw heads protruding.
- ✓ Using the upper 'keyholes', mount the backbox over the two screws.
- ✓ Mark and drill the lower two holes.
- ✓ Mount backbox, install remaining fasteners and tighten.
- ✓ When the location is dry and free of construction dust, install the transformer(s) and main circuit board as described in the following sections.

Backbox Mounting

Draw wires through the respective knockout locations.

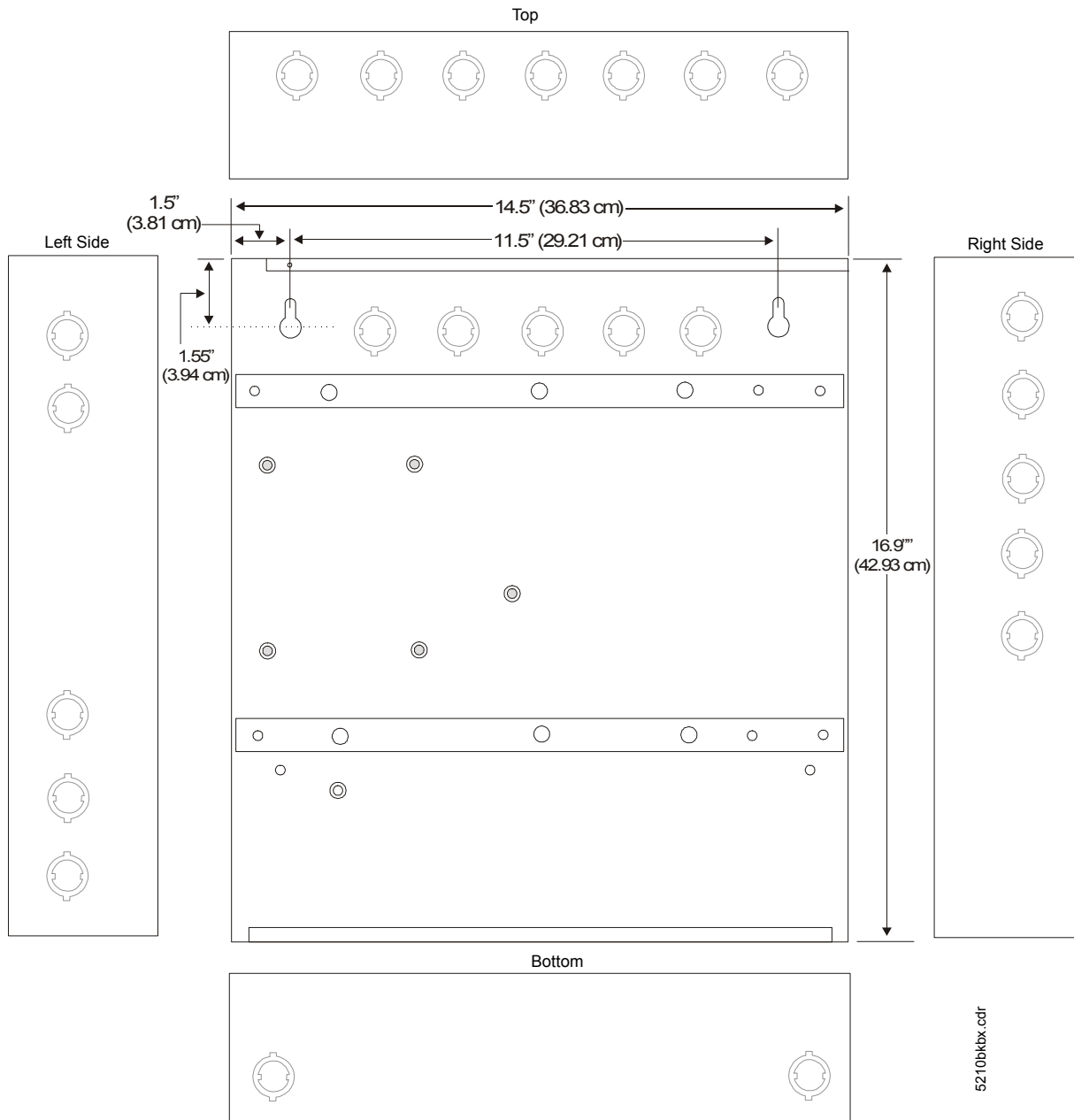
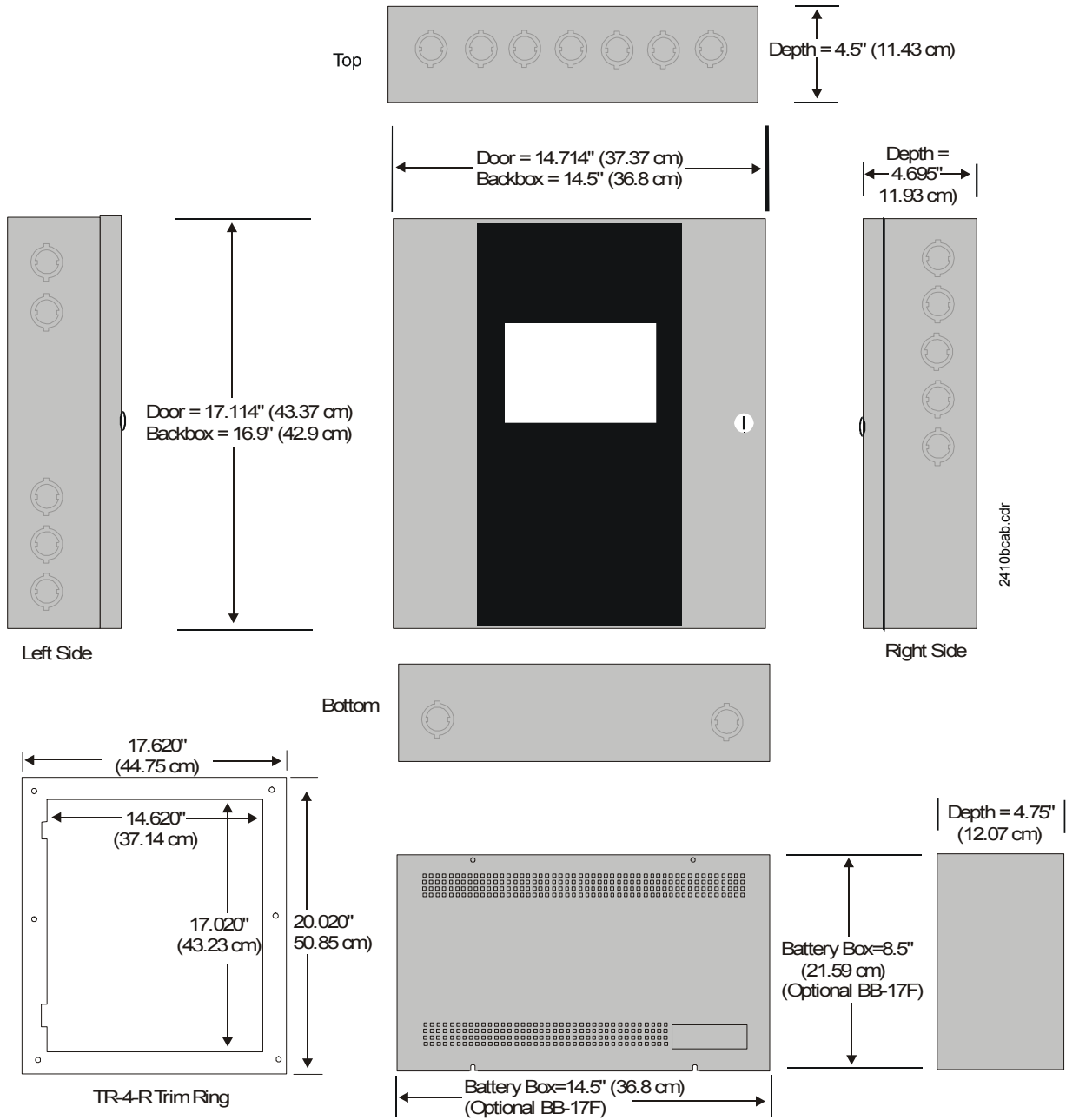

FIGURE 2-2: Cabinet Dimensions and Knockout Locations

Backbox Mounting



When batteries larger than 12 Amp Hour are being used, the BB-17F battery box (or equivalent) must be installed. To install the BB-17F:

1. Mount the FACP cabinet to the wall.
2. Remove knockouts on the bottom of the FACP cabinet and top of the BB-17F.
3. Using conduit, hang the BB-17F from the FACP cabinet making sure there is at least ½" of clearance between the two cabinets.
4. Anchor the BB-17F to the wall.

FIGURE 2-3: FACP Backbox

2.3 Transformer Installation or Replacement

One 100 VA transformer P/N: XRM-24 (XRM-24E for 220/240 VAC applications) is supplied standard with the FACP. An optional second XRM-24(E) transformer can be ordered and installed to supply additional system power. To install the transformer(s):

- ✓ Position the supplied transformer over the top set of mounting studs as illustrated below
- ✓ Secure to the studs with the supplied nuts
- ✓ If a second optional transformer has been ordered, position it over the bottom set of mounting studs as illustrated below
- ✓ Secure the optional transformer with the supplied nuts
- ✓ Before installing the main circuit board, be sure to plug the transformer connector into J3 Primary Transformer Connector on the main circuit board, and the optional transformer connector into J2 Optional Transformer Connector on the main circuit board.

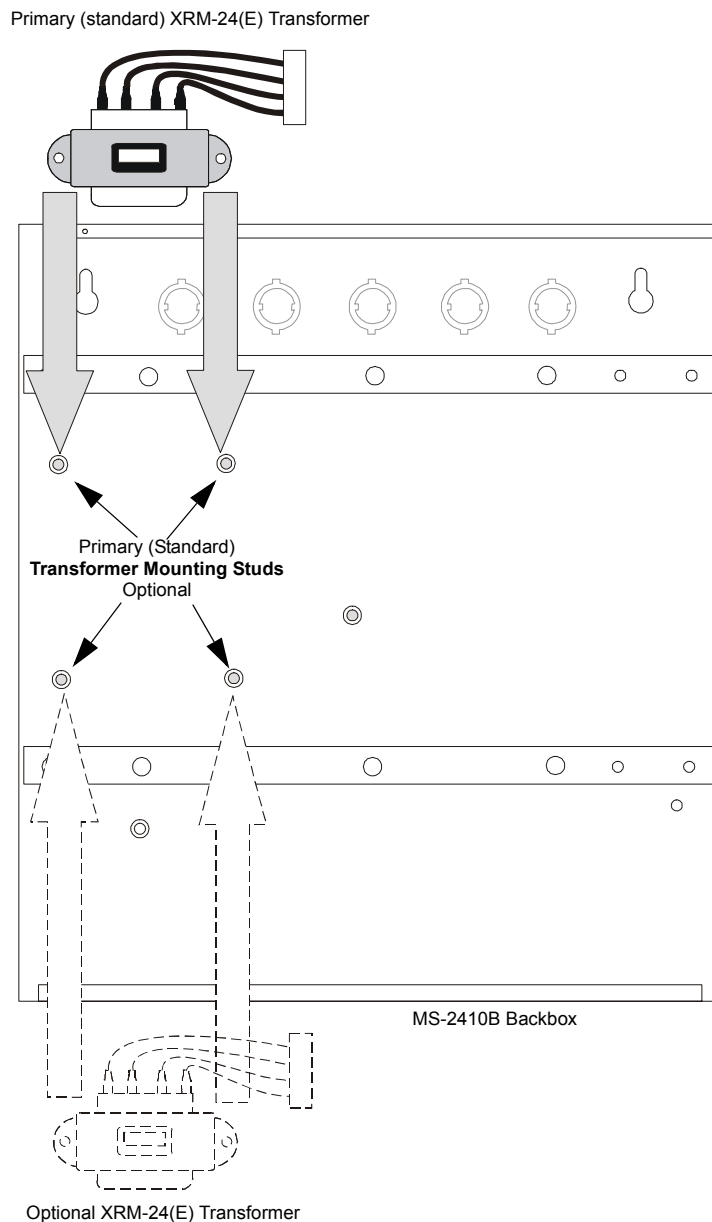

FIGURE 2-4: Transformer Installation

2.4 Main Circuit Board Installation or Replacement



The circuit board contains static-sensitive components. Always ground yourself with a proper wrist strap before handling any boards so that static charges are removed from the body. Use static suppressive packaging to protect electronic assemblies.

1. Position the main circuit board near the installed transformer(s) and plug the transformer connector(s) into J3 (Primary) and J2 (Optional) located on the main circuit board
2. Position the main circuit board over the installed standoffs on the backbox rails as illustrated below
3. Secure the main circuit board to the standoffs with the supplied screws

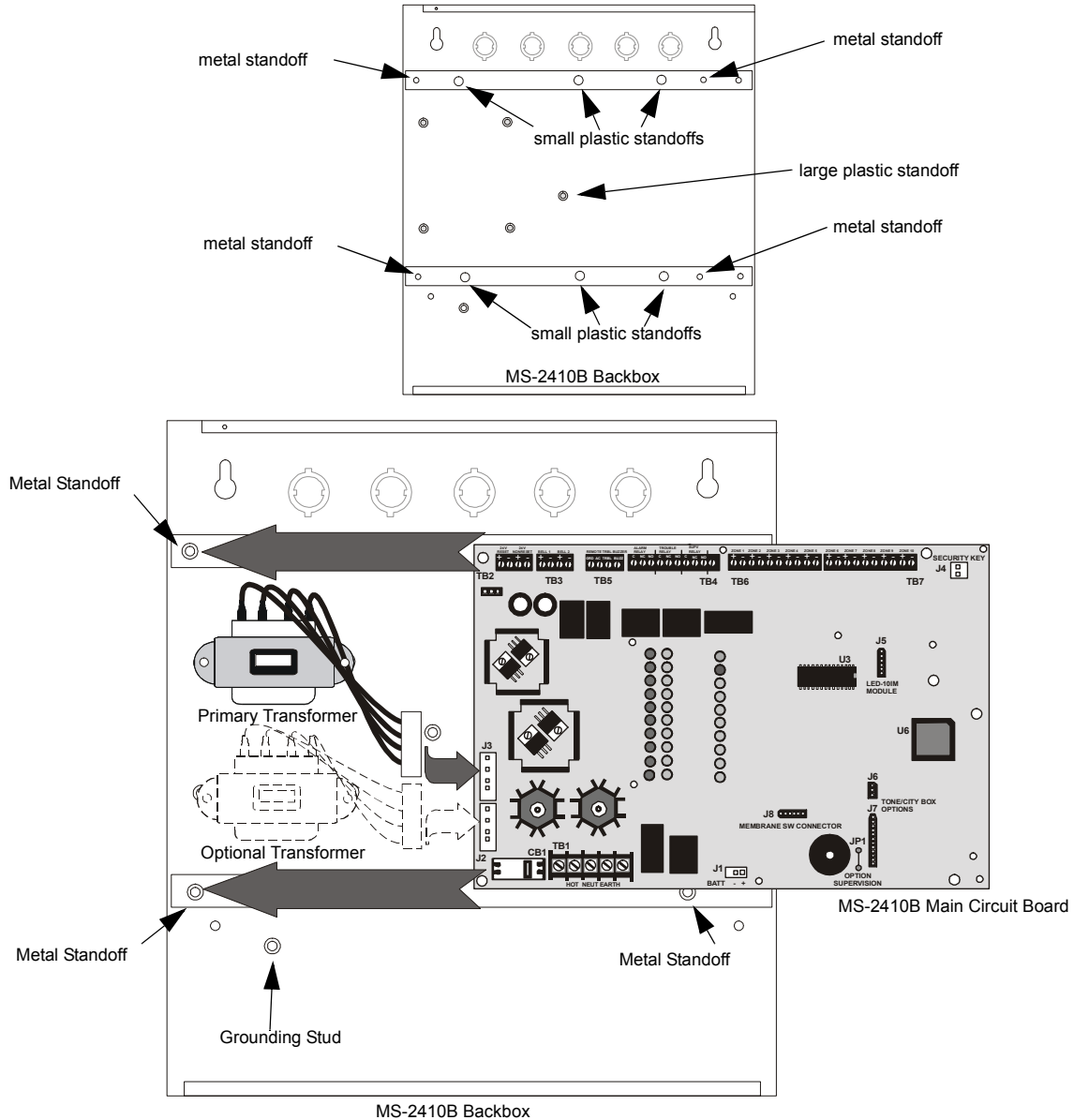

FIGURE 2-5: Main Circuit Board Installation

2.5 Operating Power

WARNING: Several different sources of power can be connected to this panel. Disconnect all sources of power before servicing. The panel and associated equipment may be damaged by removing and/or inserting cards, modules or interconnecting cables while this unit is energized.

Primary Power Source (AC) and Earth Ground Connections

AC power connections are made inside the control panel cabinet. The primary power source for the MS-2410B is 120 VAC, 60 Hz, 2.3 amps and the MS-2410BE is 220/240 VAC, 50 HZ, 1.15 amps. Run a pair of wires (with ground conductor) from the protected premises main breaker box to TB1 of the main circuit board. As per the National Electrical Code, use 14 AWG (2.00 mm², 1.6 mm O.D.) or heavier gauge wire with 600V insulation. No other equipment may be connected to this circuit. In addition, this circuit must be provided with overcurrent protection and may not contain any power disconnect devices. A separate Earth Ground connection must be made to ensure proper panel operation and lightning and transient protection. Connect the Earth Ground wire [minimum 14 AWG (2.00 mm²)] to the mounting stud located on the cabinet near TB1. Do not use conduit for the Earth Ground connection since this does not provide reliable protection.

Secondary Power Source (Batteries)

Observe polarity when connecting the battery. Connect the battery cable to J1 on the main circuit board using the plug-in connector and cable provided. The battery charger is current-limited and capable of recharging sealed lead acid type batteries. The charger shuts off when the system is in alarm. See “Wire Requirements” on page 56 for calculation of the correct battery rating.

WARNING: Battery contains sulfuric acid which can cause severe burns to the skin and eyes and can destroy fabrics. If contact is made with sulfuric acid, immediately flush the skin or eyes with water for 15 minutes and seek immediate medical attention.

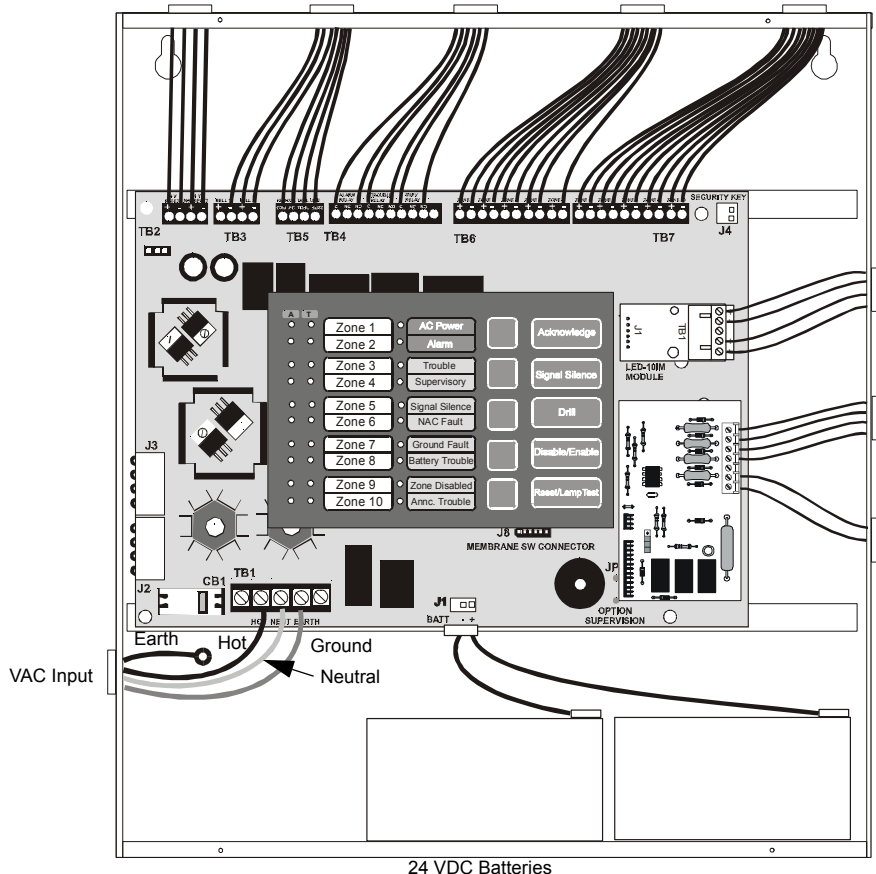

FIGURE 2-6: Operating Power Connections

2.6 Input Circuits

The control panel has 10 zone input circuits. The maximum loop resistance limit for each input circuit is 100 ohms. All field wiring of each zone is supervised for opens and ground faults. Both conditions are visually and audibly annunciated.

Each zone is a Class B Initiating Device Circuit (IDC) designed to accept any normally-open contact devices and conventional 2-wire, 24 volt smoke detectors.

All zones may be configured for general fire alarm applications. In addition, zones 9 and 10 can be configured as fire alarm zones or supervisory alarm zones.

Four-wire smoke detectors may be connected to any zone. Resettable power is provided via TB2 Terminals 3 and 4. Refer to the Fire•Lite Device Compatibility Document for a list of compatible smoke detectors.

It is allowable to mix an assortment of device types (i.e. smoke detectors, heat detectors, pull stations, etc.) on any zone. If, however, alarm verification is employed on zones 1, 2 and 3, only smoke detectors should be installed on these three zones.

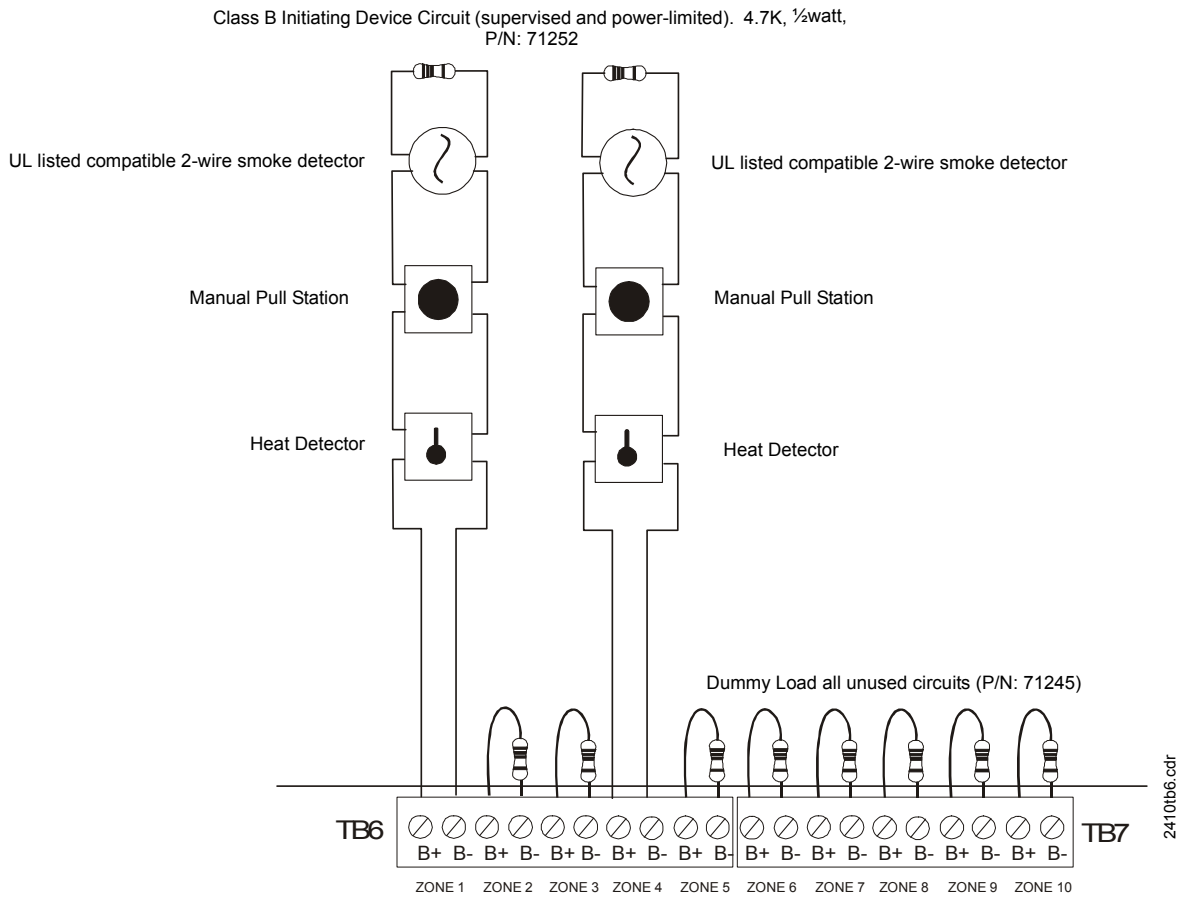

FIGURE 2-7: Class B Initiating Device Circuit Connections

2.7 Output Circuits

DC Power Output Connections

4-Wire Smoke Detector Power (300 mA) 24 VDC filtered, resettable power for 4-wire smoke detectors can be obtained from TB2 Terminals 3(-) and 4(+)

Nonresettable Power (500 mA) 24 VDC filtered, nonresettable power can be obtained from TB2 Terminals 1(-) and 2(+).

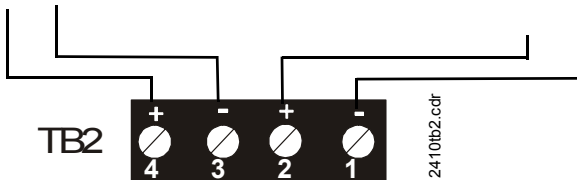

FIGURE 2-8: Auxiliary Power Connections

Notification Appliance Circuits

The MS-2410B provides two Notification Appliance Circuits standard as Class B. Each circuit is capable of a maximum of 2.5 amps of current. Total current drawn from these as well as other DC power outputs cannot exceed 3.6 amps with the standard transformer, 6.6 amps if an optional XRM-24(E) Transformer is installed. Circuits are supervised. Refer to the Fire•Lite Device Compatibility Document for a listing of compatible notification appliances.

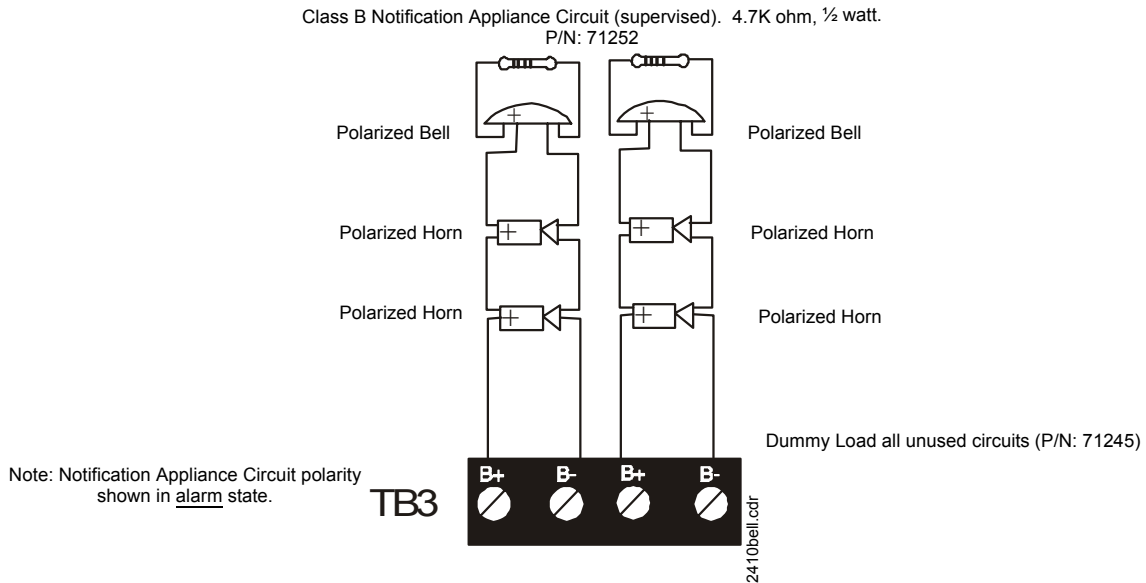

FIGURE 2-9: Notification Appliance Circuit Connections

Power-limited Wiring Requirements

Standard Relays

The control panel provides three Form-C relays rated for 2.0 amps @ 30 VDC (resistive) and 2.0 amps @ 30 VAC (resistive).

Relay connections may be power-limited or nonpower-limited, provided that a minimum of 0.25" is maintained between conductors of power-limited and nonpower-limited circuits.

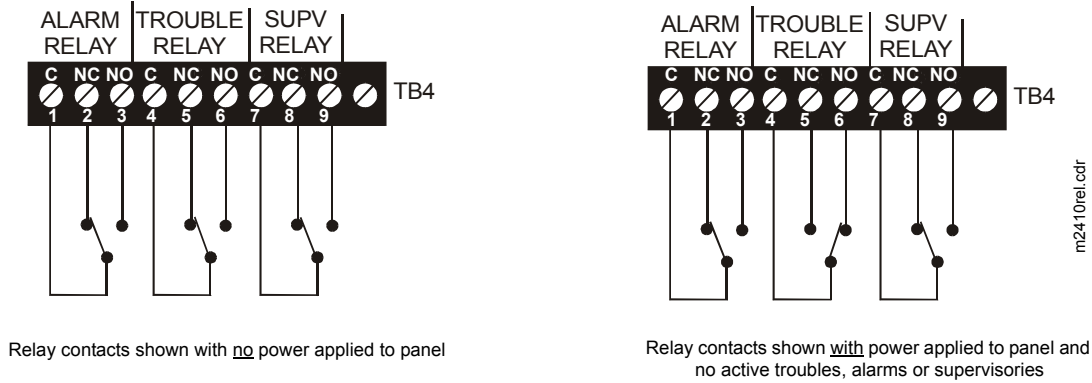

FIGURE 2-10: Relay Terminals

2.8 Power-limited Wiring Requirements

Power-limited and nonpower-limited circuit wiring must remain separated in the cabinet. All power-limited circuit wiring must remain at least 0.25" (6.35 mm) away from any nonpower-limited circuit wiring. Furthermore, all power-limited and nonpower-limited circuit wiring must enter and exit the cabinet through different knockouts and/or conduits. A typical wiring diagram for the MS-2410B is illustrated in Figure 2-11.

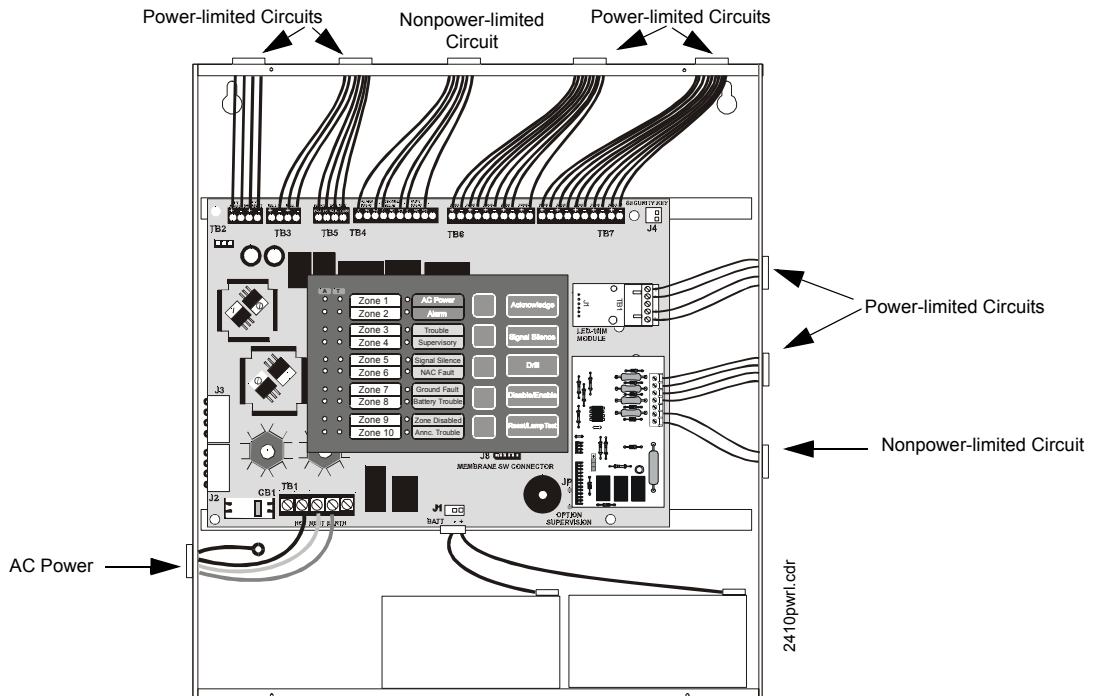

FIGURE 2-11: Typical Wiring Diagram for Power-limited Requirements

2.9 Installation of Optional Modules with Remote Accessories



CAUTION: Remove all power (AC and DC) before installing or removing modules or wiring.

RTB - Remote Trouble Buzzer

The RTB is a Remote Trouble Buzzer which provides a green AC Power LED and a yellow Trouble LED along with a piezo sounder, all of which mimic the condition of the control panel. The RTB can be mounted remotely in a single-gang electrical box. Four wires are required to connect the RTB to the MS-2410B control panel as illustrated in Figure 2-12.

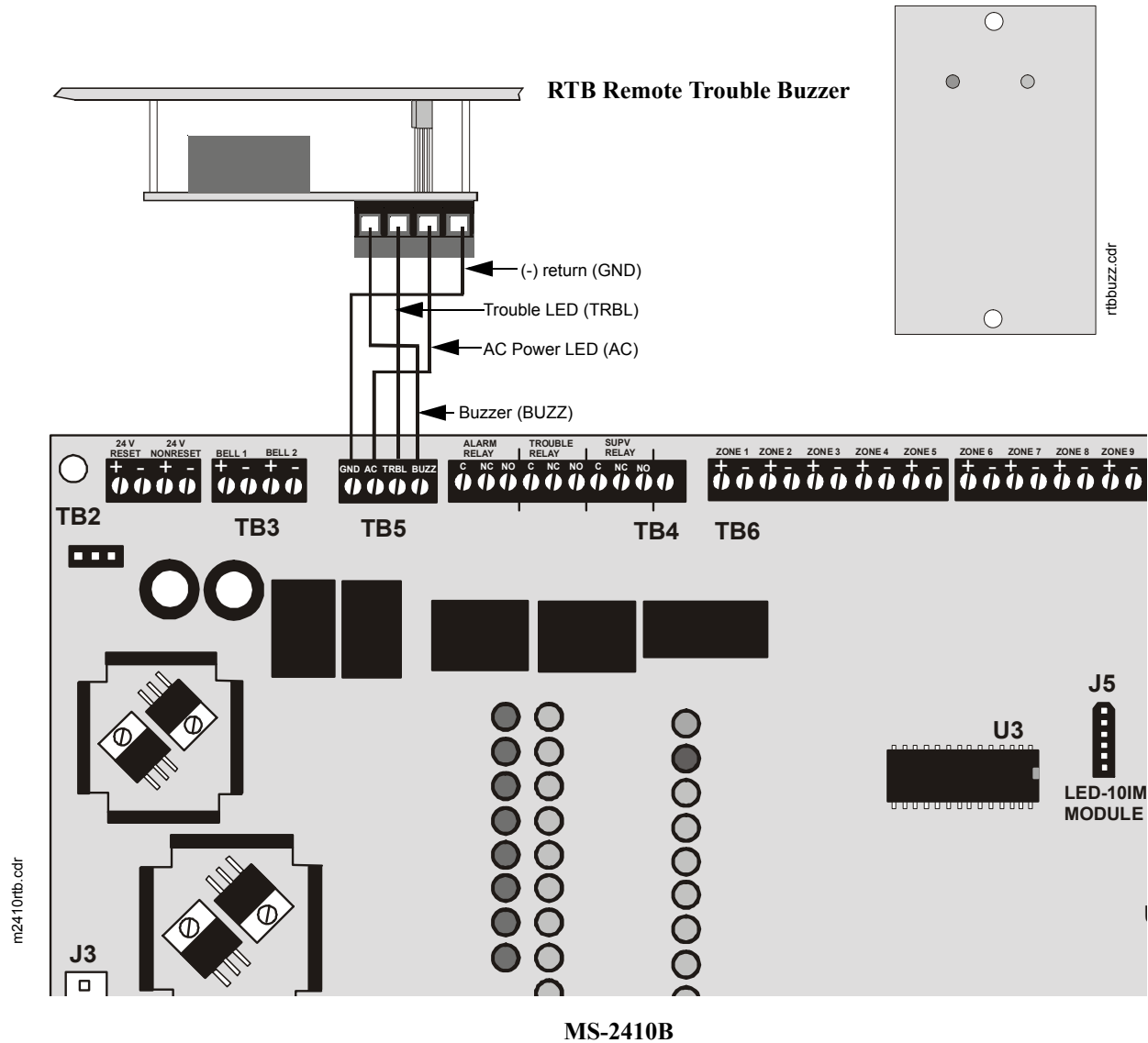

FIGURE 2-12:RTB Remote Trouble Buzzer

CAUTION: Remove all power (AC and DC) before installing or removing modules or wiring.



LED-10IM - EIA-485 Interface Module

The LED-10IM Interface Module provides an EIA-485 port to support the LED-10 Series Remote Annunciator and the ACM-8RF Relay Module. EIA-485 wiring is supervised for open circuits by this module. The LED-10IM mounts to connector J5 on the MS-2410B main board.

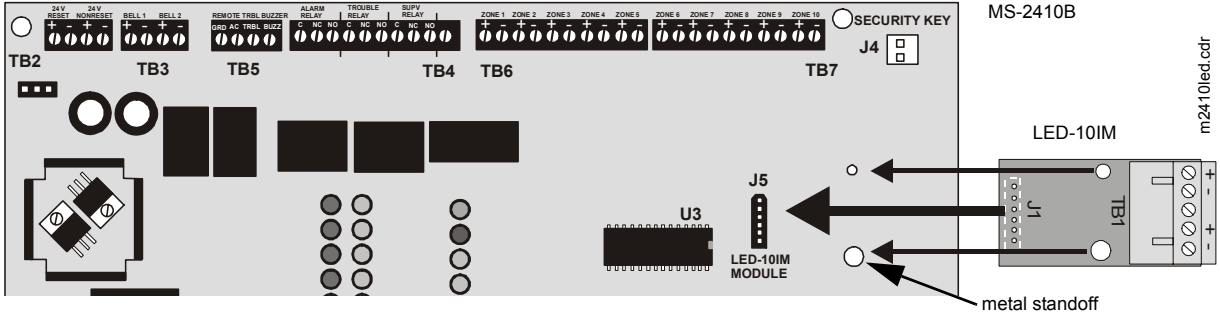

FIGURE 2-13:LED-10IM Installation

LED-10 Series Remote LED Annunciator

The LED-10 Series Annunciator connects to the MS-2410B via the LED-10IM Interface Module. It is recommended that overall foil/braided-shielded, twisted pair cable with a maximum length of 6,000 feet (1,800 m) @ 18 AWG (0.75 mm²) be used. Filtered power can be supplied by the MS-2410B or a remote UL listed filtered, power supply such as the Fire•Lite FCPS-24F(E).

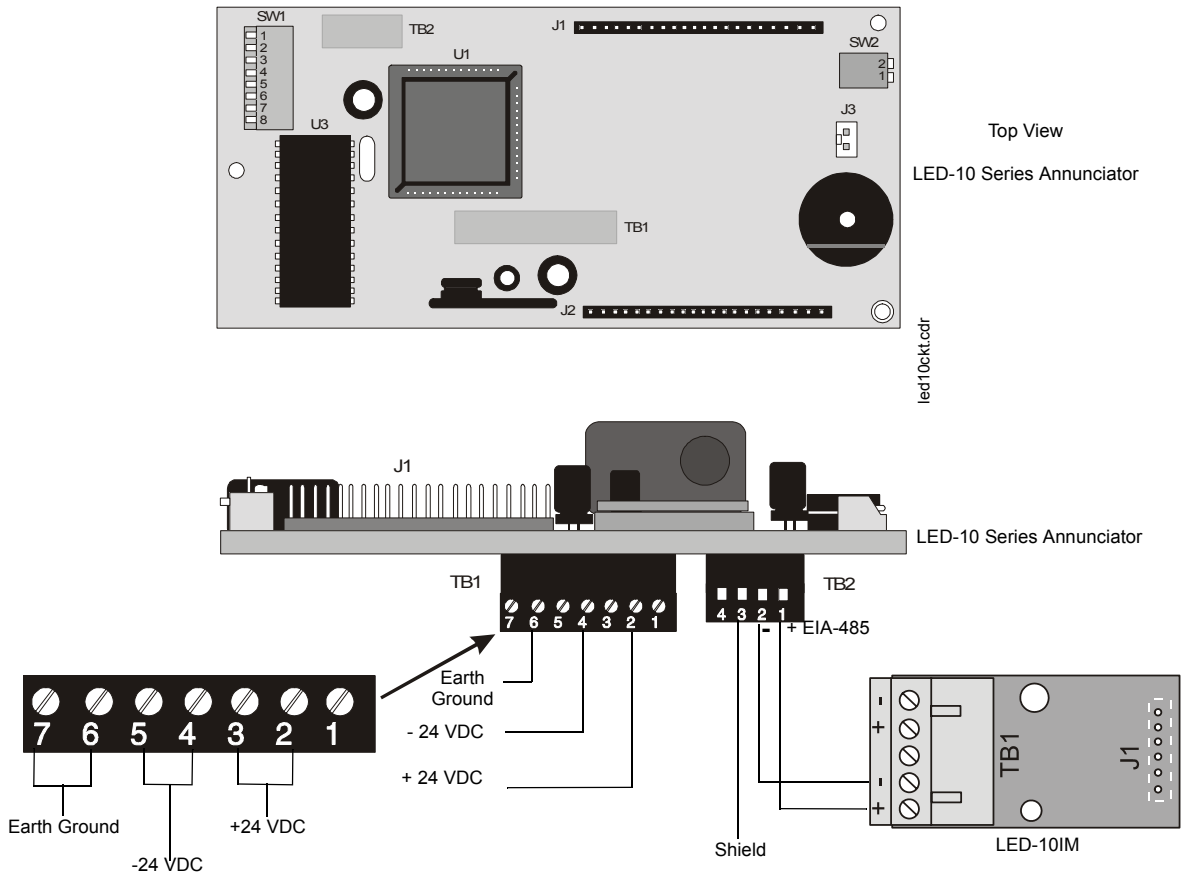

FIGURE 2-14:Wiring LED-10IM to LED-10 Series



CAUTION: Remove all power (AC and DC) before installing or removing modules or wiring.

ACM-8RF Remote Relay Module

The ACM-8RF Module provides eight Form-C relays with contacts rated for 5.0 amps. Relays can be assigned to each of the ten Initiating Device Circuits (two ACM-8RF relay modules are required). The module is installed on the EIA-485 line using the LED-10IM Interface Module. Communication wiring is supervised by the FACP. Power for the module must be power-limited. Refer to the ACM-8RF Manual for power-limited wiring requirements and switch SW4 receive/transmit selection option.

Removable terminal blocks are provided for ease of installation and servicing. DIP switch SW3 allows assignment of relays to FACP IDCs. The ACM-8RF module can be mounted remotely in an ABS-8RF annunciator surface-mount backbox.

ACM-8RF Address and SW3 DIP Switch Settings -

Each of the ten MS-2410B IDCs can be assigned to an ACM-8RF relay. Two relay modules are required, with both set to the same address. Use the decade rotary switches to set the address (i.e. for address '01', position the first [left] switch so the arrow points to '0' and the second [right] switch so the arrow points to '1'). Refer to Table 3-10, "Annunciator Addressing - Zone 8 Alarm LED," on page 41.

- ✓ To assign the first eight relays of the first ACM-8RF Relay Module to FACP IDCs 1 through 8, set ACM-8RF SW3 DIP switches 2 and 5 ON and 1, 3, 4, 6, 7 and 8 OFF.
- ✓ To assign the first two relays of the second ACM-8RF Relay Module to FACP IDCs 9 and 10, set ACM-8RF SW3 DIP switches 3 and 5 ON and 1, 2, 4, 6, 7 and 8 OFF.

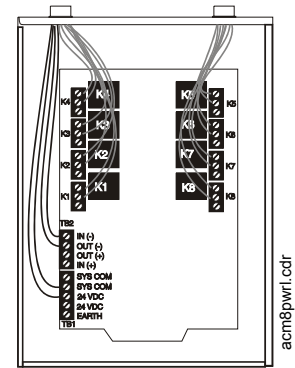

FIGURE 2-15:ABS-8RF

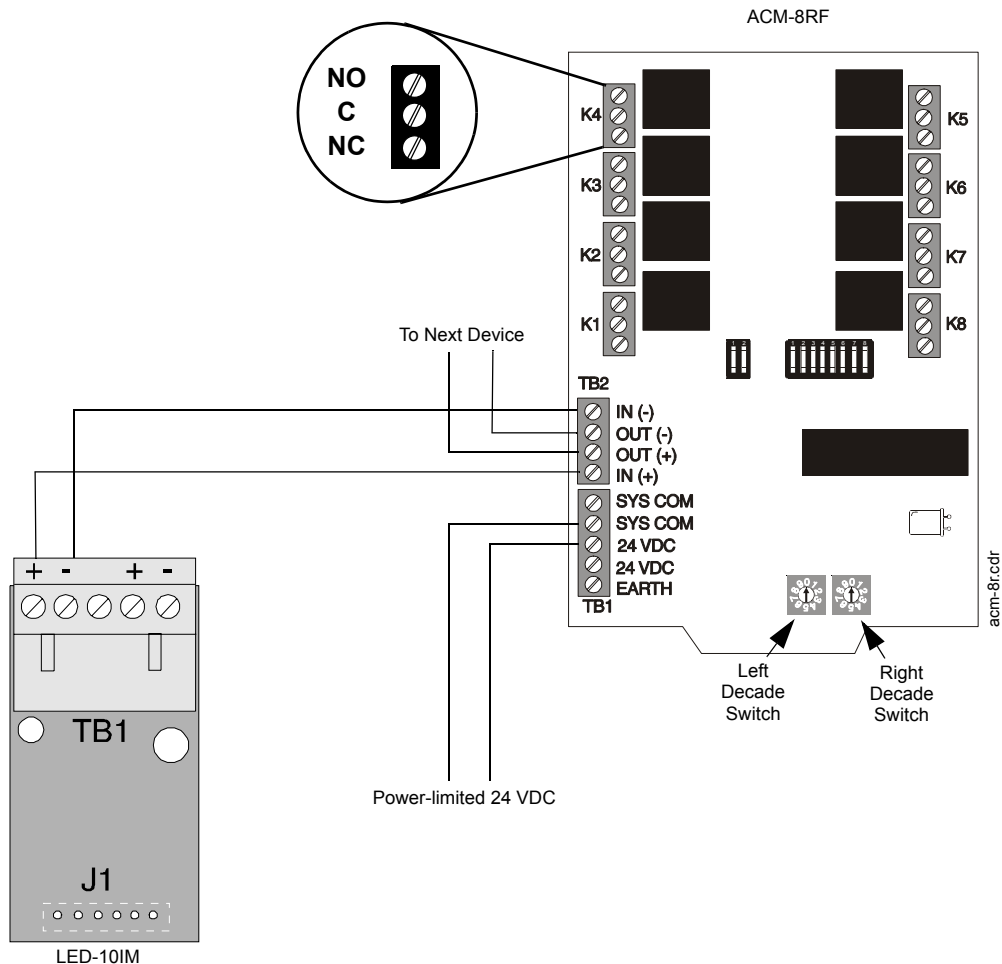

FIGURE 2-16:Wiring LED-10IM to ACM-8RF



CAUTION: Remove all power (AC and DC) before installing or removing modules or wiring.

4XTMF Transmitter Module

Push the disconnect switch to the down position to prevent accidental activation of the municipal box during testing of the control panel. The Disconnect LED will remain illuminated while the municipal box is disconnected. The System Trouble LED will indicate disconnected and/or open circuit conditions on the municipal box. During trouble conditions, it is possible to obtain the circuit condition on the alarm reverse polarity output. If this operation is desired, cut the TBL jumper on the 4XTMF module.

For Local Energy Municipal Box Service (NFPA 72 Auxiliary Fire Alarm Systems):

- Supervisory Current: 5.0 mA.
- Trip Current: 350 mA (subtracted from notification appliance power).
- Coil Voltage: 3.65 VDC.
- Maximum Coil Resistance: 14.6 ohms.
- Maximum allowable wire resistance between panel and trip coil: 3 ohms.
- Municipal Box wiring can leave the building.

For Remote Station Service (NFPA 72 Remote Station Fire Alarm Systems) - Intended for connection to a polarity reversal circuit or a Remote Station receiving unit having compatible ratings:

- Maximum load for each circuit: 10 mA.
- Reverse polarity output voltage: 24 VDC.
- Remote Alarm and Remote Trouble wiring can leave the building.

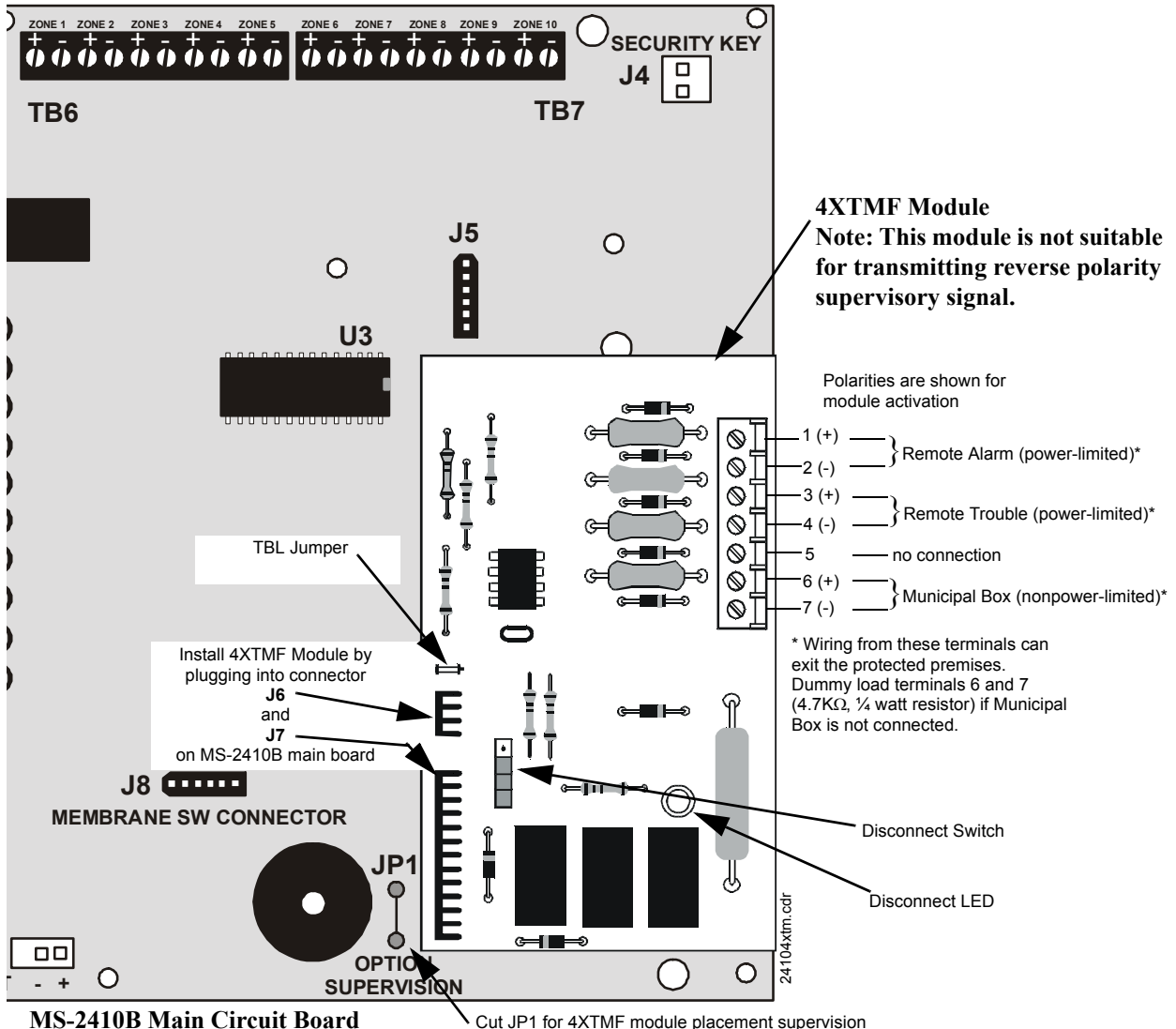

FIGURE 2-17:4XTMF Module Connections

CHAPTER 3 *Programming Instructions*

This chapter describes programming the MS-2410B from the onboard keypad. Control panel programming is possible at any time except when an alarm or zone fault condition is present or during a fire drill.

All programming selections are stored in nonvolatile Electrically-Erasable Programmable Read-Only Memory (EEPROM). This ensures that the control panel will remember all entries made in programming mode even if both AC and battery power are removed.

The control panel comes with factory chosen options already programmed. Other options may be programmed if desired. If all factory default settings are acceptable, programming is complete.

Successful entry into Program Mode from the keypad shuts off the fire protection and causes the Trouble LED and AC Power LED to flash.

3.1 Switch Functions

For ease of programming, labels have been provided which list the programming features/options available and the key functions in Programming Mode. Insert the supplied labels in the proper locations. Refer to “Slide-in Labels” on page 57. The function of each key in Program Mode is illustrated below:

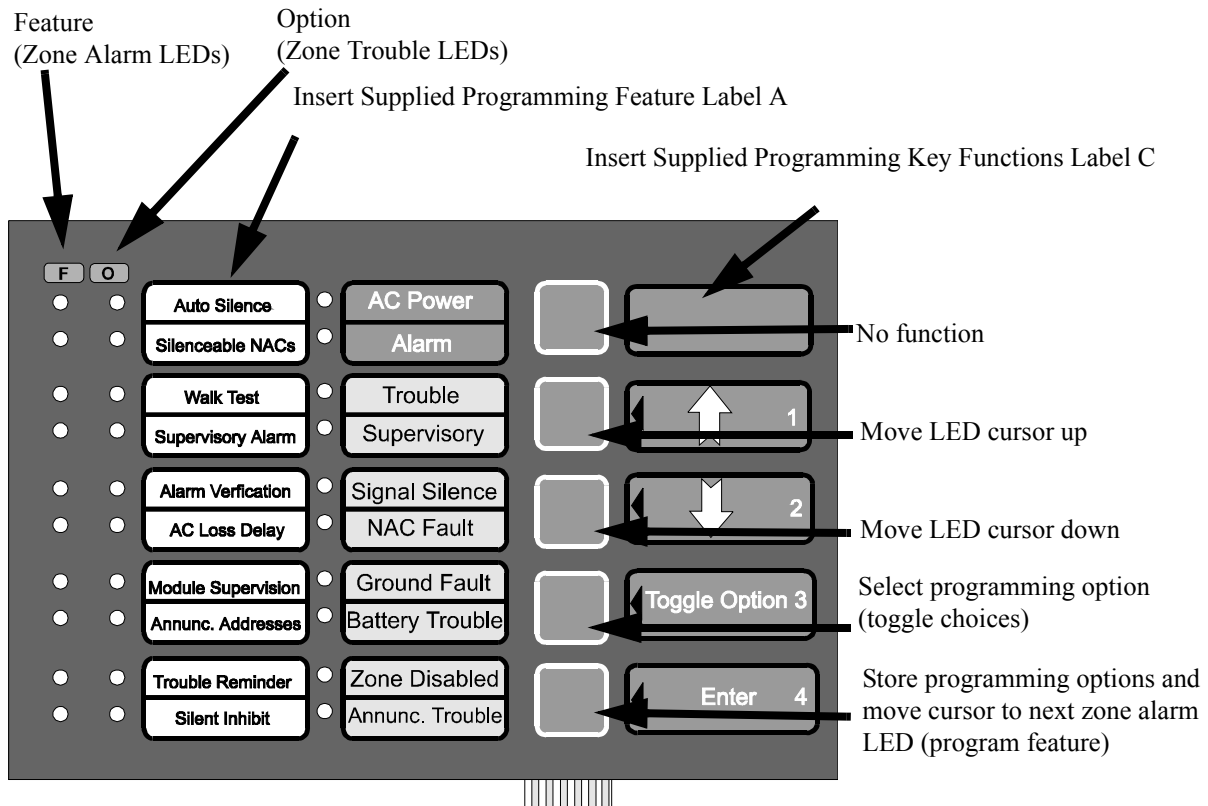

3.2 Programmable Features and Options

Table 3-1 lists the MS-2410B programmable features and the corresponding options available for each feature. In programming mode, the zone alarm LEDs are used to 'point' to the program feature and the zone trouble LEDs are used to select the desired option for each feature.

TABLE 3-1: Programming Features and Options

Zone Alarm LED	Programmable Features	Zone Trouble LED	Available Options
1	AUTO-SILENCE	1	Disabled - default
		2	Five (5) Minutes
		3	Ten (10) Minutes
		4	Twenty (20) Minutes
2	SILENCEABLE NAC	1	NAC 1 & NAC 2 Silenceable (factory default)
		2	NAC 1 Silenceable, NAC 2 Nonsilenceable
		3	NAC 2 Silenceable, NAC 1 Nonsilenceable
		4	NAC 1 & NAC 2 Nonsilenceable
3	WALKTEST	1	Audible (LED Off) - default Silent (LED On)
4	SUPERVISORY ALARM	1	Zone 9 Latching (LED On) - default Zone 9 Autoresettable (LED Off)
		2	Zone 10 Latching (LED On) - default Zone 10 Autoresettable (LED Off)
		3	Zone 9 Supervisory (LED Off) - default Zone 9 Smoke Zone (LED On)
		4	Zone 10 Supervisory (LED Off) - default Zone 10 Smoke Zone (LED On)
		5	Canadian Supervisory Enabled (LED On) Canadian Supervisory Disabled (LED Off) - default
5	ALARM VERIFICATION	1	Verify Alarms (LED On) Do Not Verify Alarms (LED Off) - default
6	AC LOSS DELAY	1	No Delay - default
		2	Six (6) Hour Delay
		3	Eight (8) Hour Delay
		4	Ten (10) Hour Delay
		5	Twelve (12) Hour Delay
		6	Fourteen (14) Hour Delay
		7	Sixteen (16) Hour Delay
		8	Eighteen (18) Hour Delay
7	MODULE SUPERVISION	1	4XTMF Transmitter Module
		2	not used
		3	LED-10IM (EIA-485) Module
8	ANNUNCIATOR MAXIMUM MONITORED ADDRESS	1	01 - default
		2	02
		3	03
		4	04
		5	05
		6	06
		7	07
		8	08
		9	09
		10	10
9	TROUBLE REMINDER	1	Disabled (LED Off) - default Enabled (LED On)
10	SILENCE INHIBIT	1	Disabled - default
		2	30 Second Silence Inhibit
		3	60 Second Silence Inhibit
		4	90 Second Silence Inhibit
		5	120 Second Silence Inhibit

3.3 Entering Program Mode

The keypad is enabled, to allow switching from Normal Mode to any other mode, by inserting the Security Key into connector J4 on the MS-2410B main circuit board.

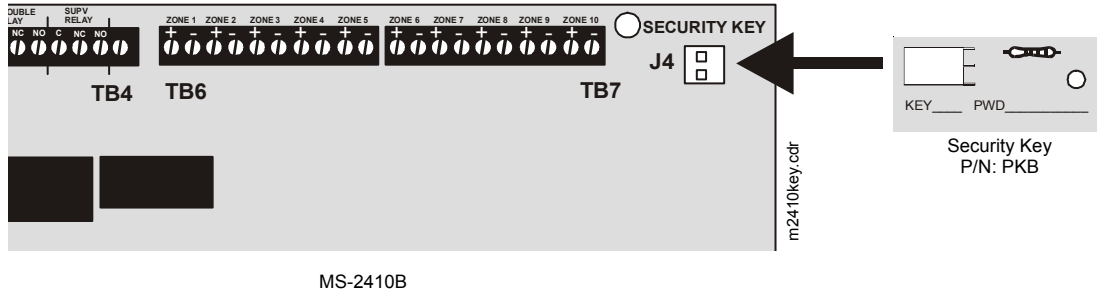

FIGURE 3-1: Programming Security Key - Program Mode

Insertion of the Security Key alters the functions of the keypad. Keys labeled 1 through 4 may now be used for entering a numerical password. Programming Mode can be entered by keying in the Program Mode password (1231232) and pressing the **Enter** key. If an incorrect key is pressed, wait 10 seconds and then reenter the proper password before pressing the **Enter** key.

A pause of up to 10 seconds is allowed between each key press while entering the password. After pressing the **Enter** key, the control panel will be in Program Mode with the keypad key functions configured for this mode. The system Trouble LED and AC Power LED will blink at a rate of 1 second On and 1 second Off and the trouble relay will activate. The Zone 1 alarm LED will turn on steady, the Zone 1 trouble LED will be mostly on (blink 3/4 second On and 1/4 second Off) if the corresponding option has been selected (factory default). A pause of up to 10 minutes is now allowed between each key press while in Programming Mode. Delays longer than 10 minutes will cause the control panel to exit Programming Mode. To enter any other mode, the Security Key must be removed and then reinserted. The appropriate password can then be entered.

Once in Programming Mode, the control panel will:

- ✓ Blink the system Trouble LED and AC Power LED
- ✓ Activate the trouble relay
- ✓ Disable the Notification Appliance Circuit(s)
- ✓ Disable the alarm relay
- ✓ Turn the Zone 1 alarm LED on steady upon first entering Program Mode
- ✓ Blink the Zone 1 trouble LED upon first entering Program Mode
- ✓ Turn on one or more additional Zone trouble LEDs
- ✓ Disable all Normal Mode keypad functions other than those mentioned in this section



CAUTION: The Security Key must be removed from connector J4, upon completion of programming functions, to ensure proper operation of the control panel.

3.4 Programming Function

The zone alarm and zone trouble LEDs are used as indicators for the programming features and options. The zone alarm LEDs are used to indicate the control panel feature being programmed. The Zone trouble LEDs indicate the available options for the selected feature.

Upon entering Program Mode, the Zone 1 alarm LED should be on steady, the Zone 1 trouble LED should be blinking and additional zone trouble LEDs, representing the selected options, may be on steady. The zone alarm LED that is on steady, acts as a 'pointer', indicating the control panel feature that will be programmed. The blinking zone trouble LED acts as a 'cursor', indicating the option for the currently selected program feature. The **Up** and **Down** arrow keys can be used to position the 'cursor' at any Zone trouble LED.

3.4.1 Program Feature Selection

Position the 'pointer' at the zone alarm LED, corresponding to the program feature that is to be changed, by pressing the **Enter** key. Refer to Table 3-2, "Program Feature Indicated by Alarm Zone," on page 37, for a listing of all program features and their corresponding alarm zones. Repeated presses of the **Enter** key will move the 'pointer' through all 10 zone alarm LEDs without changing any options.

As the 'pointer' is positioned at each zone alarm LED, the Zone 1 trouble LED will blink and additional zone trouble LEDs may light steady, indicating the options selected for that program feature.

3.4.2 Programming Options

The zone trouble LEDs are used to indicate the programming options for each feature. The 'cursor' (blinking LED) will be positioned initially at the Zone 1 trouble LED. Note that additional zone trouble LEDs may be on steady if the corresponding option has been previously programmed for the current feature. Use the **Up** and **Down** arrow keys to position the 'cursor' at the zone trouble LED corresponding to the option which is to be programmed. Press the keypad **3** key (Disable/Enable) to toggle between selecting and deselecting the option. Following option selection for the current control panel feature, press the **Enter** key to store the selection and move the 'pointer' to the next feature (zone alarm LED). Enabling or selecting an option will cause the corresponding zone trouble LED to turn on steady when the 'cursor' is moved off the LED.

Note that the normal blink rate of the 'cursor' (blinking LED), when positioned on an option that is disabled or not selected, is mostly off (1/10 second On and 9/10 second Off). If the 'cursor' is positioned on an option that is selected or enabled, the blink rate will be mostly on (9/10 seconds On and 1/10 second Off).

3.4.3 Programming Example

In this example, the Supervisory Alarms will be programmed so that both Zones 9 and 10 are auto-resettable supervisory circuits. Refer to Table 3-2, "Program Feature Indicated by Alarm Zone," on page 37, to see that the Supervisory Alarms feature corresponds to Zone 4 alarm LED.

1. Insert the Security Key into connector J4 on the MS-2410B main circuit board

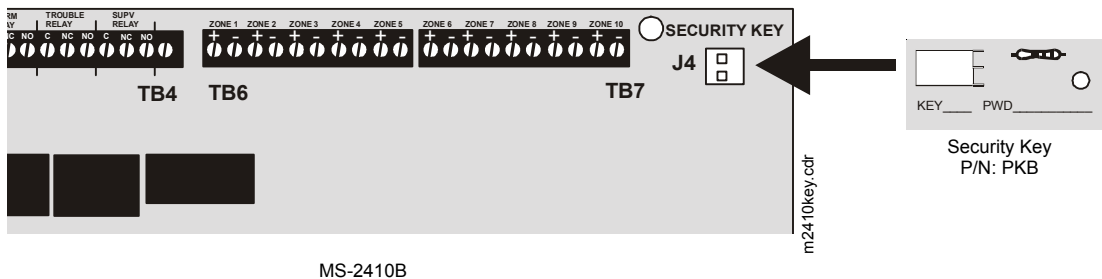

- Using the numerical keys, enter the Program Mode password and press the **Enter** key

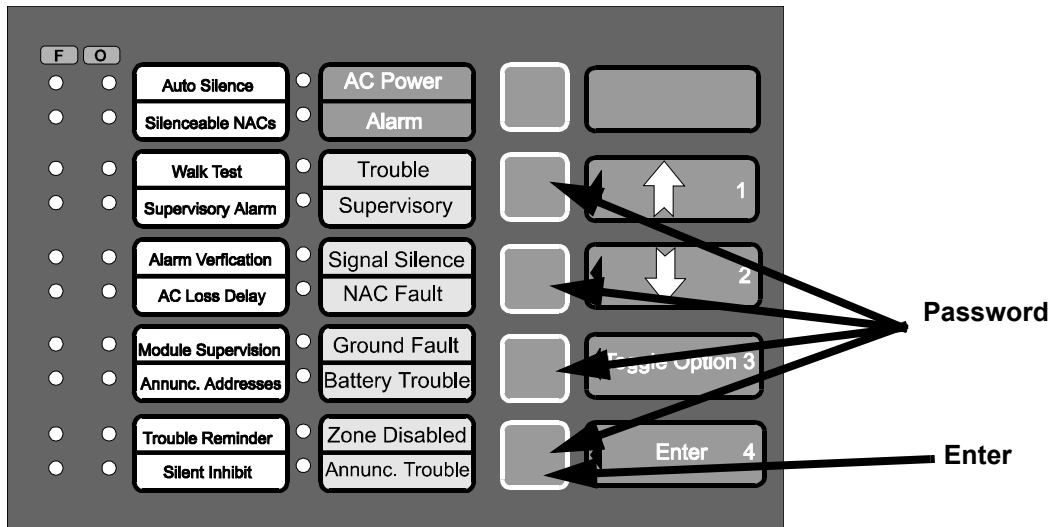

- The 'pointer' will be located at the Zone 1 alarm LED which will be on steady
- The 'cursor' will be located at the Zone 1 trouble LED which will blink and one or more additional zone trouble LEDs may be on steady

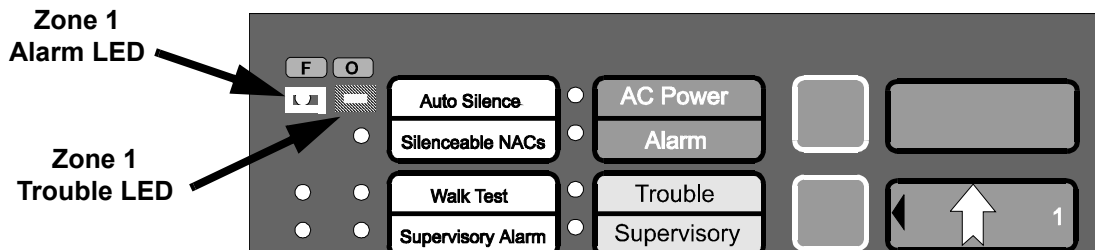

- Press the **Enter** key three times to position the 'pointer' at Zone 4 alarm LED, which corresponds to the Supervisory Alarms program feature
- The 'cursor' should be positioned at Zone 1 trouble LED which corresponds to the Zone 9 latching/auto-resettable option. Refer to Table 3-6, "Supervisory Alarm - Zone 4 Alarm LED," on page 39. Note that additional zone trouble LEDs may be on if corresponding options were previously selected

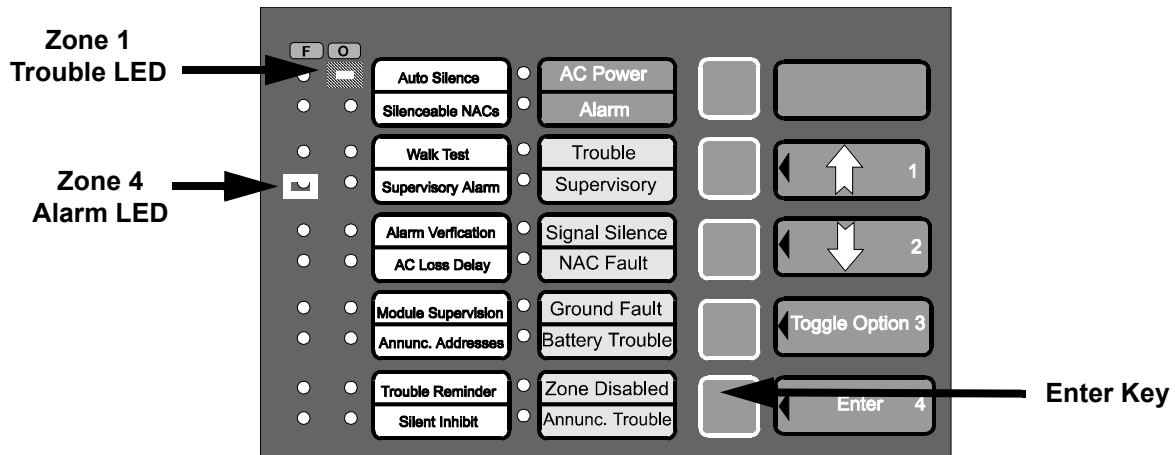

Programming Function

7. Press the keypad 3 key (Toggle Option) to select the auto-resettable option. Repeated pressing of the 3 key will toggle between the two available options

Note that in this option, latching is either enabled or disabled. If latching is disabled, the auto-resettable option is automatically selected. Since latching is disabled, the 'cursor' will blink at a 1/10 second On and 9/10 second Off rate. The LED will turn off when the cursor is moved off of it

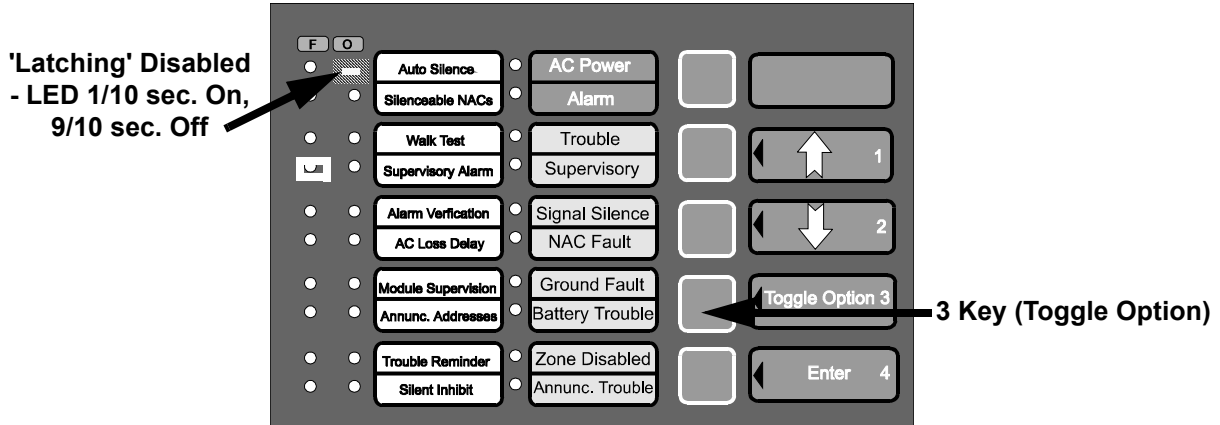

8. Press the Down arrow key to position the 'cursor' at the Zone 2 trouble LED which corresponds to the Zone 10 latching/auto-resettable option. Refer to Table 3-6, "Supervisory Alarm - Zone 4 Alarm LED," on page 39
9. Press the keypad 3 key (Toggle Option) to select the auto-resettable option. The cursor should blink at a 1/10 second On and 9/10 second Off rate (refer to step 7). The LED will turn off when the cursor is moved off of it

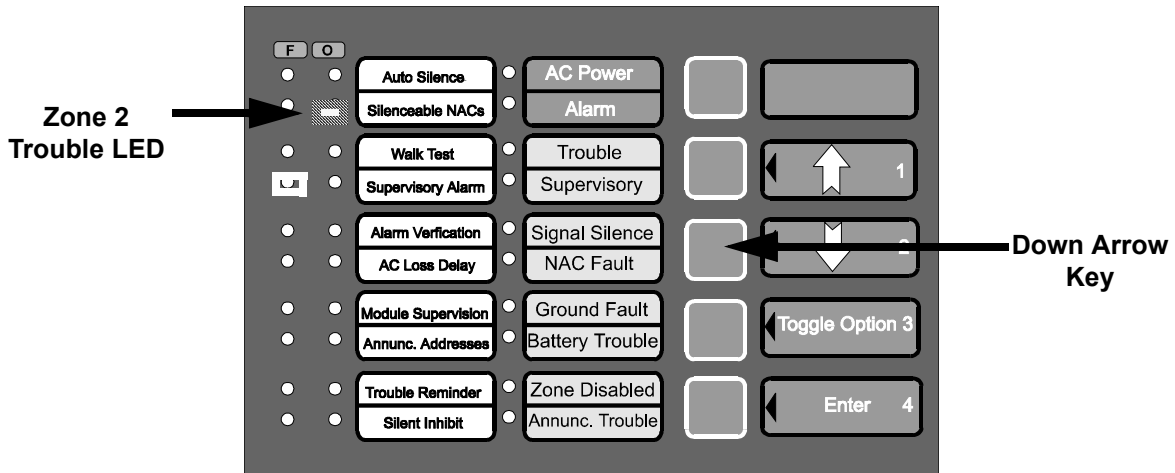

10. Press the Down arrow key to position the 'cursor' at the Zone 3 trouble LED which corresponds to the Zone 9 Smoke/Supervisory option. Refer to Table 3-6, "Supervisory Alarm - Zone 4 Alarm LED," on page 39
11. Press the keypad 3 key (Toggle Option) to select the Supervisory option. The cursor should blink at a 1/10 second On and 9/10 second Off rate. The LED will turn off when the cursor is moved off of it

Note that in this option, supervisory is either enabled or disabled. If supervisory is disabled, the smoke option is automatically selected. Since supervisory is enabled, the 'cursor' will blink at a 1/10 second On and 9/10 second Off rate. The LED will turn off when the cursor is moved off of it

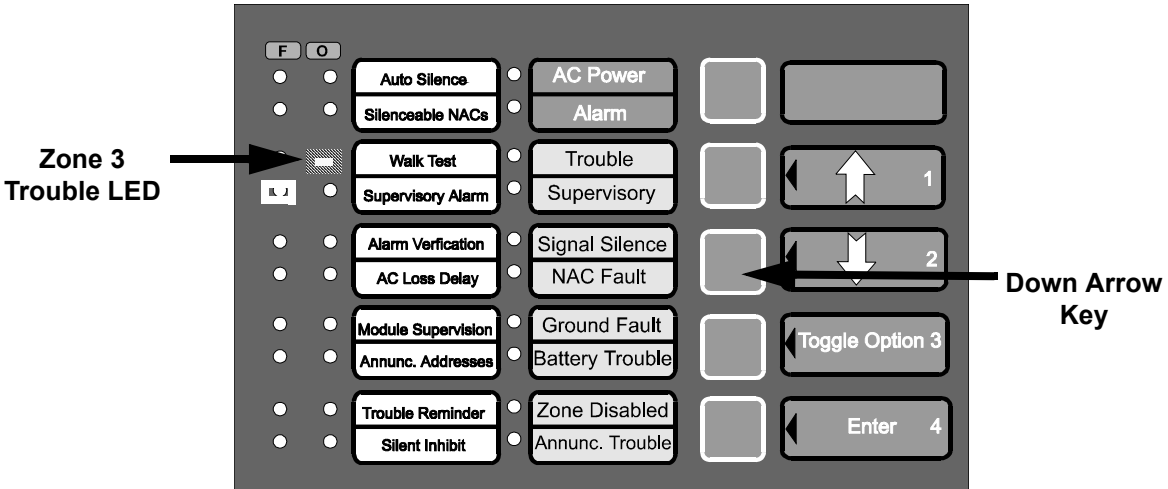

12. Press the Down arrow key to position the 'cursor' at the Zone 4 trouble LED which corresponds to the Zone 10 Smoke/Supervisory option. Refer to Table 3-6, "Supervisory Alarm - Zone 4 Alarm LED," on page 39
13. Press the keypad 3 key (Toggle Option) to select the Supervisory option. The cursor should blink at a 1/10 second On and 9/10 second Off rate (refer to step 11). The LED will turn off when the cursor is moved off of it

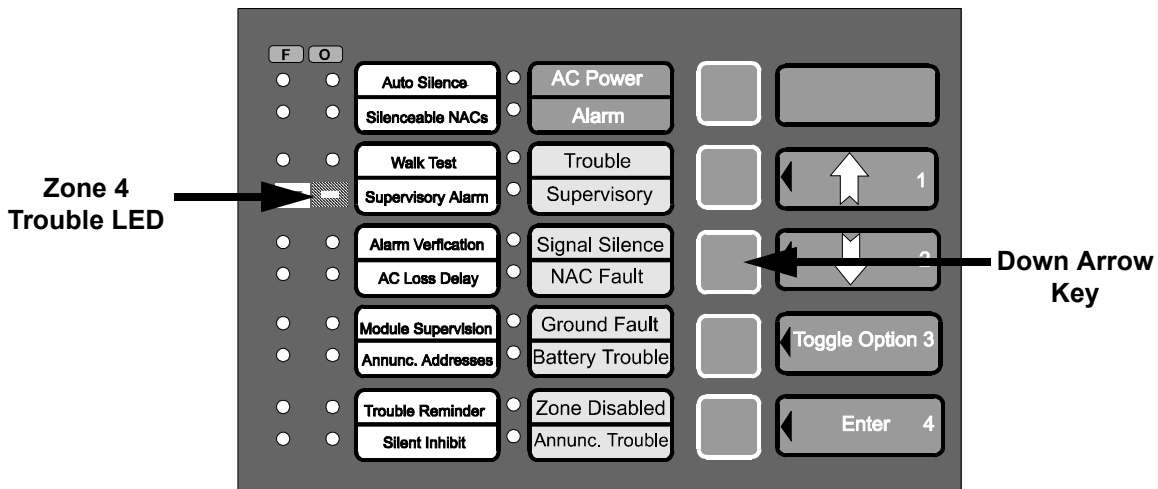

Program Features and Options

- 14. Press the Down arrow key to position the 'cursor' at the Zone 5 trouble LED which corresponds to the Canadian Supervisory option. Refer to Table 3-6, "Supervisory Alarm - Zone 4 Alarm LED," on page 39
- 15. Press the keypad 3 key (Toggle Option) to disable the Canadian Supervisory option. The cursor should blink at a 1/10 second On and 9/10 second Off rate. The LED will turn off when the cursor is moved off of it

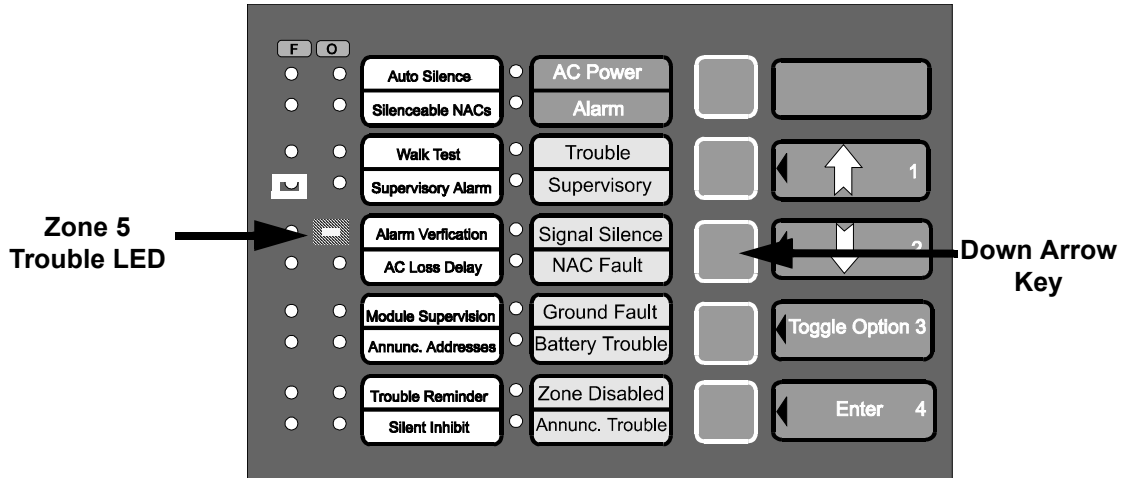

- 16. Press the **Enter** key to store all of the selected options for the Supervisory Alarms feature and move the pointer to the next feature

3.5 Program Features and Options

3.5.1 Program Features

There are ten features that are programmable through the MS-2410B keypad. Table 3-2 lists the programming features and the alarm zones which represent each feature.

TABLE 3-2: Program Feature Indicated by Alarm Zone

Alarm Zone LED Number (red)	Programming Feature
1	Auto-silence
2	Silenceable NACs
3	Walktest (audible/silent)
4	Supervisory Alarms
5	Alarm Verification
6	AC Loss Delay
7	Option Module Supervision
8	Number of Annunciators
9	Trouble Reminder
10	Silence Inhibit

3.5.2 Programming Options

Each programming feature listed in Table 3-2 has two or more options associated with it. This section describes each feature and the available options.

Note that the normal blink rate of the 'cursor' (blinking LED), when positioned on an option that is disabled or not selected, is mostly off (1/10 second On and 9/10 second Off) so they may appear dimly lit. If the 'cursor' is positioned on an option that is selected or enabled, the blink rate will be mostly on (9/10 seconds On and 1/10 second Off) so they will appear brightly lit.

Auto-silence

Auto-silence is the program feature that will automatically silence the Notification Appliance Circuits, if they are programmed as silenceable circuits, after a programmed time interval. The factory default setting is auto-silence disabled. *Note that one and only one of the four selections must be selected or the panel will not allow the programmer to continue.*

TABLE 3-3: Auto-silence Program Options - Zone 1 Alarm LED

Trouble Zone LED Number (yellow)	Auto-silence Program Options
1	Disabled (factory default)
2	Five (5) Minutes
3	Ten (10) Minutes
4	Twenty (20) Minutes

Silenceable NACs (Notification Appliance Circuits)

This feature, if enabled, allows the silencing of Notification Appliance Circuits. The two circuits can be programmed independently for silenceable (enabled) or nonsilenceable (disabled) operation.

TABLE 3-4: Silenceable NACs - Zone 2 Alarm LED

Trouble Zone LED Number (yellow)	Silenceable NAC Program Options
1	NAC 1 & NAC 2 both silenceable (factory default)
2	NAC 1 silenceable, NAC 2 nonsilenceable
3	NAC2 silenceable, NAC 1 nonsilenceable
4	NAC 1 & NAC 2 both nonsilenceable

Walktest

The MS-2410B provides the capability to perform a walktest of the system without triggering the optional ACM-8RF zone relays, the system annunciators or the alarm output relay. Walktest allows the testing of the 10 Initiating Device Circuit zones. An audible or silent walktest may be performed.

For an audible walktest, the first initiating device activated on a zone will cause the Notification Appliance Circuits to turn on for four seconds. Subsequent device activations on the same zone will cause the NACs to turn on for one second. Any smoke detectors that are activated will be reset. Zone faults (open circuits) will cause the NAC to remain on steady until the fault is cleared. Silent walktest will be indicated by LEDs and piezo sounder at the control panel only, without activating the NACs.

TABLE 3-5: Walktest - Zone 3 Alarm LED

Trouble Zone LED Number (yellow)	Walktest Program Options
1	Audible (factory default) = LED Off Silent = LED On

Supervisory Alarms

Zones 9 and 10 can be programmed for activation on Supervisory alarm or Smoke alarm. Zones are programmed for supervisory where a waterflow sensing device has been employed and the wiring to the waterflow valve and/ or tamper switch is to be monitored. If the tamper switch has been activated (normally open contacts close), a supervisory alarm condition will occur and the zone's supervisory alarm red LED will blink.

A supervisory zone can be programmed for latching, which requires a panel reset to restore the zone after clearing the supervisory alarm, or auto-resettable, which will automatically restore the zone after the supervisory alarm is cleared. *Note: Do not select auto-resettable if the zone is programmed as a smoke zone.*

Program Features and Options

The Canadian Supervisory option functions in the same manner as the non Canadian Supervisory option except the zone's supervisory alarm LED is yellow.

TABLE 3-6: Supervisory Alarm - Zone 4 Alarm LED

Trouble Zone LED Number (yellow)	Supervisory Alarm Program Options
1	Enable Latching (factory default) = Zone 9 latching - LED On Disable Latching = Zone 9 auto-resettable - LED Off
2	Enable Latching (factory default) = Zone 10 latching - LED On Disable Latching = Zone 10 auto-resettable - LED Off
3	Enable Zone 9 Supervisory = Supervisory zone (factory default) - LED Off Disable Zone 9 Supervisory = Smoke zone - LED On
4	Enable Zone 10 Supervisory = Supervisory zone (factory default) - LED Off Disable Zone 10 Supervisory = Smoke zone - LED On
5	Enable Canadian Supervisory - LED On Disable Canadian Supervisory - LED Off (factory default)

Alarm Verification

Alarm verification can be used only on zones 1 through 3. Two-wire smoke detectors alone should be installed on all verified zones. After detecting a smoke detector activation on a verified zone, the panel removes power from all zones for six seconds, resetting all 2-wire smoke detectors and normally open devices on nonverified zones. A subsequent 12 second retard period allows detectors to stabilize. During the combined retard/reset period of 18 seconds, alarms by the same initiating zone are ignored. An alarm detected on any other zone, during the retard period, will cause immediate verified alarms. A subsequent alarm on the initiating zone occurring within the confirmation time will cause a verified alarm on the verified zone.

If a nonverified zone has pull stations installed, the NACs may activate up to a maximum of seven seconds following pull station activation if alarm verification has been initiated on zone 1, 2 or 3.

Note that during the alarm verification period, the zone trouble LED and the zone alarm LED for the zone being verified will blink at a ½ second On and ½ second Off rate and the piezo sounder will pulse at the same rate. Access to other modes of operation is prevented during alarm verification.

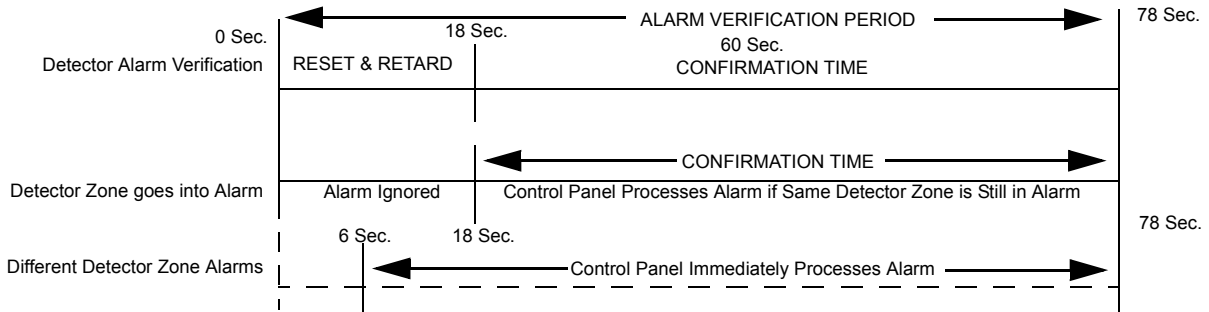

FIGURE 3-2: Verification Timing Diagram

Factory default selection is no verification. *Consult the Local Authority Having Jurisdiction (LAHJ) prior to enabling verification.*

TABLE 3-7: Alarm Verification- Zone 5 Alarm LED

Zone Trouble LED Number (yellow)	Alarm Verification Options
1	Enabled = Verify Alarm - LED On Disabled = Do Not Verify Alarm (factory default) - LED Off

AC Loss Delay

When AC power is lost or a brownout condition occurs (AC voltage drops below a predetermined level), the control panel trouble relay will activate. The factory default option for this feature is immediate trouble relay activation on AC loss or brownout. Relay activation may be delayed by selecting one of the seven available time delays as listed in the following table. *Note that one and only one of the eight options must be selected or the panel will not allow the programmer to continue.*

TABLE 3-8: AC Loss Time Delay - Zone 6 Alarm LED

Zone Trouble LED Number (yellow)	Trouble Relay Time Delay on AC Loss
1	No Delay (factory default)
2	Six (6) Hours
3	Eight (8) Hours
4	Ten (10) Hours
5	Twelve (12) Hours
6	Fourteen (14) Hours
7	Sixteen (16) Hours
8	Eighteen (18) Hours

Module Supervision Enabled

Two option modules may be installed in the MS-2410B control panel: the Reverse Polarity Module and LED-10IM (EIA-485) Module. When any module is installed, module placement supervision must be 'enabled' (LED On) for the particular module(s). In addition, when the Reverse Polarity Module is installed, jumper JP1 must be cut on the main circuit board. The factory default setting for module placement supervision for each module is 'disabled' (LED Off).

TABLE 3-9: Module Supervision - Zone 7 Alarm LED

Zone Trouble LED Number (yellow)	Module Placement Supervision
1	Reverse Polarity Module
2	Not Used
3	LED-10IM (EIA-485) Module

Annunciator Maximum Monitored Address

Devices with a maximum of ten different addresses may be connected to the EIA-485 port off of the LED-10IM module. Annunciator addresses must be set sequentially, beginning with '01' up to address '10', with no gaps between addresses. This feature must be set to the value of the highest annunciator address installed on the EIA-485 communication line.

Devices which may be connected to the EIA-485 port include LED-10 series annunciators and ACM-8RF relay modules. Included on the LED-10 series and ACM-8RF are switches which are used to select an address for the annunciator. For each device added or connected to the EIA-485 port via the LED-10IM, select a unique address on each annunciator, with the exception of the ACM-8RF. If multiple ACM-8RF modules are installed, all ACM-8RFs must be set to the same address (refer to the applications section of the ACM-8RF Manual P/N 50362). Addresses must be sequential with no gaps allowed. For example, if devices with seven different addresses are connected to the EIA-485 port, the maximum monitored address value entered into this option must be '7'. If the maximum number of devices with 10 different addresses are connected, the maximum monitored address entered into this option must be '10'.

Program Features and Options

All devices connected to the EIA-485 are fully supervised by the FACP. .

TABLE 3-10:Annunciator Addressing - Zone 8 Alarm LED

Zone Trouble LED Number (yellow)	Highest Installed Annunciator Address
1	01 - default
2	02
3	03
4	04
5	05
6	06
7	07
8	08
9	09
10	10

Trouble Reminder

The Trouble Reminder feature provides an audible reminder that an alarm or trouble still exists on the FACP after the control panel has been silenced. The factory default for this feature is 'disabled'. When this feature is 'enabled', the control panel piezo sounder will pulse once every 15 seconds during an alarm and every two minutes during a trouble condition, after the Signal Silence or Acknowledge switch is pressed. The piezo will continue to sound at these rates until the alarm or trouble condition is cleared.

TABLE 3-11:Trouble Reminder - Zone 9 Alarm LED

Zone Trouble LED Number (yellow)	Trouble Reminder
1	Disabled = LED Off (factory default) Enabled = LED On

Silence Inhibit

The Silence Inhibit feature prevents the silencing of Notification Appliance Circuits, using the Signal Silence switch or Reset switch, for the amount of time corresponding to the selected option, after the NACs are activated. The factory default for this feature is 'disabled'

TABLE 3-12:Silence Inhibit - Zone 10 Alarm LED

Zone Trouble LED Number (yellow)	Silence Inhibit
1	Disabled (factory default)
2	30 Second Silence Inhibit
3	60 Second Silence Inhibit
4	90 Second Silence Inhibit
5	120 Second Silence Inhibit

3.6 Default Programming Mode

The original factory default options can be programmed into the MS-2410B by entering Default Programming Mode. The keypad is enabled, to allow switching from Normal Mode, by inserting the Security Key into connector J4 on the MS-2410B main circuit board.

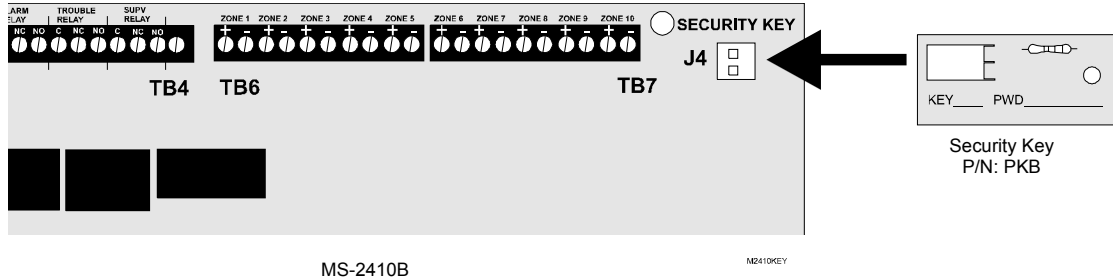

FIGURE 3-3: Programming Security Key - Default Programming Mode

Insertion of the Security Key alters the functions of the keypad. Insert the supplied programming keys function label C to view the new key functions. Keys labeled 1 through 4 may now be used for entering a numerical password. Default Programming Mode is entered by keying in the Program Mode password (**321321**) and pressing the **Enter** key twice. If an incorrect key is pressed, wait 10 seconds and then reenter the proper password before pressing the **Enter** key.

A pause of up to 10 seconds is allowed between each key press while entering the password. After pressing the **Enter** key, the control panel will enter Default Programming Mode. The original factory default programming is immediately restored and the control panel automatically returns to Normal Mode. Remove the programming label and reinsert the Normal Mode label C when the control panel is in Normal Mode of operation. To enter any other mode, the Security Key must be removed and then reinserted. The appropriate password can then be entered.

CAUTION: The Security Key must be removed from connector J4, upon completion of default programming, to ensure proper operation of the control panel.

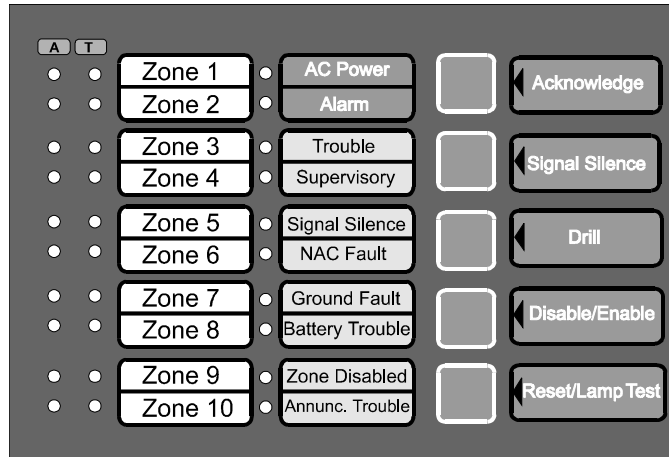

FIGURE 4-1: LED Indicators and Keypad

The MS-2410B has five modes of operation which are Normal, Program, Walktest, Last Event (History) and Default. There are also two function modes: Zone Disable/Enable and Drill. *Upon initial power-up, the system will be in Normal Mode. This section discusses operation of the control panel in the Normal Mode.*

4.1 Switch Functions in Normal Mode

Acknowledge

An Acknowledge key is located on the MS-2410B keypad (refer to Figure 4-1), and may be remotely located on any of the LED-10 annunciators. The Acknowledge key silences the system piezo sounders and changes all flashing system LEDs to steady. Pressing the Acknowledge key will have no effect on the Notification Appliance Circuits.

Signal Silence

A Signal Silence key is located on the FACP keypad (illustrated in Figure 4-1), and may be remotely located on any of the LED-10 annunciators. If any of the Signal Silence keys are pressed, the following will occur:

- ✓ The silenceable Notification Appliance Circuits will be turned OFF
- ✓ The main circuit board Signal Silence LED will be turned ON
- ✓ The system piezo sounders are turned off

Upon the occurrence of a subsequent event (alarm or trouble), Signal Silence is overridden and the control panel will respond to the new event. *The Signal Silence keys will be ignored for nonsilenceable waterflow type alarms.*

Drill

A Drill key is located on the FACP keypad, and may be remotely located on any of the LED-10 annunciators. To perform a drill from any of these devices, the Drill key must be pressed and held for more than two seconds (time to prevent accidental activation). The MS-2410B turns on all NACs and turns off the Signal Silence LEDs if they were on. The alarm relay is not activated during a drill. The Signal Silence keys will silence all silenceable NACs during a fire drill and the Reset key will restore the FACP to Normal Mode.

Disable/Enable

The zone disable feature may be used to disable any zone in the system. Zones in alarm cannot be disabled but zones in trouble can be disabled.

To disable one or more zones, press and hold the **Disable/Enable** key. After two seconds, the FACP will enter Disable/Enable Mode. Continue pressing the **Disable/Enable** key to remain in this mode. Fire protection is still active while in this mode. Releasing the key will return the FACP to Normal Mode.

While pressing the **Disable/Enable** key, any zones that were previously disabled will be indicated by the zone trouble LED being on steady. A 'cursor' (blinking LED), which blinks at a 1/10 second On and 9/10 second off rate, will be positioned at the Zone 1 trouble LED. Note that if Zone 1 was previously disabled, the 'cursor' will blink at a 9/10 second On and 1/10 second Off rate.

To disable or enable a zone, continue pressing the **Disable/Enable** key and use the **Up** or **Down** arrow keys to position the 'cursor' at the alarm zone trouble LED. Press the **Reset (Enter)** key to toggle the zone from enabled to disabled or disabled to enabled. Note that the 'cursor' flash rate changes from 1/10 second On and 9/10 second Off when enabled, to 9/10 second On and 1/10 second Off when disabled. Using the arrow keys to move the 'cursor' away from the selected zone will cause the disabled zone's trouble LED to remain on steady. Continue this process for each zone to be enabled or disabled.

When all desired changes have been made, release the Disable/Enable key to return the FACP to Normal Mode. Note that the zone trouble LEDs for all disabled zones will be blinking along with the system trouble LED and the piezo will be sounding. Pressing the Acknowledge key will silence the piezo sounder and change the blinking LEDs to steady on.

Reset/Lamp Test

The System Reset key resets the system and any smoke detectors. A Reset key is located on the FACP keypad (illustrated in Figure 4-1), and may be remotely located on any of the LED-10 annunciators. If any of the System Reset keys are pressed, the control panel will:

- ✓ Clear the status LEDs
- ✓ Turn off the Notification Appliance Circuits
- ✓ Reset all zones by temporarily removing power
- ✓ Silence the onboard piezo sounder
- ✓ Restore all system relays to normal
- ✓ Temporarily remove power from the resettable power output TB2 Terminals 3 and 4

Any alarm, supervisory or trouble condition that exists after a system reset, will resound the system, reactivating normal system activity. Any zones that were disabled before the reset will remain disabled after the reset.

Lamp Test - If the Reset/Lamp Test key is pressed and held for more than two seconds, the FACP will perform a Lamp Test. All panel LEDs will be turned on and the piezo will sound until the Reset key is released.

4.2 Status LEDs

AC Power LED

A green LED that remains on while the AC power supply is within correct limits. *If this indicator fails to light under normal conditions, service the system immediately.*

Alarm LED

A red LED that flashes when a system fire alarm condition is detected. It turns on steady when the Signal Silence or Acknowledge keys are pressed.

Trouble LED

A yellow LED that blinks to indicate that a system fault or abnormal condition exists and that the fire alarm system may be inoperative. It turns on steady when a Signal Silence or Acknowledge key is pressed.

Operation

Supervisory LED (Zones 9 and 10 Only)

A yellow LED that blinks to indicate the need for action in connection with the supervision or maintenance of sprinklers, extinguishing systems or other protective systems. It turns on steady when a Signal Silence or Acknowledge key is pressed.

Signal Silence LED

A yellow LED that turns on to indicate that an Alarm condition exists in the system, but Notification Appliance Circuits (if programmed as silenceable) and local piezo sounder have been silenced.

NAC Fault LED

A yellow LED that blinks to indicate that an NAC Trouble condition exists in the system. LED turns on steady when a Signal Silence or Acknowledge key is pressed.

Ground Fault LED

A yellow LED that blinks to indicate a ground fault condition on the system. A ground fault occurs when a low resistance between the FACP and ground exists. It turns on steady when a Signal Silence or Acknowledge key is pressed.

Battery Trouble

A yellow LED that blinks to indicate a low battery or no battery condition on the FACP. It turns on steady when a Signal Silence or Acknowledge key is pressed.

Zone Disabled

A yellow LED that blinks to indicate that one or more alarm zones have been disabled using the Disable/Enable key. The disabled zone(s) trouble LED will also be on. It turns on steady when a Signal Silence or Acknowledge key is pressed.

Annunciator Trouble

A yellow LED that blinks to indicate that one or more remote annunciators are not responding correctly. It turns on steady when a Signal Silence or Acknowledge key is pressed.

Zone 1 through Zone 10 Alarm LED

Red LEDs that blink to indicate that an alarm exists on the corresponding zone. It turns on steady when a Signal Silence or Acknowledge key is pressed.

Zone 9 and Zone 10 Supervisory LED

If the zone(s) is programmed for supervisory, a yellow LED will blink to indicate that a supervisory condition exists on the corresponding zone. It turns on steady when a Signal Silence or Acknowledge key is pressed.

Zone 1 through Zone 10 Trouble LED

Yellow LEDs that blink to indicate that a fault or abnormal condition exists on the corresponding zone. It turns on steady when a Signal Silence or Acknowledge key is pressed.

4.3 Operation

Normal Mode is the standard mode of operation. In this mode, the panel continuously monitors system status. When no alarm or trouble conditions exist, all LEDs will be off (except the AC Power LED). The Notification Appliance Circuits will be off, all relays are in their normal state and the onboard piezo sounder will be off.

All alarm and system trouble conditions are annunciated on the control panel's LEDs. The control panel will maintain a 'last event list' which will consist of all alarms, supervisory alarms and system troubles currently active and not cleared, requiring immediate service. When the system is cleared and restored to normal, the LEDs will be off except for the AC Power LED. The last alarms and troubles are stored in a history file and may be recalled at any time.

Operation

Higher priority events take precedence over lower priority events. Display and reporting of System Status is done on a priority basis. Priorities are, from highest to lowest:

1. Alarms
2. Supervisory Alarms
3. System Troubles

4.3.1 Fire Alarm Response

The control panel will, upon detection of an alarm condition, cause the following:

- Blink the FACP system Alarm LED (1 second On, 1 second Off)
- Blink the Zone Alarm LED (1 second On, 1 second Off)
- Store the alarm in the Last Event/History File
- Turn the Notification Appliance Circuits on
- Turn the piezo sounder on steady¹
- Turn on appropriate zone relay output (ACM-8RF)
- Turn on alarm relay
- Blink all remote annunciator general alarm LEDs (1 second On, 1 second Off)

4.3.2 Fire Alarm Restoral

The control panel returns to normal after all alarms have been cleared and a system reset key has been pressed (pull stations have been reset, smoke detectors have reset and no smoke is present, waterflow has stopped). The control panel will perform the following upon restoral of all active alarms:

- Turn off the FACP alarm LED
- Turn off the Zone Alarm LED
- Turn off the Notification Appliance Circuits
- Turn off the piezo sounder
- Turn off appropriate zone relay output (ACM-8RF)
- Turn off alarm relay
- Turn off all remote annunciator general alarm LEDs
- Turn off all remote annunciator zone alarm LEDs

4.3.3 System Supervisory Condition Response

Only zones 9 and 10 can be programmed as Supervisory zones. These zones can be programmed for supervisory in applications where a waterflow sensing device has been employed and the wiring to the waterflow valve and/or a tamper switch is to be monitored. If the tamper switch has been activated (normally open contacts close), a supervisory alarm condition will occur.

When a supervisory condition occurs, the control panel will cause the following:

- Blink the FACP supervisory LED (½ second On, ½ second Off)
- Blink the Zone supervisory LED (½ second On, ½ second Off)
- Store the supervisory alarm in the Last Event/History File
- Pulse system piezo sounders (½ second On, ½ second Off)
- Turn on appropriate zone relay output (ACM-8RF)

1. If the Trouble Reminder option has been programmed, silencing the alarm will cause the piezo sounder to beep once every 15 seconds until the alarm condition is cleared.

Operation

- Turn on supervisory relay
- Blink all remote annunciator general supervisory alarm LEDs (½ second On, ½ second Off)
- Blink all remote annunciator zone supervisory alarm LEDs (½ second On, ½ second Off)

4.3.4 System Supervisory Restoral Response

When the supervisory condition has been cleared and the reset key has been pressed (if zones are programmed for latching), the control panel will perform the following:

- Turn off the supervisory LED
- Turn off the Zone supervisory LED
- Shut off system piezo sounders
- Turn off appropriate zone relay output (ACM-8RF)
- Turn off supervisory relay
- Turn off all remote annunciator general supervisory alarm LEDs
- Turn off all remote annunciator zone supervisory alarm LEDs

Note that for any zone programmed for Supervisory auto-resettable, the Reset switch does not need to be pressed to clear the zone (supervisory condition).

4.3.5 Trouble Condition Response

The control panel will perform the following upon detection of one or more trouble conditions:

- Blink the FACP trouble LED (1 second On, 1 second Off)
- Blink the Zone trouble LED if trouble condition is on the zone (1 second On, 1 second Off)
- Blink all annunciator general system trouble LEDs
- Blink all affected zone trouble LEDs on all system annunciators
- Activate trouble relay
- Store the trouble conditions in the Last Event/History File
- Sound system piezo sounders at a rate of 1 second On, 1 second Off

Note that when AC Brownout occurs, the AC LED is turned off and the Trouble LED blinks. Activation of the Trouble relay is dependent on AC Loss Delay programming.

4.3.6 Trouble Condition Restoral

The control panel performs the following upon restoral of all trouble conditions:

- Shut off the trouble LED
- Shut off the zone trouble LED(s)
- Shut off the piezo sounder
- Deactivate the FACP trouble relay
- Turn on the AC power LED if the trouble was loss of AC power
- Turn off the system general trouble LED on all system annunciators if all trouble conditions are cleared
- Turn off all affected zone trouble LEDs on all system annunciators

CHAPTER 5 *Servicing*

5.1 Walktest Mode

The MS-2410B provides the capability to perform a walktest of the system without triggering the ACM-8RF zone relays, the system annunciators or the alarm output relay. Walktest Mode allows for testing of the 10 zones (initiating device circuits). An audible or silent walktest may be performed.

For an audible walktest, the first initiating device activated on a zone will cause the Notification Appliance Circuits to turn on for four seconds. Subsequent device activations on the same zone will cause the Notification Appliance Circuits to turn on for one second. Any smoke detectors that are activated will be reset. Zonal faults (open circuits) will cause the NAC to remain on steadily. Prior to entering Walktest Mode, check to be certain that all system faults have been cleared.

Note that trouble relays will be activated while the control panel is in Walktest Mode. Placing the control panel into Walktest Mode will only be possible if the system has no active alarms.

The keypad is enabled, to allow switching from Normal Mode to any other mode, by inserting the Security Key into connector J4 on the MS-2410B main circuit board.

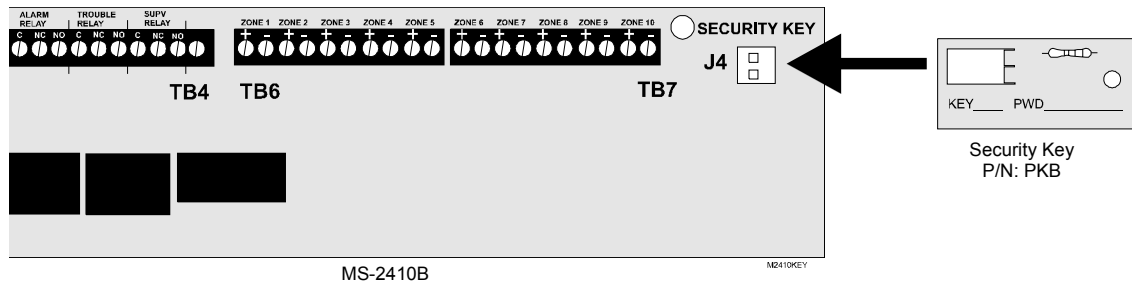

FIGURE 5-1: Security Key - Walktest Mode

Insertion of the Security Key alters the functions of the keypad. Insert the supplied programming keys function label C to view the new key functions. Keys labeled 1 through 4 may now be used for entering a numerical password. Walktest Mode is entered by keying in the Walktest Mode password (**1231233**) and pressing the **Enter** key. If an incorrect key is pressed, wait 10 seconds and then reenter the proper password before pressing the **Enter** key.

A pause of up to 10 seconds is allowed between each key press while entering the password. After pressing the **Enter** key, the control panel will be in Walktest Mode with the keypad key functions configured for this mode. The System Trouble LED and AC Power LED will blink at a rate of ¼ second On and ¼ second Off and the trouble relay will activate. A pause of up to 30 minutes is now allowed between each key press and device activation while in Walktest Mode. Delays longer than 30 minutes will cause the control panel to exit Walktest Mode. The Security Key must be removed and then reinserted in order to reenter Walktest Mode or to enter any other mode.

Once in Walktest Mode, the control panel will immediately:

- Flash the Trouble LED and AC Power LED
- Activate the trouble relay
- Turn on the Notification Appliance Circuits for four seconds for the first alarm on a zone if an audible walktest is performed. Subsequent alarms will sound for one second. Troubles cause the NACs to remain on. For a silent walktest, all NAC outputs remain off
- Disable the alarm relay
- Display all alarm conditions as they occur

Last Event/History Mode

- Display all zone troubles as they occur
- Display all system troubles as they occur

All zone alarm LEDs that turned on during Walktest remain on until the Reset key is pressed. Note that disabled zones will not respond during the Walktest. The LED blink rate for zones 9 and 10, when activated in Walktest, will be at a faster rate than the other zone LEDs.

A zone may be disabled while in Walktest Mode. Should a faulty device require repair, the zone may be disabled while the repair is performed. This allows the user to return the system to Normal Mode, enabling all other zones. This also prevents triggering of a false alarm.

To return the control panel to Normal Mode, remove the Security Key from connector J4 on the MS-2410B main circuit board. Remove the programming key function label and reinsert the Normal Mode label C.

The control panel will automatically revert back to Normal Mode if no system activity has occurred for 30 minutes. This would include pressing any keys or activity on any zone. To enter any other mode of operation, the Security Key must be removed and then reinserted.

During an audible walktest, if a device remains latched in alarm (such as a Pull Station that is not reset after activation), subsequent testing of devices on the same zone will not trigger the NACs. Be certain to reset or clear each device after testing.



CAUTION: The Security Key must be removed from connector J4, upon completion of programming functions, to ensure proper operation of the control panel.

5.2 Last Event/History Mode

The last event which occurred at the FACP is stored in a History File for future recall. Only the most recent event may be called up from memory.

The keypad is enabled, to allow switching from Normal Mode to any other mode, by inserting the Security Key into connector J4 on the MS-2410B main circuit board.

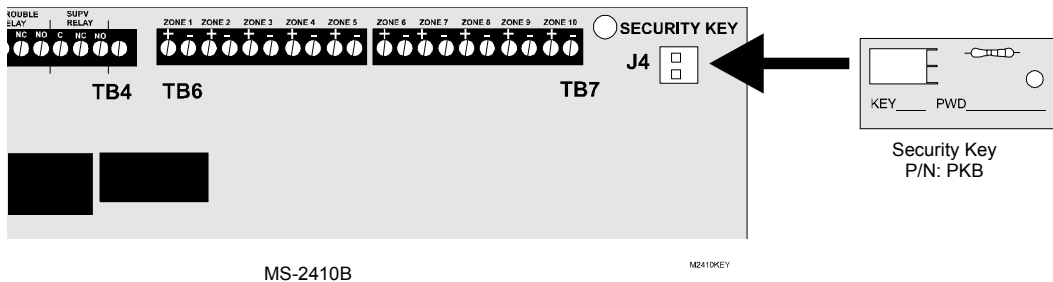

FIGURE 5-2: Security Key - Last Event/History Mode

Insertion of the Security Key alters the functions of the keypad. Insert the programming key function label C to view the new key functions. Keys labeled 1 through 4 may now be used for entering a numerical password. Last Event/History Mode is entered by keying in the password (**1231231**) and pressing the **Enter** key. If an incorrect key is pressed, wait 10 seconds and then reenter the proper password before pressing the **Enter** key.

Lamp Test

A pause of up to 10 seconds is allowed between each key press while entering the password. After pressing the **Enter** key, the control panel will be in Last Event/History Mode, which may be used to troubleshoot the system in the event conditions on the FACP have changed since the last panel activation. Table 5-1 lists possible panel activations and the LEDs which will be on for each in Last Event/History Mode.

TABLE 5-1: History Mode

Latest Panel Activation	LEDs Illuminated
Zone Alarm	Zone Alarm LED & System Alarm LED
Zone Supervisory	Zone Supervisory LED & System Supervisory LED
Zone Trouble	Zone Trouble LED & System Trouble LED
AC Power Loss or Brownout	AC Power LED
Notification Appliance Circuits Silenced by Silence Switch	Signal Silence LED
Ground Fault	Ground Fault LED
Zone Disabled	Zone Trouble LED & Zone Disabled LED
Remote Annunciator Trouble	Annunciator Trouble LED
Notification Appliance Circuit Fault	NAC Fault LED & System Trouble LED
Reverse Polarity Module	System Trouble LED

To return the control panel to Normal Mode, remove the Security Key from connector J4 on the MS-2410B main circuit board. Remove the programming keys function label and reinsert the Normal Mode label C.

The control panel will automatically revert back to Normal Mode after 2 minutes in Last Event/History Mode. To enter any other mode of operation, the Security Key must be removed and then reinserted.



CAUTION: The Security Key must be removed from connector J4, upon completion of programming functions, to ensure proper operation of the control panel.

5.3 Lamp Test

To perform a Lamp Test, press and hold the **Reset/Lamp Test** key for more than two seconds. All panel LEDs will turn on and the piezo sounder will activate.

CHAPTER 6 *Power Supply Calculations*

6.1 Overview

This section contains instructions and tables for calculating power supply currents in alarm and standby conditions. This is a four-step process, consisting of the following:

1. Calculating the total amount of AC branch circuit current required to operate the system
2. Calculating the power supply load current for non-fire and fire alarm conditions and calculating the secondary (battery) load
3. Calculating the size of batteries required to support the system if an AC power loss occurs
4. Selecting the proper batteries for your system

6.2 Calculating the AC Branch Circuit

The control panel requires connection to a separate, dedicated AC branch circuit, which must be labeled **FIRE ALARM**. This branch circuit must connect to the line side of the main power feed of the protected premises. No other non-fire alarm equipment may be powered from the fire alarm branch circuit. The branch circuit wire must run continuously, without any disconnect devices, from the power source to the control panel. Overcurrent protection for this circuit must comply with Article 760 of the National Electrical Codes as well as local codes. Use 14 AWG (2.00 mm²) wire with 600 volt insulation for this branch circuit.

Use Table 6-1 , to determine the total amount of current, in AC amperes (A), that must be supplied to the system.

TABLE 6-1: 120 VAC Branch Circuit Requirements

Device Type	Number of Devices		Current Draw (AC amps)	=	Total Current per Device
MS-2410B(E)	1	X	2.30	=	2.30
FCPS-24F(E)	[]	X	2.00	=	
	[]	X	[]	=	
Sum Column for AC Branch Current Required				=	

6.3 Calculating the System Current Draw

6.3.1 Overview

The control panel must be able to power all internal and external devices continuously during the non-fire alarm condition. To calculate the non-fire alarm load on the system power supply when primary power is applied, use Calculation Column 1 in Table 6-3 on page 53. The control panel must support a larger load current during a fire alarm condition. To calculate the fire alarm load on the power supply, use Calculation Column 2 in Table 6-3 on page 53. The secondary power source (batteries) must be able to power the system during a primary power loss. To calculate the non-fire alarm load on the secondary power source, use Calculation Column 3 in Table 6-3 on page 53.

When calculating current draw and the battery size, note the following:

- ‘Primary’ refers to the main power source for the control panel
- ‘Secondary’ refers to the control panel’s backup batteries
- All currents are given in amperes (A). Table 6-2 shows how to convert milliamperes and microamperes to full amperes.

TABLE 6-2: Converting to Full Amperes

To convert...	Multiply	Example
Milliamperes (mA) to amperes (A)	mA x 0.001	3 mA x 0.001 = 0.003A
Microamperes (µA) to amperes (A)	µA x 0.000001	300 µA x 0.000001 = 0.0003 A

6.3.2 How to Use Table 6-3 on page 53 to Calculate System Current Draw

Use Table 6-3 on page 53 to calculate current draws as follows:

1. Enter the quantity of devices in all three columns
2. Enter the current draw where required. Refer to the Fire-Lite Device Compatibility Document for compatible devices and their current draw
3. Calculate the current draws for each in all columns
4. Sum the total current for each column
5. Copy the totals from Column 2 and Column 3 to Table 6-4 on page 54

Following are the types of current that can be entered into Table 6-3 on page 53:

- ✓ **Calculation Column 1** - The primary supply current load that the control panel must support during a non-fire alarm condition, with AC power applied.
- ✓ **Calculation Column 2** - The primary supply current load that the control panel must support during a fire alarm condition, with AC power applied.
- ✓ **Calculation Column 3** - The standby current drawn from the batteries in a non-fire alarm condition during a loss of AC power.

Calculating the System Current Draw

Table 6-3 contains three columns for calculating current draws. For each column, calculate the current and enter the total (in amperes) in the bottom row. When finished, copy the totals from Calculation Column 2 and Calculation Column 3 to Table 6-4 on page 54.

TABLE 6-3: System Current Draw Calculations

Device Type	Calculation Column 1 Primary Supply, Non-Fire Alarm Current (amps)			Calculation Column 2 Primary Supply, Fire Alarm Current (amps)			Calculation Column 3 Secondary, Non-Fire Alarm Current (amps)		
	Qty	X[current draw]=	Total	Qty	X [current draw] =	Total	Qty	X[current draw]=	Total
Main Circuit Board	1	X[0.138]=	0.138	1	X[0.245]=	0.245 ¹	1	X[0.138]=	0.138
RTB Remote Trouble Buzzer	[]	X[0.020]=		[]	X[0.020]=			X[0.020]=	
LED-10IM	[]	X[0.017]=		[]	X[0.017]=			X[0.017]=	
LED-10 Annunciator	[]	X[0.023]=		[]	X[0.040] ² =			X[0.024]=	
Misc. Annunciators	[]	X[] ⁶ =		[]	X[] =			X[] =	
4XTMF Module	[]	X[0.005]=		[]	X[0.011] ³ =			X[0.005]=	
411 Digital Comm.	[]	X[0.078]=		[]	X[0.126] ⁴ =			X[0.078]=	
411UD Digital Comm.	[]	X[0.100]=		[]	X[0.170] ⁵ =			X[0.100]=	
2-wire Detector Heads	[]	X[] ⁶ =		[]	X[] =			X[] =	
2-wire Detector Heads	[]	X[] ⁶ =		[]	X[] =			X[] =	
4-wire Detector Heads	[]	X[] ⁶ =		[]	X[] =			X[] =	
4-wire Detector Heads	[]	X[] ⁶ =		[]	X[] =			X[] =	
Power Supervision Relays ⁷	[]	X[0.025]=		[]	X[0.025]=			X[0.025]=	
NAC #1 ⁸				[]	X[] =				
NAC #2				[]	X[] =				
Current Draw from TB2 (nonalarm ⁹)		[] =			[] =			[] =	
Sum each column¹⁰ for totals		Primary Non-Alarm =			Primary Alarm =			Secondary Alarm =	

1. The current shown represents one zone on the main circuit board in alarm. For all ten zones in alarm, the current draw increases to 0.590 amps.
2. The current shown represents all ten zones in alarm. One zone in alarm will draw 0.028 amps.
3. If using the Reverse Polarity Alarm output, add 0.005 amps; if using the Reverse Polarity Trouble output, add another 0.005 amps.
4. 240 mA may be possible with all input channels shorted, 411 communicating, Programmer connected and Lamp Test active
5. 300 mA may be possible with all input channels shorted, 411UD communicating, Programmer connected and Lamp Test active
6. Refer to the Device Compatibility Document for standby current.
7. Must use compatible listed Power Supervision Relay.
8. Current limitation of Terminal TB3 circuits is 1.25 amps per NAC expandable to 2.5 amps.
9. The total standby current must include both the resettable (TB2 Terminals 3 & 4) and nonresettable (TB2 Terminals 1 & 2) power. Caution must be taken to ensure that current drawn from these outputs during alarm does not exceed maximum ratings specified. Current limitations of TB2, Terminals 1 & 2 = 0.500 amps, filtered, 24 VDC +/-5%, 120 Hz ripple @ 10 mV_{RMS}, nonresettable power and TB2, Terminals 3 & 4 = 0.300 amps, filtered, 24 VDC +/-5%, 120 Hz ripple @ 10mV_{RMS}, resettable power.
10. Total current draw listed above cannot exceed 3.6 amps with only standard transformer installed or 6.6 amps with both the standard and optional transformers installed.

6.4 Calculating the Battery Size

Use Table 6-4 to calculate the total Standby and Alarm load in ampere hours (AH). This total load determines the battery size (in AH), required to support the control panel under the loss of AC power. Complete Table 6-4 as follows:

1. Enter the totals from Table 6-3 on page 53, Calculation Columns 2 and 3 where shown
2. Enter the NFPA Standby and Alarm times (refer to ‘NFPA Requirements’ below)
3. Calculate the ampere hours for Standby and Alarm, then sum the Standby and Alarm ampere hours
4. Multiply the sum by the derating factor of 1.2 to calculate the proper battery size (in AH)
5. Write the ampere hour requirements on the Protected Premises label located inside the cabinet door

TABLE 6-4: Total Secondary Power Requirements at 24 VDC

Secondary Standby Load (total from Table 6-3 Calculation Column 3) []	Required Standby Time (24 or 60 hours) X[]	= AH
Primary Alarm Load (total from Table 6-3 Calculation Column 2) []	Required Alarm Time (for 5 min., enter 0.084, for 10 min., enter 0.168) X[]	= AH
Sum of Standby and Alarm Ampere Hours		= AH
Multiply by the Derating Factor		X 1.2
Battery Size, Total Ampere Hours Required		= AH

6.4.1 NFPA Battery Requirements

- NFPA 72 Local and Remote Station Fire Alarm Systems require 24 hours of standby power followed by 5 minutes in alarm
- NFPA 72 Central Station, Auxiliary and Remote Station require 60 hours of standby followed by 5 minutes in alarm. Batteries installed in a system powered by a generator need to provide at least 4 hours of standby power
- NFPA requires 24 hours of standby plus 15 minutes activation for audio systems. The total ampere hours required cannot exceed 18 AH with an internal charger

6.4.2 Selecting and Locating Batteries

Select batteries that meet or exceed the total ampere hours calculated in Table 6-4. The control panel can charge batteries in the 7 AH to 18 AH range. The control panel cabinet is capable of housing batteries up to 12 AH. Batteries larger than 12 AH require the BB-17F or other UL listed external battery cabinet.

Appendix A *NFPA Requirements*

NFPA Signaling Systems for Central Station Service (Protected Premises Unit)

The following figure illustrates an example of Central Station/Remote Station Reporting using a 411UD Digital Alarm Communicator Transmitter. The 411 may also be used for this purpose. The relay contacts from the MS-2410B may be used to trip any dialer UL listed for Central Station/Remote Station Services.

Note: Reference the 411 or 411UD Manual for additional information

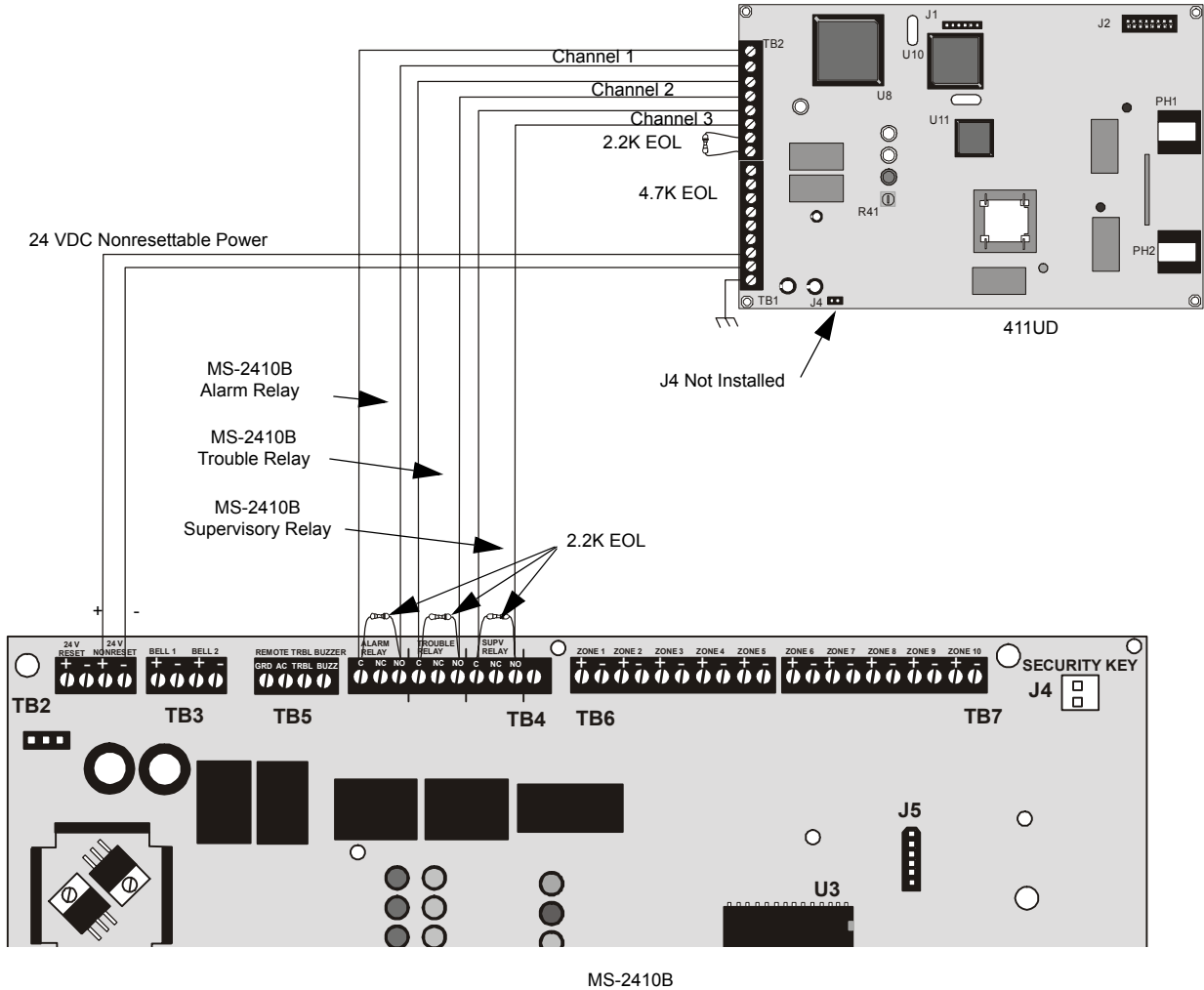

TABLE A-1: 411UD Connections to MS-2410B

	411UD	MS-2410B
Alarm	1	1
	2	3
Trouble	3	4
	4	6
Supervisory	5	7
	6	9

Appendix B *Wire Requirements*

Connecting external system accessories to the MS-2410B main circuits must be carefully considered to ensure proper operation. It is important to use the correct type of wire, wire gauge and wire run length per each MS-2410B circuit. Reference the chart below to specify wire requirements and limitations for each MS-2410B.

TABLE B-1: Wire Requirements

CIRCUIT TYPE	CIRCUIT FUNCTION	WIRE TYPE AND LIMITATIONS	RECOMMENDED MAX. DISTANCE Feet (meters)	WIRE GAUGE
Initiating Device Circuit	Connects to Initiating Devices	Untwisted, unshielded wire (Do not exceed 100 ohms)	10,000 (3,000 m) 8,000 (2,400 m) 4,875 (1,480 m) 3,225 (975 m)	12 AWG (3.25 mm ²) Belden 9583 WPW999 14 AWG (2.00 mm ²) Belden 9581 WPW995 16 AWG (1.30 mm ²) Belden 9575 WPW991 18 AWG (0.75 mm ²) Belden 9574 WPW975
EIA-485 LED-10IM Inter- face Module	Connects to annunciator modules and relay module	Twisted, shielded pair with a characteristic impedance of 120 ohms	6,000 (1,800 m)	18 AWG (0.75 mm ²)
24 VDC resettable, nonresettable	Connects to annunciators and other accessories	No more than 1.2 volt drop allowed from supply source to end of any branch	Distance limitation set by 1.2 volt maxi- mum line drop	12 AWG (3.25 mm ²) - 18 AWG (0.75 mm ²)

Appendix C *Slide-in Labels*

The spare slide-in labels on the following pages are provided for the MS-2410B keypad and display panel in the event that the original labels are lost or damaged. The labels may be cut from the manual or photo-copied and then carefully cut out and inserted into the proper location, as indicated in Figure C-1. Labels slide into pockets which are accessible through the top of the keypad and display panel.

During the Normal Mode of operation, insert the labels into the keypad and display panel as follows (refer to Figure C-1):

- Label A Normal Mode label into pocket designated Label A
- Label B Normal Mode label into pocket designated Label B
- Label C Normal Mode label into pocket designated Label C

During Program Mode of operation, insert the labels into the keypad and display panel as follows:

- Label A Program Mode label into pocket designated Label A
- Label C Program Mode label into pocket designated Label C

A set of labels is provided for Normal Mode operation and another set is provided for Program Mode operation. Be sure to insert the proper set of labels for the corresponding mode of operation. Figure C-1 illustrates Normal Mode labels installed in the keypad and display panel. Note that extra 'A' Normal Mode slide-in labels are also supplied blank. Type the desired zone or location information directly on the line inscribed on the labels to insure correct positioning of the typed information in the label windows. Information should be typed before cutting the labels from the page.

FIGURE C-1:Keypad and Display Panel Slide-in Labels

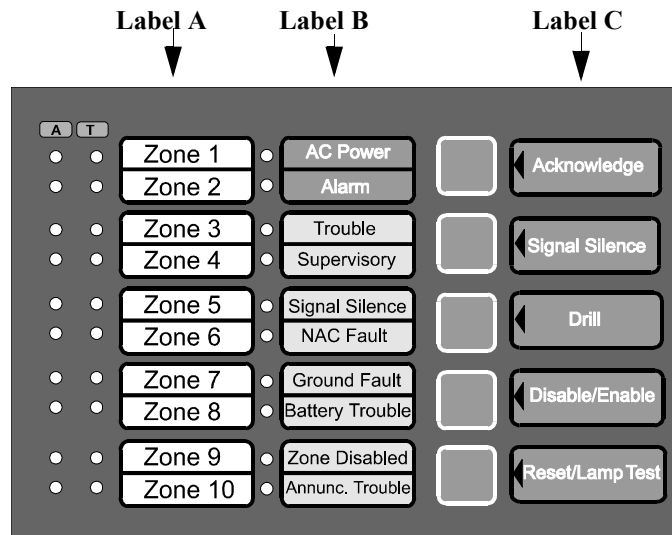

Slide-in Labels

Slide-in Labels

Normal Mode Slide-in Labels

Type appropriate information on blank Label A prior to cutting from page. Typed entries must be centered and typed on the lines provided to ensure proper positioning in the membrane windows. Be certain to cut all labels directly on dotted lines to ensure proper fit.

A	T	Label A - Normal Mode	Label B - Normal Mode	Label C - Normal Mode
			AC Power Alarm	Acknowledge
			Trouble Supervisory	Signal Silence
			Signal Silence	Drill
			NAC Fault	
			Ground Fault	Disable/Enable
			Battery Trouble	
			Zone Disabled	Reset/Lamp Test
			Annunc. Trouble	

Program Mode Slide-in Labels

F	O	Label A - Program Mode	Label C - Program Mode
		Auto Silence	
		Silenceable NACs	
		Walk Test	↑ 1
		Supervisory Alarm	
		Alarm Verification	↓ 2
		AC Loss Delay	
		Module Supervision	Toggle Option 3
		Annunc. Addresses	
		Trouble Reminder	
		Silence Inhibit	Enter 4

Slide-in Labels

Index

Numerics

4-Wire Smoke Detector Power 24
4XTMF Transmitter Module 14, 29

A

ABS-8RF 28
AC
 see also Primary Power 22
AC Loss Delay 40
AC Power 11
AC voltage sense 9
Acknowledge 43
 Normal Mode
 Acknowledge 43
ACM-8RF Relay Module 9, 14, 15, 27
 Address 28
 Switch Settings 28
ACM-8RF Remote Relay Module 28
Alarm Verification 9, 39
Annunciator Maximum Monitored Address 40
Auto-silence 38
 Options 38
Auto-Silence Notification Appliance Circuits 9

B

Backbox 19
backbox 9
Battery 11, 14
 Charger 13
 Rating 13
 Charger Capacity 11
 Charging Circuit 11
 see also Power, Secondary 22
 Warning 22

Battery Cabinet 15
BB-17F Battery Cabinet 11, 13

C

Cabinet 14
Canadian Supervisory 37, 39
Circuit
 Input 23
Circuits 13
 Input 13
 Output 13
Class B 23, 24
Controls 12
conventional input devices 9
cursor 34, 36, 37

D

Default Programming Mode 42
Dimensions
 Cabinet 18
Disable/Enable 44
DP-2410BC

see also Dress Panel

Dress Panel 9, 14

Drill 43

E

Earth Ground 22
EIA-485 9, 13, 14, 15, 27

F

FACP 9
 see also Fire Alarm Control Panel
FCPS-24F(E) 27
FCPS-24F(E) Remote Power Supply 16
 NAC 16
Fire Alarm 23
Fire Alarm Control Panel 9
Fire Alarm Response 46
Fire Alarm Restoral 46
Form-C Relay 25
Form-C relay 9, 13
Four-wire Smoke Detector Power 11
 Current 11
Four-wire Smoke Detectors 23
four-wire smoke detectors 9

G

General Alarm Zone 11
general alarm zone 9
General Fire Alarm 23

I

IDC 9, 23
 see also Initiating Device Circuit
Indicators 12
Initiating Device Circuit 9, 11, 23
 Alarm Current 11
 Class B 11, 23
 End-of-Line Resistor 11
 Maximum Loop Resistance 11
 Operating Voltage 11
 Short Circuit Current 11
 Standby Current 11

Initiating Device Circuits 15

Installation 17

K

Keypad 10, 12
keypad 9, 32
Keys 12
 Acknowledge 12
 Disable/Enable 12
 Drill 12
 Reset/Lamp Test 12
 Signal Silence 12
 slide-in-labels 12

Knockout Locations
 Cabinet 18

L

Lamp Test 44
LED 12, 44
 AC Power 44
 Alarm 12, 44
 Annunciator Trouble 12, 45
 Battery Trouble 12, 45
 Ground Fault 12
 NAC Fault 12
 Signal Silence 12
 Supervisory 12, 45
 Trouble 12, 44
 Zone Alarm 45
 Zone Disabled 12, 45
 Zone Fire Alarm 12
 Zone Supervisory 45
 Zone Supervisory Alarm 12
 Zone Trouble 12, 45

LED-10 Series Annunciator 15
LED-10 Series Remote Annunciator 14, 27

LED-10 Series Remote Annunciators 9

LED-10IM 14, 15, 27

LED-10IM Interface Module 10

LED-10IM Option Module 9

M

Main Circuit Board 13
Module Supervision Enabled 40
Mounting 17
 Semi-flush 17
 Surface 17
MS-2410B 11, 24

N

NAC 9, 16
Nonresettable 24 VDC Power 12
 Current 12
Nonresettable Power 13, 24
Normal Mode 32
Notification Appliance Circuit 9, 10, 11, 13, 16, 24
 Class B 11, 24
 Current 11
 Current Limit 11
 End-of-Line Resistor 11
 Maximum Signaling Current 11
 Operating Voltage 11

O

Operating Instructions 43
Operation 45
Optional Modules 26
Output Circuit 24

P

panel keypad 9
password 32
Piezo Sounder 13, 26

Index

- Alarm 13
- Alarm Verification 13
- Supervisory 13
- Trouble 13
- pointer 34
- Power
 - Operating 22
 - Primary 22
 - Secondary 22
- Power-limited 25
- Primary Power
 - MS-2410B 22
 - Wire Size 22
- Product Description 9
- Product Features 9
- Program Feature
 - AC Loss Delay 40
 - Alarm Verification 39
 - Annunciator Maximum Monitored Address 40
 - Auto-silence 38
 - Module Supervision Enabled 40
 - Silence Inhibit 41
 - Silenceable NAC 38
 - Supervisory Alarm 38
 - Table 37
 - Trouble Reminder 41
 - Walktest 38
- Program Feature Selection 33
- Program Features 37
- Program Mode 32
- Programming 30
 - Features and Options 31
 - Features and Options Table 31
- Programming Functions 33
- Programming Options 33, 37
- pull stations 9
- R**
- Relay 10, 11, 13, 25, 28
 - Alarm 9
 - contact rating 11, 13, 25
 - Supervisory 9
 - Trouble 9
- Remote Trouble Buzzer 9, 12, 13, 15, 26
 - Current 12
 - Operating Voltage 12
- Reset/Lamp Test 44
- Resettable Power 13, 23
- S**
- Security Key 32, 33
- Servicing 48
- Signal Silence 43
- Silence Inhibit 41
- Silence Inhibit Notification Appliance Circuits 9

- Silenceable NAC 38
- Smoke Detector Identifier A 11
- Smoke Zone 11
- smoke zone 9
- Supervisory Alarm 23
- Supervisory Alarm Zone 11
- supervisory alarm zone 9
- Supervisory Alarms 38
 - Auto-resettable 38
 - Canadian Supervisory 39
 - Latching 38
- Supervisory Condition Response 46
- Supervisory Restoral Response 47
- Switch Functions 30
 - Normal Mode 43
 - Disable/Enable 44
 - Drill 43
 - Reset/Lamp Test 44
 - Signal Silence 43
 - Program Mode 30
 - Slide-in Labels 30
- system power 9
- T**
- Toggle Option 35, 36
- Transformer 14
- Trouble Condition Response 47
- Trouble Condition Restoral 47
- Trouble Reminder 9, 41
- two-wire smoke detectors 9
- W**
- Walktest 9, 38
- Walktest Mode 48
- waterflow devices 9
- Wiring
 - Power-limited 25
- X**
- XRM-24 Transformer 12, 14, 24

Limited Warranty

The manufacturer warrants its products to be free from defects in materials and workmanship for eighteen (18) months from the date of manufacture, under normal use and service. Products are date-stamped at time of manufacture. The sole and exclusive obligation of the manufacturer is to repair or replace, at its option, free of charge for parts and labor, any part which is defective in materials or workmanship under normal use and service. For products not under the manufacturer's date-stamp control, the warranty is eighteen (18) months from date of original purchase by the manufacturer's distributor unless the installation instructions or catalog sets forth a shorter period, in which case the shorter period shall apply. This warranty is void if the product is altered, repaired, or serviced by anyone other than the manufacturer or its authorized distributors, or if there is a failure to maintain the products and systems in which they operate in a proper and workable manner. In case of defect, secure a Return Material Authorization form from our customer service department. Return product, transportation prepaid, to the manufacturer.

This writing constitutes the only warranty made by this manufacturer with respect to its products. The manufacturer does not represent that its products will prevent any loss by fire or otherwise, or that its products will in all cases provide the protection for which they are installed or intended. Buyer acknowledges that the manufacturer is not an insurer and assumes no risk for loss or damages or the cost of any inconvenience, transportation, damage, misuse, abuse, accident, or similar incident.

THE MANUFACTURER GIVES NO WARRANTY, EXPRESSED OR IMPLIED, OF MERCHANTABILITY, FITNESS FOR ANY PARTICULAR PURPOSE, OR OTHERWISE WHICH EXTEND BEYOND THE DESCRIPTION ON THE FACE HEREOF. UNDER NO CIRCUMSTANCES SHALL THE MANUFACTURER BE LIABLE FOR ANY LOSS OF OR DAMAGE TO PROPERTY, DIRECT, INCIDENTAL, OR CONSEQUENTIAL, ARISING OUT OF THE USE OF, OR INABILITY TO USE THE MANUFACTURER'S PRODUCTS. FURTHERMORE, THE MANUFACTURER SHALL NOT BE LIABLE FOR ANY PERSONAL INJURY OR DEATH WHICH MAY ARISE IN THE COURSE OF, OR AS A RESULT OF, PERSONAL, COMMERCIAL, OR INDUSTRIAL USE OF ITS PRODUCTS.

This warranty replaces all previous warranties and is the only warranty made by the manufacturer. No increase or alteration, written or verbal, of the obligation of this warranty is authorized.



World Headquarters

One Fire-Lite Place, Northford, CT 06472-1653 USA

203-484-7161 • Fax 203-484-7118

www.firelite.com

ISO 9001
CERTIFIED
ENGINEERING & MANUFACTURING