

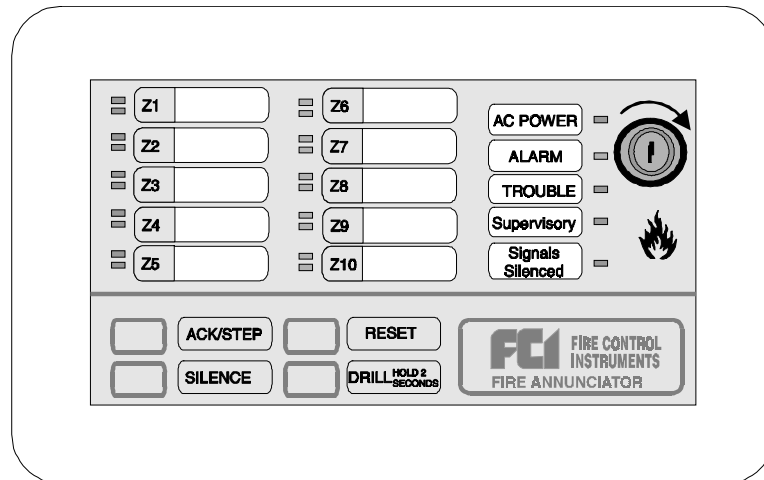

Fire Control Instruments, Inc.
301 2nd Avenue
Waltham, MA 02451-1133, USA
Phone (781) 487-0088
FAX: (781) 370-4132

The RZA-10 Series Remote Fire Annunciators

*for use with the
FC-10C
Fire Alarm Control/Communicator*



Document # 51063
9/15/98 Revision: **A**
P/N 51063:A ECN 98-422

Contents

Section One: RZA-10 Series Annunciators	4
Features	4
Figure 1-1: Component Summary	5
Figure 1-2: Wiring to Terminals	6
SW1 DIP Switch Settings	7
Figure 1-3: SW1 DIP Switch Settings Example	7
Figure 1-4: SW2 DIP Switch Settings Example	8
Table 1-1: RZA-10 Series Annunciator Addressing	9
Figure 1-5: Typical Configuration	9
LED Indicators and Piezo Sounder	10
Switch Functions for RZA-10 Only	11
Section Two: RZA-10 Series Annunciators Mounting	13
Figure 2-1: RZA-10 Series Hardware	13
Figure 2-2: RZA-10 Series Backboxes	13
Figure 2-3: RZA-10 Series Semi-flush Mounting	14
Figure 2-4: RZA-10 Series Surface Mounting	15
Section Three: RZA-10 Series Electrical Connections	16
Figure 3-1: Power Connection	16
Figure 3-2: LED-10IM Installation	17
Figure 3-3: EIA-485 Connection	18
Figure 3-4: Wiring FACP to RZA-10 Series	19
Section Four: EIA-485 Shield Terminations	20
When the EIA-485 Shield is not in Conduit	20
When the EIA-485 Shield is in Full Conduit	21
Spare Slide-In Labels for RZA-10 Series Annunciators	23

Section One: RZA-10 Series Annunciators

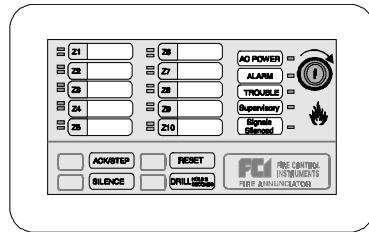

RZA-10

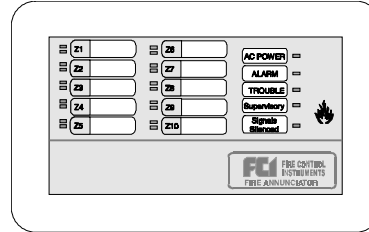

RZA-10L and RZA-10LS2

The RZA-10 Series Annunciators consist of the RZA-10, RZA-10L and RZA-10LS2. They are compact, attractive LED-type fire annunciators designed for use with the FC-10C Fire Alarm Control Communicator. The RZA-10L and RZA-10LS2 are models which do not have function switches or a key-switch. The RZA-10LS2 provides zone 9 and 10 alarm LEDs that are yellow for supervisory functions.

The RZA-10 Series Annunciators are capable of displaying independent zone fire alarm, process monitor alarm, trouble and supervisory status. They also provide system status LEDs to display Power, Alarm, Trouble, Supervisory and Signals Silenced conditions. The RZA-10 model is also capable of performing system acknowledge, silence, drill and reset remotely.

Communication between the control panel and the RZA-10 Series Annunciators is accomplished over a two-wire serial interface employing the EIA-485 communication standard. Up to 32 RZA-10 Series Annunciators may be connected to the two-wire EIA-485 circuit. The annunciators may be powered from the host FACP or remote, UL listed, filtered, regulated power supplies.

Features - all models

- Zone Alarm and Trouble LEDs.
- System Status LEDs for Power (green), Alarm (red), Trouble (yellow), Supervisory (yellow) and Signals Silenced (yellow).
- Local piezo sounder with alarm and trouble resound.
- Distinctly different flash rates for LEDs and piezo sounder distinguish system status:
 - ✓ fire alarm = 1 second on and 1 second off
 - ✓ process monitor alarm = 1/4 second on and 1/4 second off
 - ✓ supervisory alarm = 1/2 second on and 1/2 second off
- EIA-485 connects to control panel terminal port (requires LED-10IM module).
- Plug-in terminal blocks for ease of installation and service.
- DIP switch controls transmit/receive mode.
- Up to 32 RZA-10 Series Annunciators per FC-10C.
- Mounting options:
 - ✓ Surface mount in three gang electrical box P/N: SBB-3
 - ✓ Semi-flush mount in three-gang electrical box P/N: 10103 (2 3/16" min. depth)
 - ✓ Can be located up to 6,000 feet (1,800 m) from the panel using 18 AWG wire
- Slide-in labels for custom labeling.
- Simple programming at FC-10C panel enables communications to RZA-10 Series annunciators.

RZA-10 only:

- Function switches for:
 - ✓ Acknowledge ✓ Signal Silence ✓ Drill ✓ System Reset
- Enable/Disable key-switch for function switches.
- DIP switches control local functions such as piezo enable/disable, function switches and key-switch enable/disable.

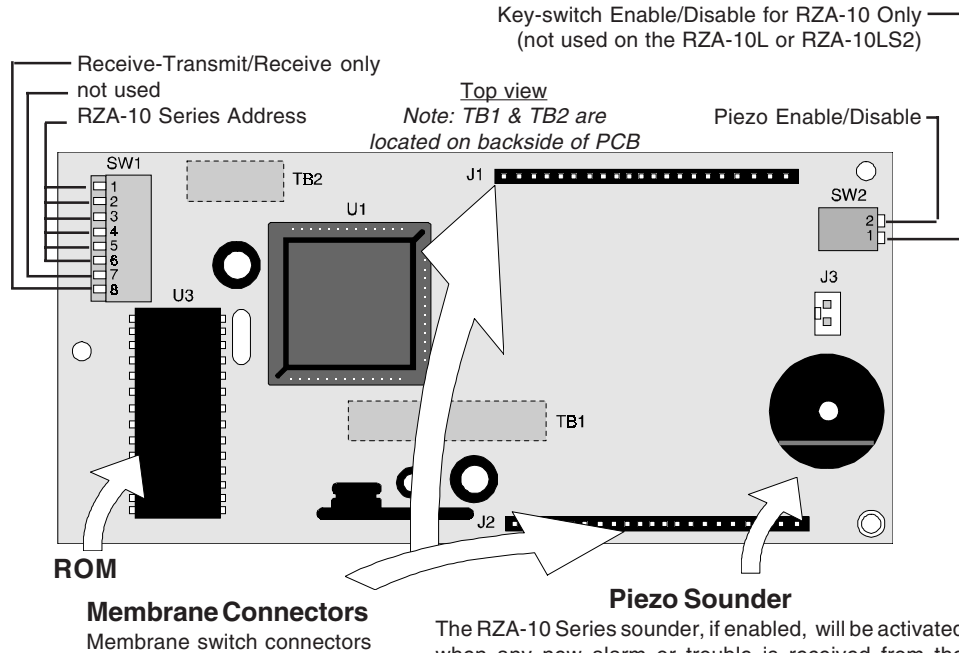

The RZA-10 Series sounder, if enabled, will be activated when any new alarm or trouble is received from the panel. It is silenced by pressing an ACKNOWLEDGE or SILENCE switch. Piezo must not be disabled without approval of LAHJ (Local Authority Having Jurisdiction).

Figure 1-1: Component Summary

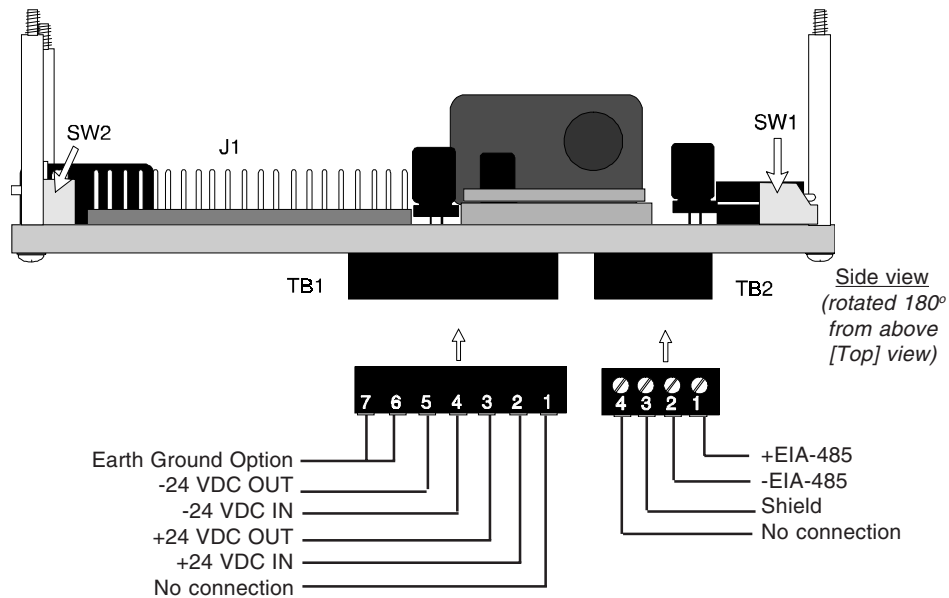

Note: These connections must be power-limited and the +24 volt nominal power (18 VDC to 26 VDC) must be filtered.

Current Consumption @ 24 VDC nominal (filtered)	
Normal/Standby (no activity):	23 mA
Trouble Condition:	31 mA
Alarm:	28 mA (1 zone in alarm)
	40 mA (all 10 zones in alarm)
AC Fail:	24 mA

Figure 1-2: Wiring to Terminals

SW1 DIP Switch Settings

The OPEN position on SW1 is the OFF state. Refer to Figure 1-3 for an explanation of DIP switch positions. SW1 switch settings are as follows:

1 through 6 - RZA-10 Series annunciator address switches.

The first six switches are used to set the address of the annunciator. The OFF (OPEN) up position equals a binary 1 and the ON down position equals a binary 0. Refer to Table 1-1 for information on setting these switches for specific addresses. Each RZA-10 Series annunciator connected to the EIA-485 communication bus must have a unique address.

7 - Not used

8 - ON = Receive/Transmit, OFF (OPEN) = Receive Only

Switch 8 set to ON position enables Receive/Transmit mode for the RZA-10 Series annunciator. This allows the annunciator to receive and display system status information and to transmit supervision status. It also allows the RZA-10 model to transmit system control data such as Acknowledge/Step, Reset, Signal Silence and Drill. Switch 8 set to the OFF position enables Receive Only mode which allows the annunciator to receive and display system status information but prevents supervision status from being transmitted back to the FACP. It also prevents function switch operation on the RZA-10 model. To ensure annunciator supervision for all RZA-10 Series annunciators and function switch capability for the RZA-10 model, each annunciator connected to the EIA-485 communication bus must have a unique address and should be set to enable Receive/Transmit Mode.

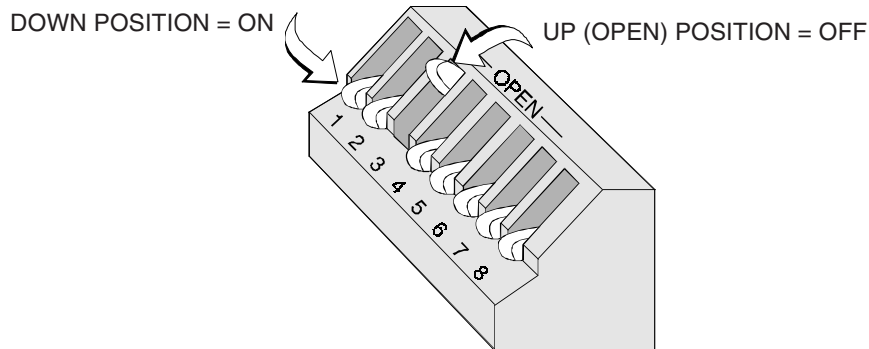

NOTE - SW1 DIP switch settings as illustrated in Figure 1-3 are as follows:

- 1) DIP switches 1 - 6: Address 08 (see Table 1-1).
- 2) DIP switch 7: Not used.
- 3) DIP switch 8: ON = Receive/Transmit

Figure 1-3: SW1 DIP Switch Settings Example

SW2 DIP Switch Settings

SW2 switch settings are as follows:

1 - RZA-10 Only (not used on RZA-10L and RZA-10LS2)

ON = Key-switch Enable, OFF = Key-switch Disable.

Switch 1 set to the ON position enables the key-switch operation. The key-switch may now be used to enable RZA-10 model membrane (control) switches, allowing remote switch functions, or lockout the switches, preventing remote switch functions. Switch 1 set to the OFF position disables the key-switch operation. Refer to Operation Section for key-switch function description.

2 - ON = Piezo sounder enabled, OFF = Piezo sounder disabled.

CAUTION: Piezo sounder must not be disabled without prior approval of the Local Authority Having Jurisdiction.

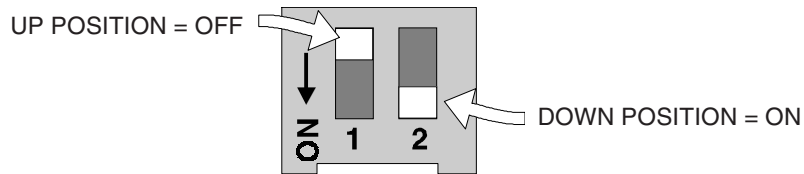

Figure 1-4: SW2 DIP Switch Settings Example

RZA-10 Series Addressing

SW1 DIP switches 1 through 6 are used for addressing the RZA-10 Series annunciators. *Each device connected to the EIA-485 communication bus must have a unique address.* This allows specific data to be transmitted between the FACP and that device and for individual supervision of each annunciator by the FACP. Switch settings and the corresponding addresses are shown in Table 1-1. (Address '00' is invalid).

Note: 1 = Switch in the UP (OPEN) position.

0 = Switch in the DOWN position.

Example:

ADDRESS	SWITCH SETTINGS					
	1	2	3	4	5	6
08	0	0	1	0	0	0

Addressing Switches

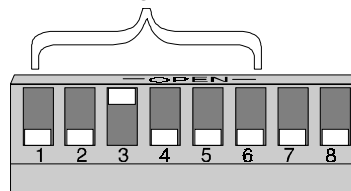

ADDRESS	SWITCH SETTINGS						ADDRESS	SWITCH SETTINGS					
	1	2	3	4	5	6		1	2	3	4	5	6
INVALID	0	0	0	0	0	0	17	0	1	0	0	0	1
01	0	0	0	0	0	1	18	0	1	0	0	1	0
02	0	0	0	0	1	0	19	0	1	0	0	1	1
03	0	0	0	0	1	1	20	0	1	0	1	0	0
04	0	0	0	1	0	0	21	0	1	0	1	0	1
05	0	0	0	1	0	1	22	0	1	0	1	1	0
06	0	0	0	1	1	0	23	0	1	0	1	1	1
07	0	0	0	1	1	1	24	0	1	1	0	0	0
08	0	0	1	0	0	0	25	0	1	1	0	0	1
09	0	0	1	0	0	1	26	0	1	1	0	1	0
10	0	0	1	0	1	0	27	0	1	1	0	1	1
11	0	0	1	0	1	1	28	0	1	1	1	0	0
12	0	0	1	1	0	0	29	0	1	1	1	0	1
13	0	0	1	1	0	1	30	0	1	1	1	1	0
14	0	0	1	1	1	0	31	0	1	1	1	1	1
15	0	0	1	1	1	1	32	1	0	0	0	0	0
16	0	1	0	0	0	0							

Table 1-1: RZA-10 Series Annunciator Addressing

Typical Configuration

The RZA-10 Series annunciators indicate the status of the FC-10C, display zone status and require no programming. In addition, the RZA-10 model offers multiple annunciator locations with the capability of remote Acknowledge, Signal Silence, Drill and Reset functions.

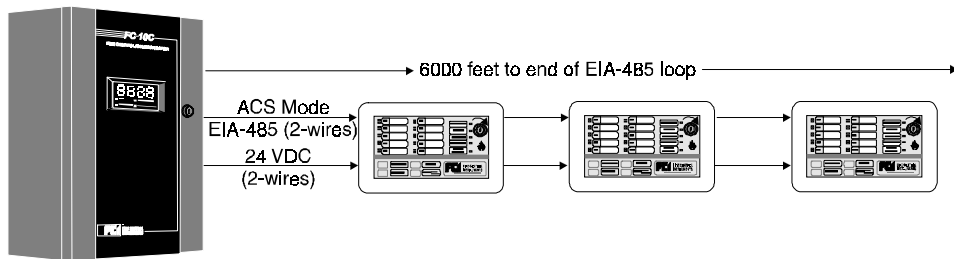

NOTES:

- 1) **EIA-485:** Maximum of 6,000 feet (1,800 m) total cable length from FACP to RZA-10 Series annunciators. Circuit is power-limited.
- 2) Up to 32 RZA-10 Series annunciators may be used on the EIA-485 circuit. The FC-10C can power a maximum of seven annunciators. If additional annunciators are connected, a UL listed power supply may be used to supply additional power, the power supply must be regulated, power-limited and UL listed for Fire Protective Signaling Systems. (Power supplies used for this purpose must have their negative terminals commoned together).
- 3) Between each annunciator are four wires: A twisted-shielded pair for data communications and a pair for 24 VDC power.
- 4) A mix of RZA-10 Series annunciators can be connected to the same EIA-485 circuit.

Figure 1-5: Typical Configuration

LED Indicators and Piezo Sounder

The RZA-10 Series annunciators provide LEDs which indicate the system and zone status of its associated FC-10C fire alarm control/communicator.

AC Power

This is a green LED which illuminates if AC power is applied to the host FACP. The green LED will turn off if AC power to the host FACP is lost.

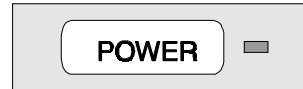

Alarm

This is a red LED that flashes (1 second on, 1 second off) when one or more fire alarms occur. The piezo sounder turns on steady for alarm. The LED illuminates steadily and the piezo silences when an Acknowledge or Silence switch is pressed. The Alarm LED turns off when the Reset switch is pressed after the alarm condition has been cleared.



Trouble

This is a yellow LED that flashes (1 second on, 1 second off) when one or more trouble conditions occur. The piezo sounder pulses (1 second on, 1 second off). The LED turns on steady and the piezo silences when an Acknowledge or Silence switch is pressed. The LED turns off when all trouble conditions are cleared. This LED will also illuminate if the microprocessor watchdog circuit within the annunciator is activated.

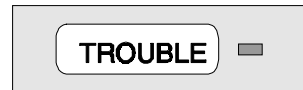

Supervisory

This is a yellow LED that flashes (½ second on, ½ second off) when one or more supervisory conditions occur, such as a sprinkler valve tamper condition. The piezo sounder pulses (½ second on, ½ second off). The LED illuminates steadily and the piezo silences when an Acknowledge or Silence switch is pressed. The Supervisory LED turns off when a Reset switch is pressed after clearing the supervisory condition.

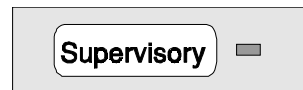

RZA-10 and RZA-10L Only

Zone Alarm - Zones 1 through 10

This is a red LED that flashes when a fire alarm, supervisory alarm or process monitoring alarm occurs on the corresponding zone. The LED flashes at a 1 second on/1 second off rate for a fire alarm condition, a ½ second on/½ second off rate for a supervisory alarm and a ¼ second on/¼ second off rate for a process monitoring alarm. The piezo sounder will pulse at a rate corresponding to the flashing LED. The LED illuminates steadily and the piezo silences when an Acknowledge or Silence switch is pressed. The LED turns off when the fire alarm, process monitoring alarm or supervisory alarm is cleared on the corresponding zone and the Reset switch is pressed.

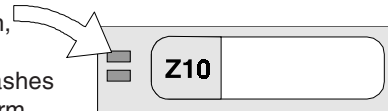

Note: Be certain to use customized slide-in label to identify the zone function, since the red LED will flash for a variety of conditions as programmed in the FACP. Refer to the FC-10C Manual P/N 51057 for details.

RZA-10LS2 Only

Zone Alarm - Zones 1 through 8

The red LED for Zones 1 through 8 on the RZA-10LS2 operate the same as on the RZA-10 and RZA-10L. Refer to the previous section.



Zone Alarm - Zones 9 and 10

This is a yellow LED on Zones 9 and 10 of the RZA-10LS2 only. These two zones should be used to annunciate supervisory alarms only (primarily designed for Canadian Supervisory Service). Approval from the Local Authority Having Jurisdiction is required in order to annunciate fire alarms or process monitor alarms on these zones. The LED flashes at a 1/2 second on/1/2 second off rate for a supervisory alarm. The piezo sounder will pulse at a rate corresponding to the flashing LED. The LED illuminates steadily and the piezo silences when an Acknowledge or Silence switch is pressed. The LED turns off when the supervisory alarm is cleared on the corresponding zone and the Reset switch is pressed.

Zone Trouble - Zones 1 through 10 (All RZA-10 Series)

This is a yellow LED that flashes when a zone trouble condition occurs on the corresponding zone. The LED flashes at a 1 second on/1 second off rate for a zone trouble condition. The piezo sounder will pulse at a rate corresponding to the flashing LED. The LED illuminates steadily and the piezo silences when the Acknowledge or Silence switch is pressed. The LED turns off when all trouble conditions on the corresponding zone are cleared.

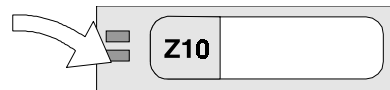

Switch Functions for RZA-10 Model Only

Key-switch

The key-switch is used to enable and disable the operation of the membrane (control) switches if switch 1 on DIP switch SW2 has been placed to the ON position.

To enable the Acknowledge, Silence, Drill and Reset function switches, insert a standard control panel key into the key-switch located at the top right corner of the RZA-10. Make certain the key is inserted completely before attempting to turn it.

Turn the key clockwise until it stops. Leave the key inserted while pressing the function switches. When finished with the function switches, turn key-switch counterclockwise to disable function switches.

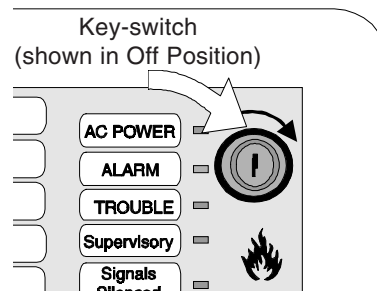

Note: The key-switch should normally be in the disabled position (fully counterclockwise), with the key removed and access to the key restricted to authorized personnel only. Do not leave the key unattended in the RZA-10.

Acknowledge

When the Acknowledge switch is pressed and released, the RZA-10 sends an Acknowledge command to the control panel. Pressing the Acknowledge switch silences the local piezo sounder, the sounders located in all other system annunciators and the sounder located on the Fire Alarm Control Panel's main circuit board. It will also change all flashing system LEDs to steady on. Only one press is necessary regardless of the number of new alarms, troubles or supervisory signals. An acknowledge message is also sent to the printer and the history files in the FC-10C.



Silence

When the Silence switch is pressed and released, the RZA-10 sends a Signal Silence command to the control panel. The Silence switch performs the same functions as the Acknowledge switch. In addition, if an alarm exists, it turns off all *silenceable* NAC outputs only and causes the FACP ALARM SILENCE LED and the RZA-10 SIGNAL SILENCE LED to turn on. It also sends an ALARM SILENCED message to the printer and the history file within the FC-10C. A subsequent new alarm will resound the appropriate Notification Appliance Circuits (NACs) and local sounders.



Drill: Hold 2 Sec.

When the Drill switch is pressed and held for at least two seconds (time required to prevent accidental activations), the RZA-10 will transmit a drill command to the control panel. This command causes the FACP to turn on all main panel NAC outputs. In the event that the system was previously silenced, the drill command will also turn off the ALARM SILENCE LED. (The Silence switch operates on *silenceable* NAC outputs only).



Reset

When the System Reset switch is pressed and released, the RZA-10 sends a Reset command to the control panel. This will turn off all Notification Appliance Circuits, temporarily turns off resettable power to 4-wire detectors, and sends a "SYSTEM RESET" message to the FACP display, printer and FC-10C history files. It also turns on all system LEDs, piezo sounders and FACP LED display segments as long as the Reset switch is held (lamp test). Any alarm or trouble that exists after a Reset will resound the system.



Section Two: Mounting RZA-10 Series Annunciators

RZA-10 Series Annunciator Preparation

The RZA-10 Series can be surface mounted in a three-gang electrical box, P/N SBB-3 or semi-flush mounted in a three-gang electrical box, P/N 10103 or equivalent, with a minimum depth of 2 3/16". Select and remove the appropriate knockout(s), pull the necessary wires through the knockouts and mount the three-gang box in or on the wall depending on the type of installation desired. *Be certain that power is not applied to the wiring during the installation procedure.*

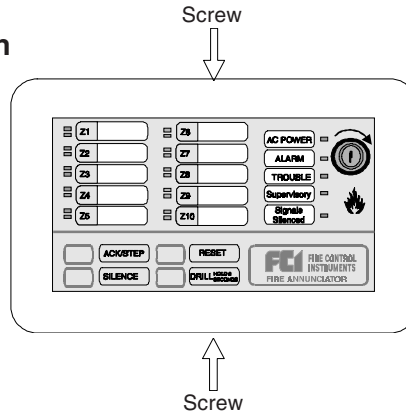

Note: To ensure static protection, all enclosures, including the RZA-10 Series electrical box, must be connected to earth ground! Never use the shield of the communications wiring for static protection.

To mount the RZA-10 Series Annunciator in the electrical box, the trim ring must first be removed. The trim ring is held in place by two screws inserted through the top and bottom edge as illustrated above. Removal of the trim ring will expose a metal flange with mounting holes.

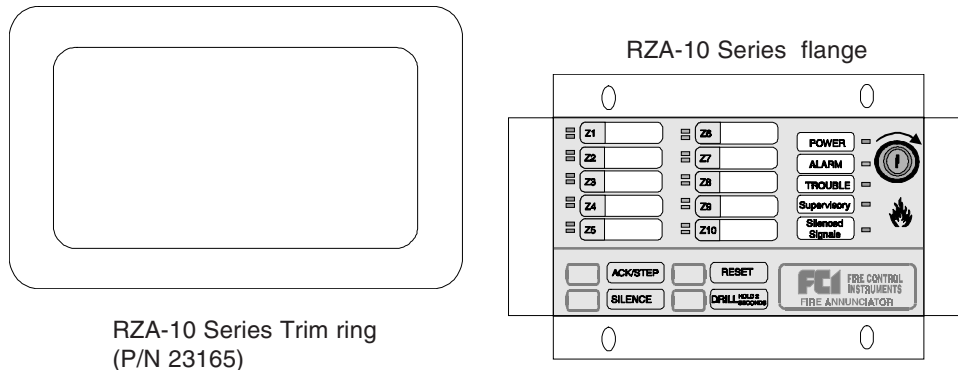

Figure 2-1: RZA-10 Series Hardware

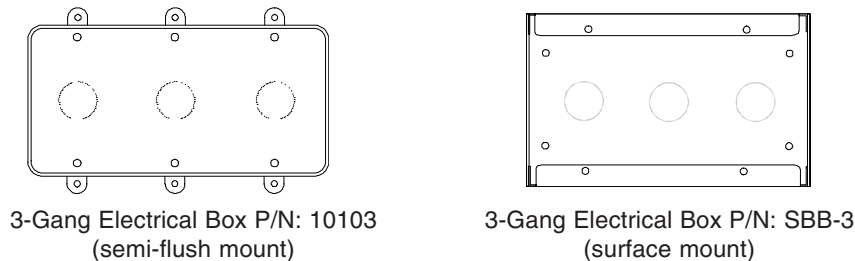

Figure 2-2: RZA-10 Series Backboxes

Semi-flush Mount Backbox

Remove the plug-in terminal blocks from the RZA-10 Series circuit board. Connect the EIA-485 and power wiring into the terminal block positions illustrated in Figures 3-1 and 3-3. Plug the terminal blocks back into the TB1 and TB2 connectors on the back of the annunciator circuit board.

Set DIP switches SW1 and SW2 for the desired options (refer to switch settings in Figures 1-3, 1-4 and Table 1-1).

Mount the RZA-10 Series to the three-gang electrical box using the four mounting holes on the annunciator flange and the four screws provided for this purpose. Replace the trim ring and secure with the two screws which were previously removed. Adjust the plastic trim ring to the surface of the wall before tightening the screws. *Do not over-tighten.*

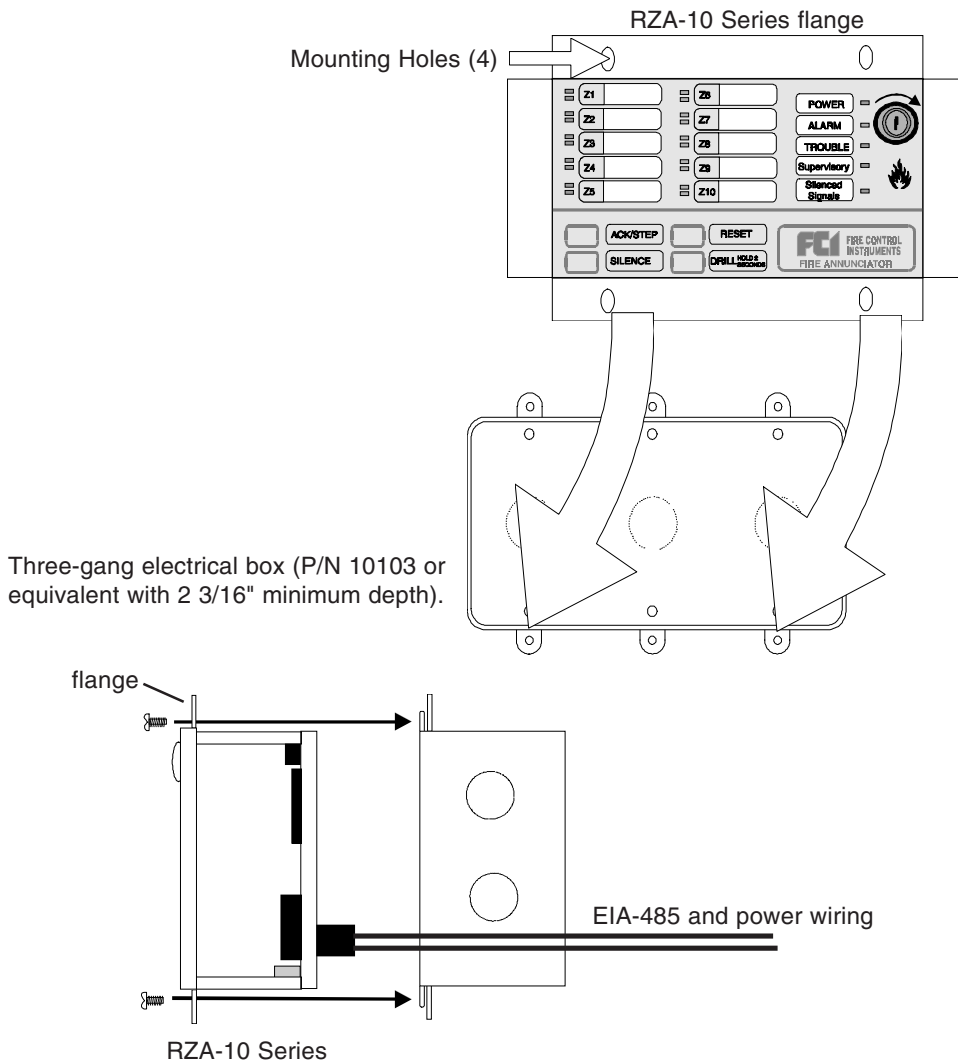

Figure 2-3: Semi-flush Mounting

Surface Mount Backbox

Remove the plug-in terminal blocks from the RZA-10 Series circuit board. Connect the EIA-485 and power wiring into the terminal block positions illustrated in Figures 3-1 and 3-3. Plug the terminal blocks back into the TB1 and TB2 connectors on the back of the annunciator circuit board.

Set DIP switches SW1 and SW2 for the desired options (refer to switch settings in Figures 1-3, 1-4 and Table 1-1).

Mount the RZA-10 Series to a three-gang electrical box using the four mounting holes on the annunciator flange and the four screws provided for this purpose. Replace the trim ring and secure with the two screws which were previously removed. Do not overtighten.

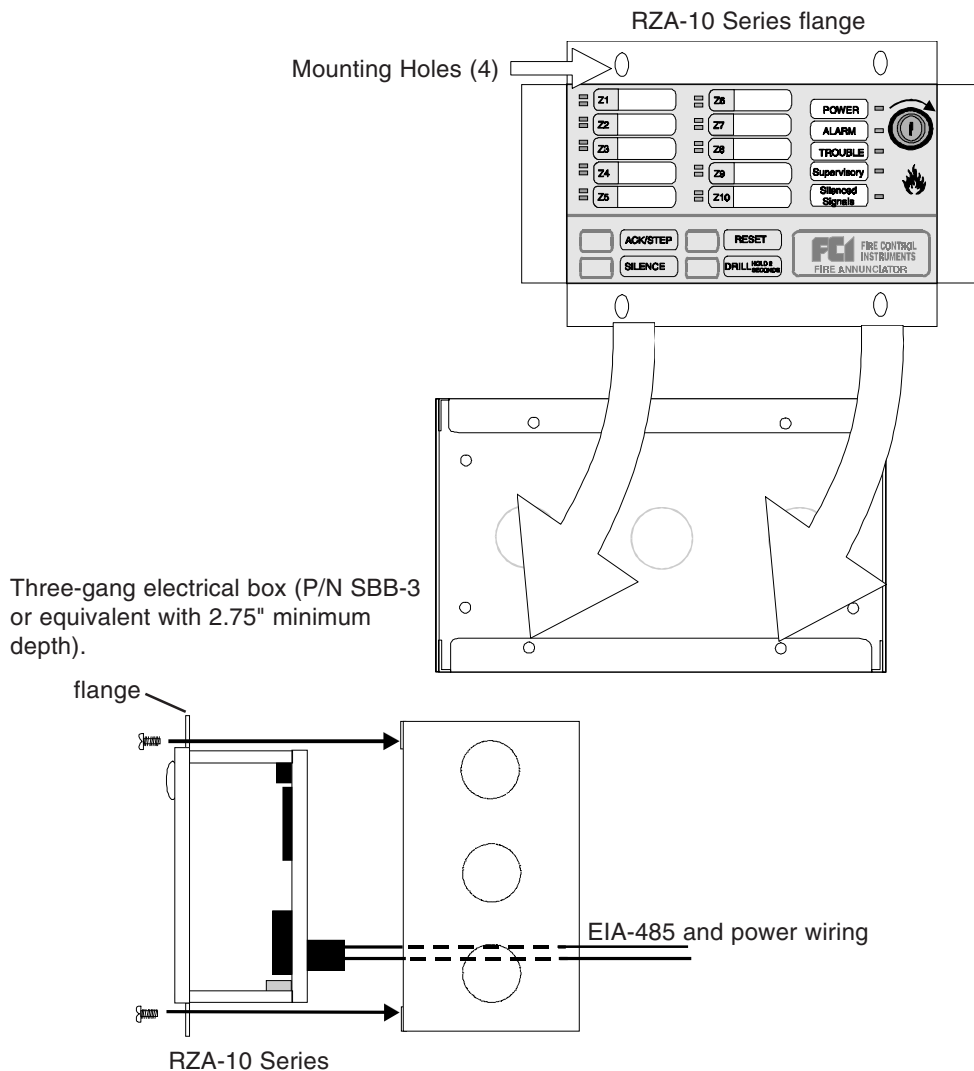
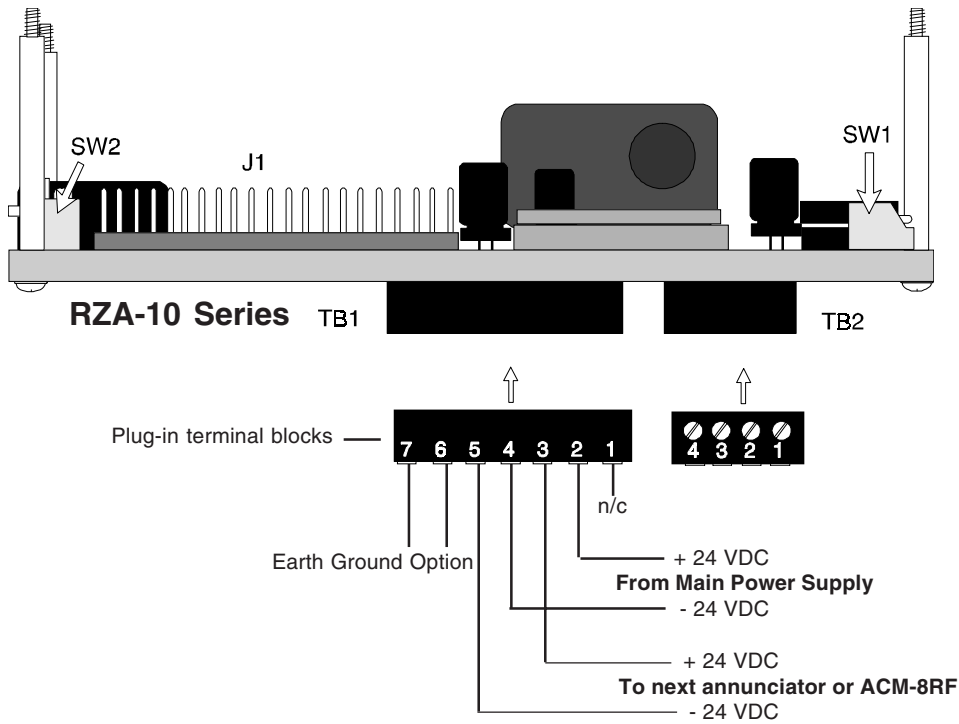

Figure 2-4: Surface Mounting

Section Three: RZA-10 Series Electrical Connections

The RZA-10 Series Annunciators can be powered by the FC-10C power output or from a remote, UL listed, filtered power supply such. The power run to the RZA-10 Series must be power-limited but need not contain a power supervision relay since loss of power is inherently supervised through loss of communication with the annunciator. Maximum RZA-10 Series current draw from the power supply under alarm condition is 28 mA. Maximum current draw from the control panel's secondary power source (batteries) under loss of AC power is 24 mA.



Note: All connections are power-limited and supervised.

Figure 3-1: Power Connection

LED-10IM

The LED-10IM Interface Module provides an EIA-485 port to support the FCI-RZA-10 Series, and the Fire•Lite AFM Series and LDM Series annunciators as well as the ACM-8RF Remote Relay Module and is therefore required when connecting these devices to the FC-10C. The FC-10C supervises EIA-485 wiring for open circuits via the LED-10IM Interface Module. The LED-10IM plugs into connector J6 located in the upper right corner of the FC-10C main circuit board.

Install the two supplied standoffs into the FACP main circuit board. Ensure that the metal standoff is installed in the position indicated in the illustration below. Carefully align the two connectors and press the LED-10IM module securely into place. Make certain the pins are properly aligned to prevent bending or breaking of any pins. It is important that the supplied screw and washer be used to secure the module to the metal standoff. This is necessary in order to help protect against electrical transients.

Note: Refer to the FC-10C Manual Programming Section for information on programming the RZA-10 Series Annunciators into the system.

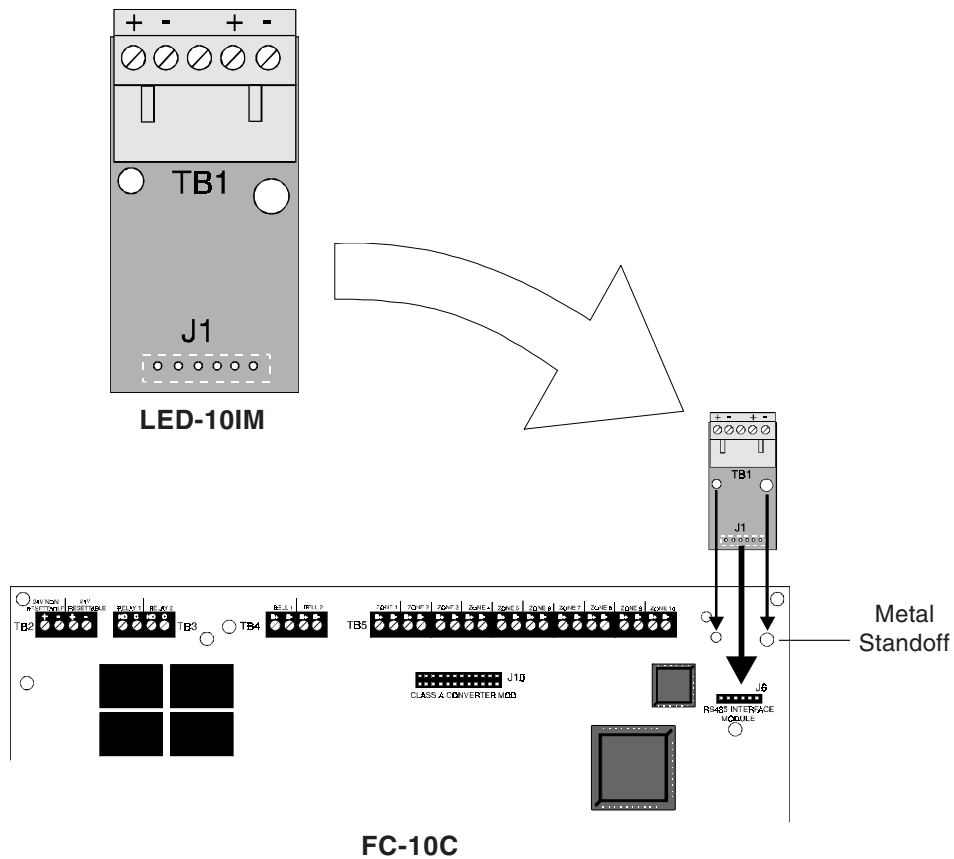
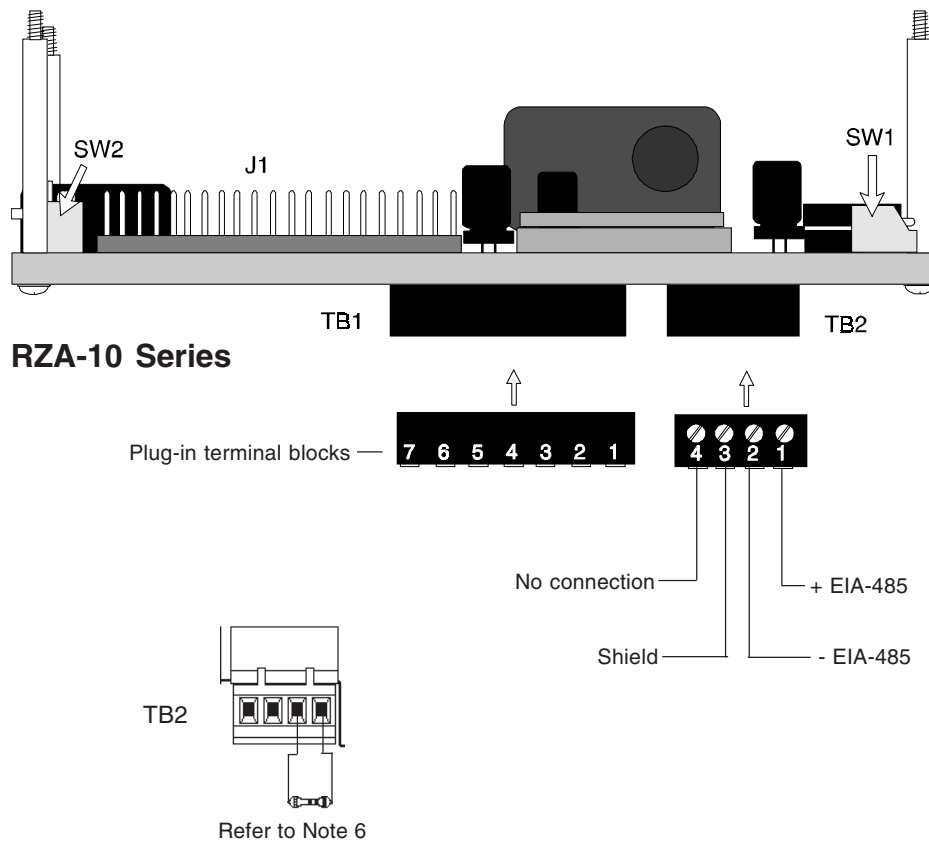

Figure 3-2: LED-10IM Installation



Notes:

- 1) All connections are power-limited and supervised.
- 2) A maximum of 32 RZA-10 Series Annunciators may be connected to this circuit.
- 3) 6,000 feet (1,800 m) maximum distance @ 18 AWG (0.75 mm²) between the panel and annunciators.
- 4) Use overall foil/braided-shield twisted pair cable suitable for EIA-485 applications (refer to Section Four for shield termination information).
- 5) The EIA-485 circuit is rated at 5.5 VDC maximum and 60 mA maximum.
- 6) The RZA-10 Series Annunciators must have the supplied R120 (120 ohm) resistor installed across the EIA-485 terminals on the last or only device connected to the EIA-485 bus as shown. The resistor is required for impedance matching.

Figure 3-3: EIA-485 Connection

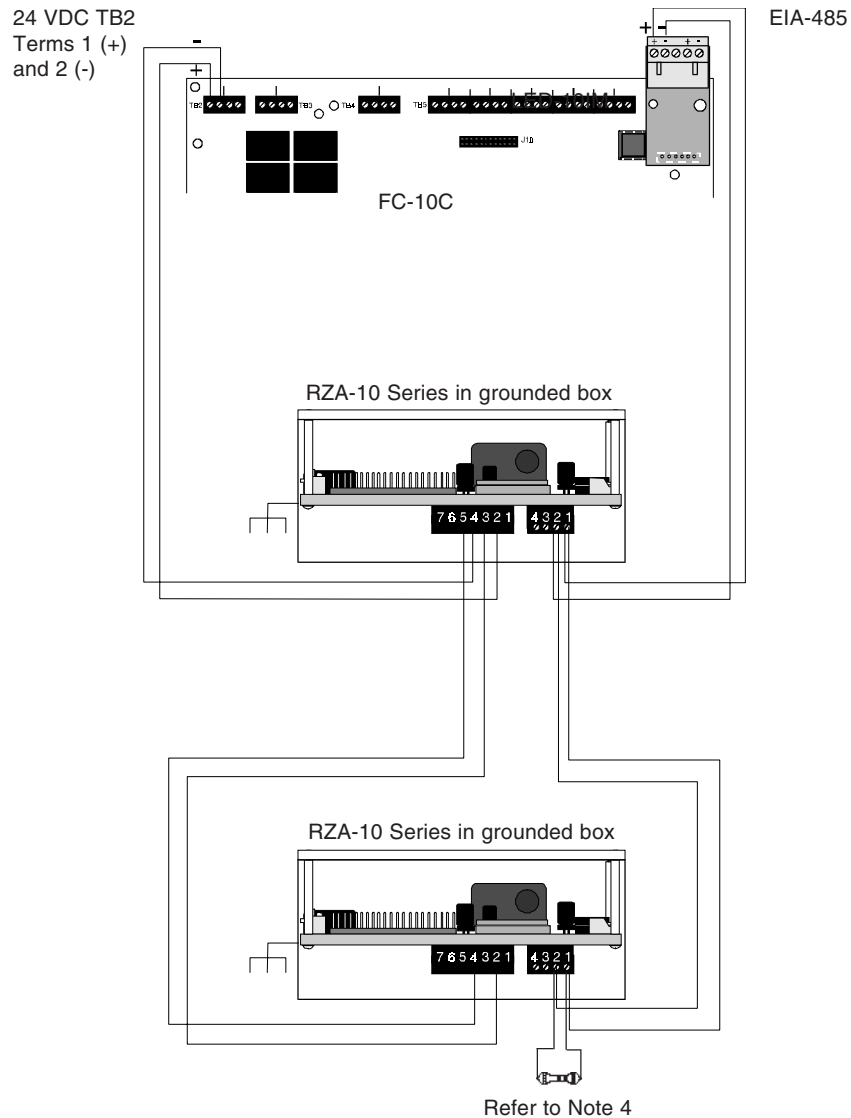

CAUTION! Please be certain to secure the LED-10IM module to the FC-10C and to keep all wiring from mechanically interfering with the LED-10IM.

Note:

- 1) Twisted, shielded wire is recommended for the EIA-485 communications loop.
- 2) Four-conductor, overall shielded wire may be used for the four EIA-485 wires and the two power wires. It is, however, strongly recommended that the power and communication wires be separate whenever possible.
- 3) Refer to Figures 3-1, 3-2 and 3-3 for RZA-10 Series and LED-10IM terminal designations.
- 4) The RZA-10 Series Annunciators must have the supplied R120 (120 ohm) resistor installed across the EIA-485 terminals on the last or only device connected to the EIA-485 bus as shown. The resistor is required for impedance matching.

Figure 3-4: Wiring FACP to RZA-10 Series Annunciator

Section Four: EIA-485 Shield Terminations

The EIA-485 circuit must be wired using a twisted-shielded pair cable having a characteristic impedance of 120 ohms, +/- 20%. Do not run cable adjacent to, or in the same conduit as, 120-volt AC service, noisy electrical circuits that are powering mechanical bells or horns, audio circuits above 25 V_{RMS}, motor control circuits, or SCR power circuits

Note: To ensure static (ESD - electrostatic discharge) protection, all enclosures, including the RZA-10 Series electrical box, must be connected to earth ground! Never use the EIA-485 shield for this purpose. The EIA-485 shield is for radiated noise emission protection (RFI, EMI). Refer to the following figures.

The EIA-485 shield should be terminated as follows:

When the EIA-485 shield is not in conduit: The EIA-485 loop allows the FACP to communicate with the annunciators. The shield for the EIA-485 loop must be connected to earth ground at the FACP but must be left floating (no connection) at the annunciator if it is the first or only device on the EIA-485 loop. If a second annunciator is connected, the shield leaving the first annunciator must be left floating. The shield entering the second annunciator must be connected to the 3-gang box or Earth Ground terminal (TB1-6 & 7) on the second annunciator. If additional annunciators are connected, the shield leaving each enclosure must be left floating and the shield entering each must be connected to the 3-gang box or the Earth Ground Terminal (TB1-6 & 7) on the annunciator.

Connect the drain wire to the outside of the FC-10C cabinet via a BX-type connector.

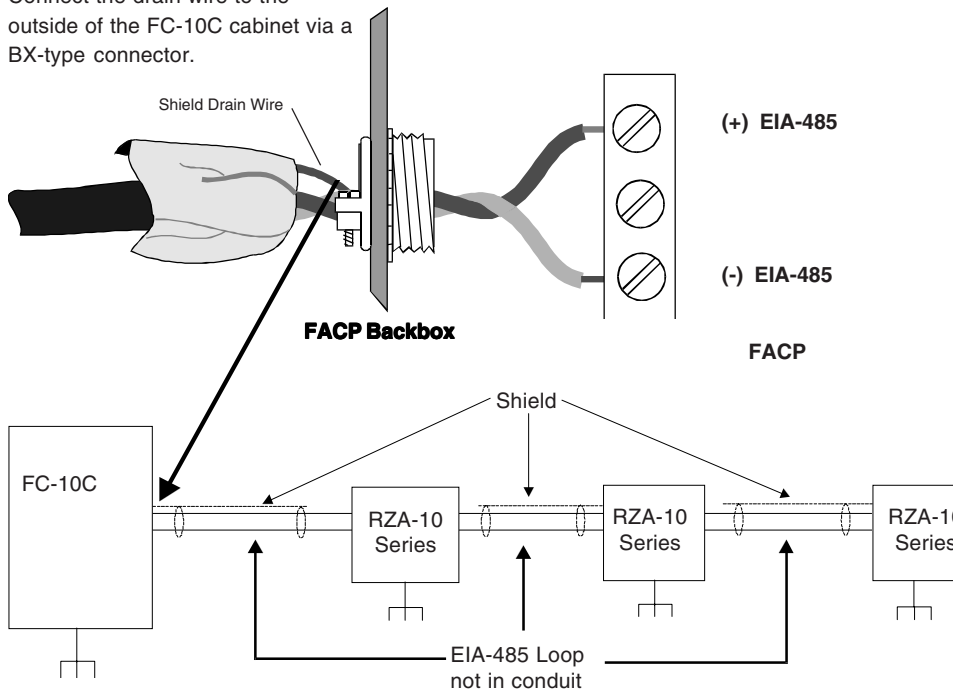

When the EIA-485 shield is in full conduit: The EIA-485 loop allows the FACP to communicate with the annunciator(s). The shield for the EIA-485 loop must be connected to earth ground at the FACP, but must be left floating (no connection) at the annunciator if it is the first or only device on the EIA-485 loop. If a second annunciator is connected, the shield leaving the first annunciator must be left floating. The shield entering the second annunciator must be connected to the Earth Ground Terminal (TB1- 6 & 7) on the second annunciator. If additional annunciators are connected, the shield leaving each annunciator must be left floating and the shield entering the following unit must be connected to the Earth Ground Terminal (TB1 - 6 & 7) on the annunciator.

Caution! Do not allow the floating (no connection) end of the shield to contact the conduit. The floating end should be insulated from earth ground.

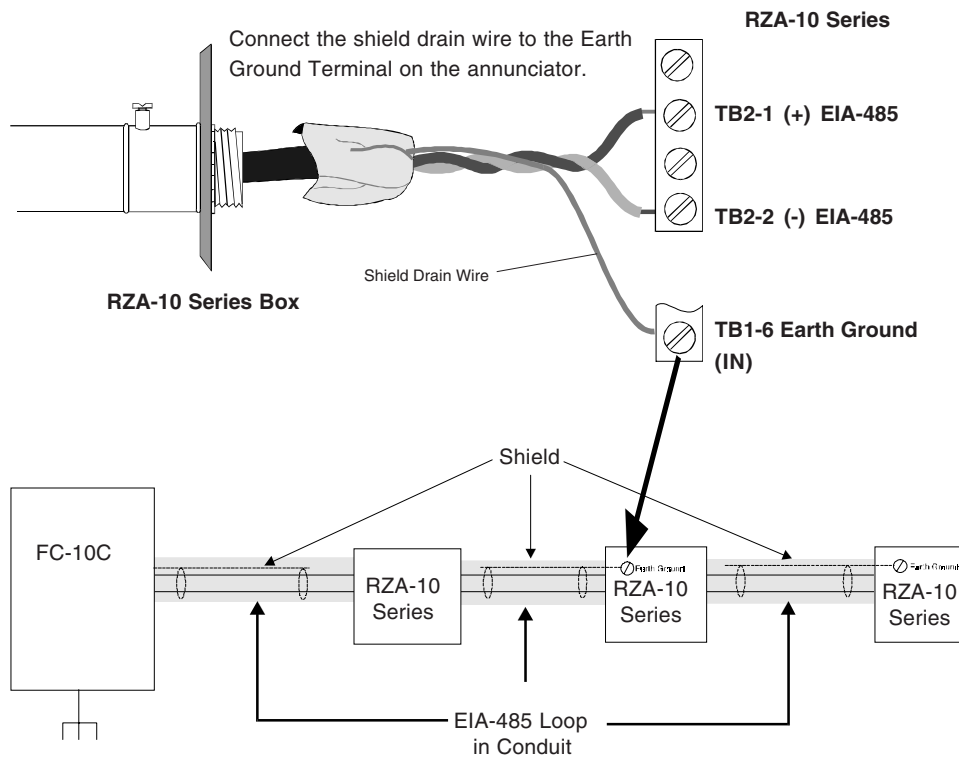

Notes:

- 1) Power-limited 24 VDC regulated power may be run in the same conduit as the EIA-485 wiring.
- 2) Twisted, shielded wire is recommended for the EIA-485 communications loop.
- 3) Each RZA-10 Series Annunciator's electrical backbox is connected to earth ground via the conduit.
- 4) Shield is connected to the FACP cabinet (earth ground) leaving the FACP.

Notes

Slide-In Labels for the RZA-10 Series Annunciators

Slide-in labels for Zones 1-10 are included with the RZA-10 Series Annunciators. In the event that these labels are damaged or lost, remove this page from the manual and type the appropriate information on the labels shown below. Type on the lines provided to ensure centering of information in label windows. Carefully cut out the labels and insert them into the two label slots on the top left side of the annunciator face plate.

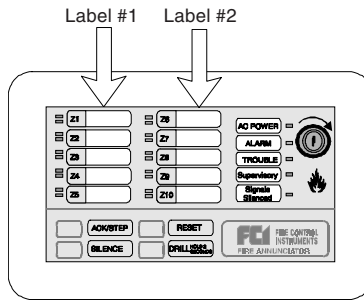

Note: To ensure the best fit, cut directly along the dotted line surrounding each label.

Custom User Label #1	Custom User Label #2

Custom User Label #1	Custom User Label #2

Notes

Notes

Notes

