

The SA500C Fire Control Communicator

Installation, Operation and Programming Manual



Document # 50569	B
3/16/99 Rev:	
P/N 50569:B ECN 99-037	

Installation Precautions - Adherence to the following will aid in problem-free installation with long-term reliability:

WARNING - Several different sources of power can be connected to the fire alarm control panel. Disconnect all sources of power before servicing. Control unit and associated equipment may be damaged by removing and/or inserting cards, modules, or interconnecting cables while the unit is energized. Do not attempt to install, service, or operate this unit until this manual is read and understood.

CAUTION - *System Reacceptance Test after Software Changes:* To ensure proper system operation, this product must be tested in accordance with NFPA 72-1993 Chapter 7 after any programming operation or change in site-specific software. Reacceptance testing is required after any change, addition or deletion of system components, or after any modification, repair or adjustment to system hardware or wiring.

All components, circuits, system operations, or software functions known to be affected by a change must be 100% tested. In addition, to ensure that other operations are not inadvertently affected, at least 10% of initiating devices that are not directly affected by the change, up to a maximum of 50 devices, must also be tested and proper system operation verified.

This system meets NFPA requirements for operation at 0-49° C/32-120° F and at a relative humidity of 85% RH (non-condensing) at 30° C/86° F. However, the useful life of the system's standby batteries and the electronic components may be adversely affected by extreme temperature ranges and humidity. Therefore, it is recommended that this system and its peripherals be installed in an environment with a nominal room temperature of 15-27° C/60-80° F.

Verify that wire sizes are adequate for all initiating and indicating device loops. Most devices cannot tolerate more than a 10% I.R. drop from the specified device voltage.

Like all solid state electronic devices, this system may operate erratically or can be damaged when subjected to lightning induced transients. Although no system is completely immune from lightning transients and interferences, proper grounding will reduce susceptibility. Overhead or outside aerial wiring is not recommended, due to an increased susceptibility to nearby lightning strikes. Consult with the Technical Services Department if any problems are anticipated or encountered.

Disconnect AC power and batteries prior to removing or inserting circuit boards. Failure to do so can damage circuits.

Remove all electronic assemblies prior to any drilling, filing, reaming, or punching of the enclosure. When possible, make all cable entries from the sides or rear. Before making modifications, verify that they will not interfere with battery, transformer, and printed circuit board location.

Do not tighten screw terminals more than 9 in-lbs. Over tightening may damage threads, resulting in reduced terminal contact pressure and difficulty with screw terminal removal.

This system contains static-sensitive components. Always ground yourself with a proper wrist strap before handling any circuits so that static charges are removed from the body. Use static suppressive packaging to protect electronic assemblies removed from the unit.

Follow the instructions in the installation, operating, and programming manuals. These instructions must be followed to avoid damage to the control panel and associated equipment. FACP operation and reliability depend upon proper installation.

Fire Alarm System Limitations

While installing a fire alarm system may make lower insurance rates possible, it is not a substitute for fire insurance!

An automatic fire alarm system - typically made up of smoke detectors, heat detectors, manual pull stations, audible warning devices, and a fire alarm control with remote notification capability can provide early warning of a developing fire. Such a system, however, does not assure protection against property damage or loss of life resulting from a fire.

Any fire alarm system may fail for a variety of reasons:

Smoke detectors may not sense fire where smoke cannot reach the detectors such as in chimneys, in walls, or roofs, or on the other side of closed doors. Smoke detectors also may not sense a fire on another level or floor of a building. A second floor detector, for example, may not sense a first floor or basement fire. Furthermore, all types of smoke detectors - both ionization and photoelectric types, have sensing limitations. No type of smoke detector can sense every kind of fire caused by carelessness and safety hazards like smoking in bed, violent explosions, escaping gas, improper storage of flammable materials, overloaded electrical circuits, children playing with matches, or arson.

IMPORTANT! *Smoke detectors must be installed in the same room as the control panel and in rooms used by the system for the connection of alarm transmission wiring, communications, signaling, and/or power.* If detectors are not so located, a developing fire may damage the alarm system, crippling its ability to report a fire.

Audible warning devices such as bells may not alert people if these devices are located on the other side of closed or partly open doors or are located on another floor of a building.

A fire alarm system will not operate without any electrical power. If AC power fails, the system will operate from standby batteries only for a specified time.

Rate-of-Rise heat detectors may be subject to reduced sensitivity over time. For this reason, the rate-of-rise feature of each detector should be tested at least once per year by a qualified fire protection specialist.

Equipment used in the system may not be technically compatible with the control. It is essential to use only equipment listed for service with your control panel.

Telephone lines needed to transmit alarm signals from a premise to a central monitoring station may be out of service or temporarily disabled.

The most common cause of fire alarm malfunctions, however, is inadequate maintenance. All devices and system wiring should be tested and maintained by professional fire alarm installers following written procedures supplied with each device. System inspection and testing should be scheduled monthly or as required by National and/or local fire codes. Adequate written records of all inspections should be kept.

FCC Warning

WARNING: This equipment generates, uses, and can radiate radio frequency energy and if not installed and used in accordance with the instruction manual, may cause interference to radio communications. It has been tested and found to comply with the limits for class A computing device pursuant to Subpart B of Part 15 of FCC Rules, which is designed to provide reasonable protection against such interference when operated in a commercial environment. Operation of this equipment in a residential area is likely to cause interference, in which case the user will be required to correct the interference at his own expense.

Canadian Requirements

This digital apparatus does not exceed the Class A limits for radiation noise emissions from digital apparatus set out in the Radio Interference Regulations of the Canadian Department of Communications.

Le présent appareil numérique n'émet pas de bruits radioélectriques dépassant les limites applicables aux appareils numériques de la classe A prescrites dans le Règlement sur le brouillage radioélectrique édicté par le ministère des Communications du Canada.

Table of Contents

	NFPA Standards, UL Documents	5
1.0	Product Description	7
	Figure 1-1: Optional DP-5024UD	7
	Figure 1-2: SA500C Panel	8
1.2	Controls and Indicators	9
	Figure 1-3: Controls and Indicators	9
1.3	Circuits	9
1.4	Digital Communicator	10
1.5	Components	10
	Figure 1-4: XRM-24 Transformer	10
1.6	Optional Devices	11
1.7	Specifications	12
1.8	Telephone Requirements and Warnings	13
2.0	Installation	15
2.1	General	15
2.2	Backbox Mounting	15
	Figure 2-1: Cabinet Dimensions & Knockouts	16
	Figure 2-2: Backbox and Battery Box	17
2.3	Operating Power	18
	Figure 2-3: Operating Power Connections	18
	Figure 2-4: Auxiliary Power Connections	19
2.4	Input Circuits	19
2.5	Output Circuits	20
	Figure 2-5: Typical Initiating Device Circuit Connect	20
	Figure 2-6: Notification Appliance Circuit Connections	21
	Figure 2-7: Aux Relay and Relay Driver Terminals	22
2.6	UL Power-limited Wiring Requirements	23
	Figure 2-8: Typical Wiring for UL Power-limiting	23
2.7	Digital Communicator	24
	Figure 2-9: Wiring Phone Jack	24
2.8	Optional Boards	25
	Figure 2-10: ADM-24	25
	Figure 2-11: RZA-5F	25
	Figure 2-12: Wiring the RZA-5F/ADM-24	26
	Figure 2-13: Installing the Annunciator	26
	Figure 2-14: Remote Printer Connections	27
	Figure 2-15: RM-5F	28
	Figure 2-16: CAC-5F Style D Converter	29
3.0	Programming Instructions	30
3.1	Entering Program Mode	30
3.2	Switch Functions	31
	Figure 3-1: Control Panel Keypad	31
3.3	Programming Options	31
	Table 3-1: Event Codes, Primary C. S. Number	34
	Table 3-2: Event Codes, Primary C. S. Number	34
	Table 3-3: Event Codes, Secondary C. S. Number	36
	Table 3-4: Event Codes, Secondary C. S. Number	37
	Figure 3-2: Verification Timing Diagram	38
3.2	Default Programming	43

Table of Contents

4.0	Operating Instructions	44
4.1	Switches	44
4.2	Displays	45
	Figure 4-1: Phone Connectors & LEDs	46
4.3	Operation	47
4.4	Central Station Communications	50
	Table 4-1: Format Selection Addresses (16+42)	51
	Table 4-2: Format Selection Address Explanation	52
	Table 4-3: Compatible UL Listed Receivers	54
5.0	Servicing	55
5.1	Walk Test Mode	55
5.2	History Mode	56
5.3	Troubleshoot Mode	58
5.4	Lamp Test	59
	Figure 5-1: Handset/Speaker Connection	59
5.5	Print Mode	60
6.0	Slave Communicator Configuration	61
	Figure 6-1: Slave Communicator Connections	62
7.0	Remote Site Upload/Download	63
7.1	Downloading Program: General	63
	7.1.1 Security Features	64
7.2	Downloading Initiated at Control Panel	65
7.3	Downloading Initiated at Service Terminal	65
7.4	Uploading Initiated at Service Terminal	66
	Appendix A: Battery Calculations	67
	Appendix B: Programming Reference Sheets	70
	Appendix C: Operation and Function Modes	76

This control panel has been designed to comply with standards set forth by the following regulatory agencies:

- Underwriters Laboratories Standard UL 864
- NFPA 72-1993 National Fire Alarm Code for Local, Remote Station and Central Station Fire Alarm System
- CAN/ULC - S527-M87 Standard for Control Units for Fire Alarm Systems

Before proceeding, the installer should be familiar with the following documents.



NFPA Standards:

NFPA 72-1993 National Fire Alarm Code
Central Station Fire Alarm Systems (Automatic, Manual, and Waterflow) Protected Premises Unit
Local Protective Fire Alarm Systems (Automatic, Manual, Waterflow and Sprinkler Supervisory)
Auxiliary Protective Fire Alarm Systems (Automatic, Manual and Waterflow)
Remote Station Protective Fire Alarm Systems (Automatic, Manual and Waterflow)
Proprietary Protective Fire Alarm Systems (Automatic, Manual and Waterflow)



Underwriters Laboratories Documents:

UL 38 Manually Actuated Signaling Boxes
UL 217 Smoke Detectors, Single and Multiple Station
UL 228 Door Closers—Holders for Fire Protective Signaling Systems
UL 268 Smoke Detectors for Fire Protective Signaling Systems
UL 268A Smoke Detectors for Duct Applications
UL 346 Waterflow Indicators for Fire Protective Signaling Systems
UL 464 Audible Signaling Appliances
UL 521 Heat Detectors for Fire Protective Signaling Systems
UL 864 Standard for Control Units for Fire Protective Signaling Systems
UL 1481 Power Supplies for Fire Protective Signaling Systems
UL 1638 Visual Signaling Appliances
CAN/ULC - S524-M91 Standard for Installation of Fire Alarm Systems

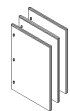

Other:

NEC Article 300 Wiring Methods
NEC Article 760 Fire Protective Signaling Systems
Applicable Local and State Building Codes
Requirements of the Local Authority Having Jurisdiction

Documents:

Device Compatibility Document Document #50577

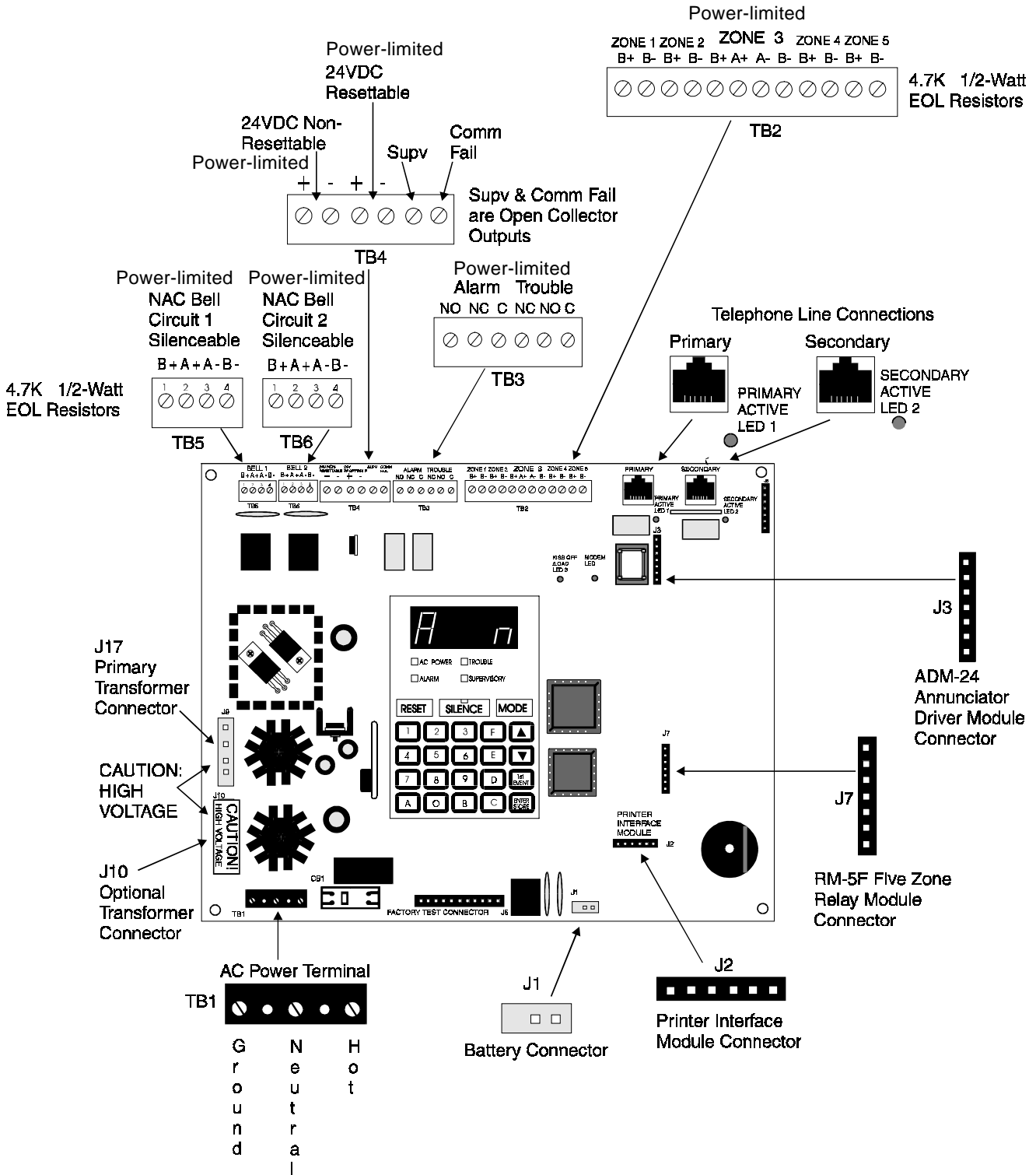

1.0 Product Description

The SA500C is a combination control panel and digital communicator all on one circuit board. It is a five-zone panel which uses conventional input devices. The panel accepts waterflow devices, two-wire smoke detectors, four-wire smoke detectors, pull stations and other normally open contact devices. Outputs include two Notification Appliance Circuits, alarm and trouble relays, supervisory and communicator failure relay drivers.

The integral communicator transmits system status (alarms, troubles, AC loss, etc.) to UL-listed Central Stations via the public switched telephone network. The control panel has a built in programmer and may also serve as a slave communicator to a host panel. It also supervises all wiring, AC voltage, telephone line input voltage and battery level.

The control panel may be programmed or interrogated off site via the public switched telephone network. Any IBM compatible personal computer with DOS™ 4.01 or greater plus Windows™ 3.1 or greater, with a 1200 Baud Hayes™ compatible modem and Upload/Download software P/N PK-5024UD, may serve as a Service Terminal. This allows download of the entire program or upload of the entire program, history file, walktest data, current status and system voltages.

1.1 Product Features

- Selectable as Fire Panel, Fire Panel/Communicator, or Slave Communicator
- Programmable Zone ID: 2 Wire Smoke; Pull Station; Normally Open Contact; Supervisory; Supervisory-Auto Silence; Waterflow-Silenceable; Waterflow-Non-Silenceable
- One Style D (Class A) Zone
- Four Style B (Class B) Zones
- 3.6 amps Usable Power Expandable to 5.6 amps
- 5 Zone Relay Option Module (RM-5F)
- CAC-5F Style D Class A Zone Converter Module
- Two NFPA Style Y or Z (Class B or A) Notification Appliance (bell) Circuits
- Built-in Programmer
- Built-in Voltmeter
- Telephone Line Active LED Indicators
- Communication Confirmation (Kissoff) LED
- Disable report by event
- Programmable Event Codes
- 24 Volt Operation
- Real Time Clock and Calendar
- Trouble Reminder
- Alarm Verification
- RZA-5F Remote Annunciator (requires ADM-24 Annunciator Driver Module)
- Small Size 15" x 14.5" x 2.75"
- History File with 32 Event Storage
- Silence Inhibit per Notification Appliance Circuit
- Auto-Silence per Notification Appliance Circuit
- Touchtone/Rotary Dialing
- Programmable Make/Break Ratio
- Fuseless
- Printer Interface Module (PRT-24)

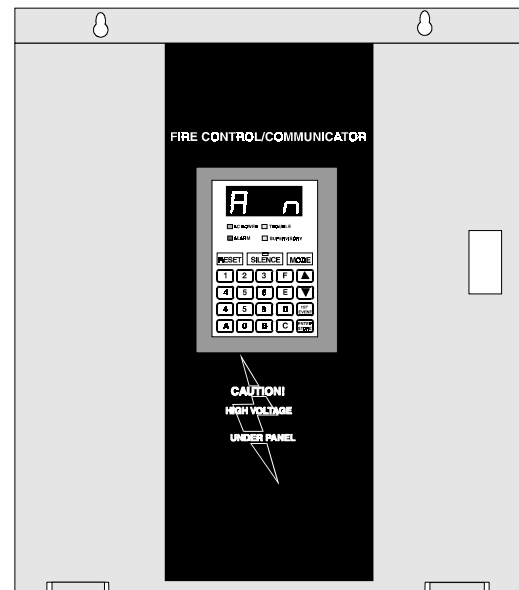
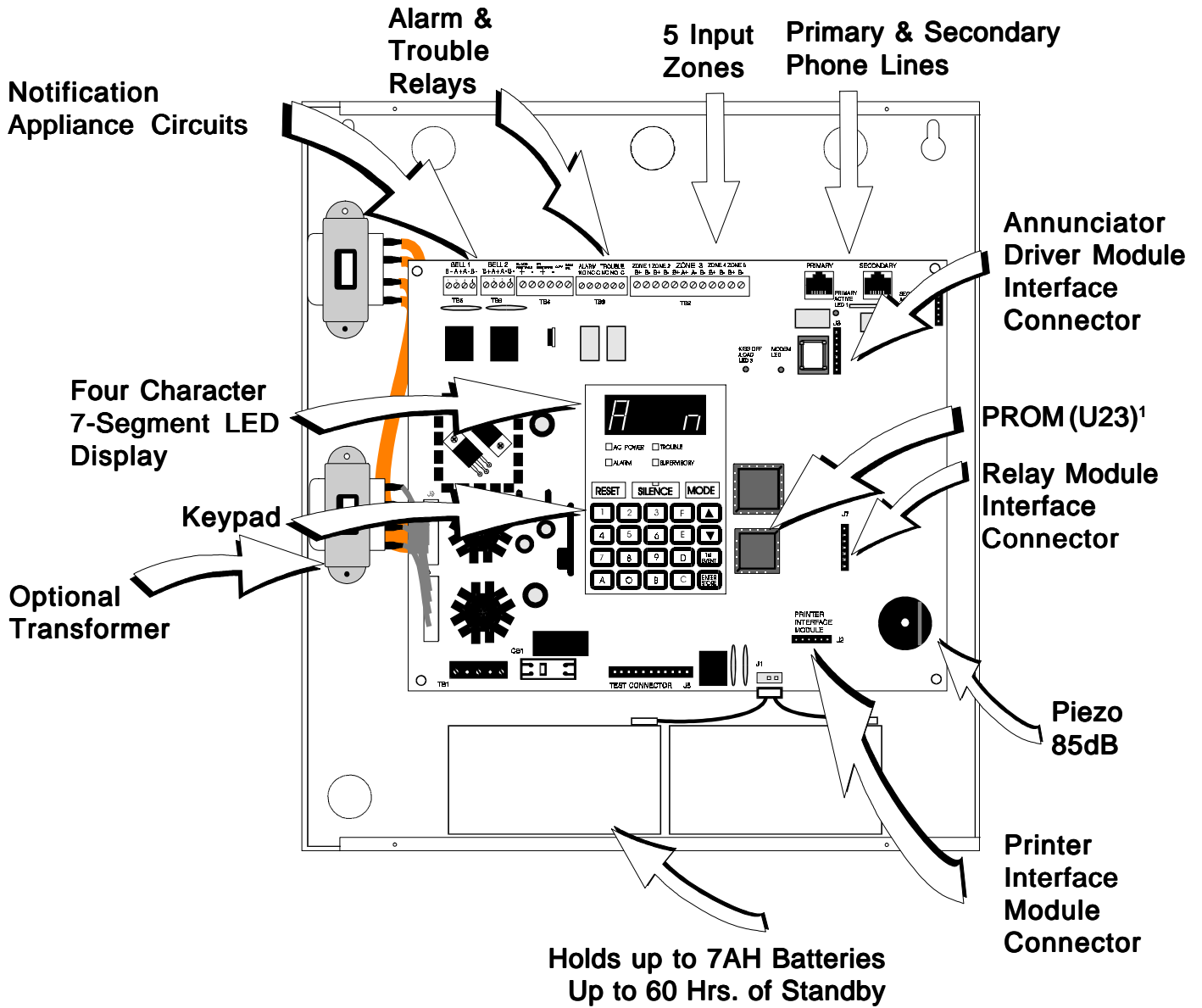

Figure 1-1: Optional DP-5024UD

- Print Real-time System Status
- Print History & Walk Test Files, Program Contents, & Troubleshoot mode voltages
- PK-5024UD Upload/Download Software Kit.
- Number of dial attempts (5 min, 10 max)
- Programmable Channel ID (slave)
- Programmable Zone Delay (waterflow only)
- Form-C Alarm and Trouble Relays
- Supervisory, Communication Fail Relay Drivers
- Low AC Voltage Sense
- One Man Walk Test
- Optional Dead Front cover (DP-5024UD)



Note:

¹Software for the Fire Control Communicator is located in a PROM inserted in the IC socket labeled U23.

Figure 1-2: SA500C Panel

1.2 Controls and Indicators

Front Panel Switches

RESET	Digits 0-9
SILENCE	A
MODE	B
Up Arrow	C
Down Arrow	D
1st EVENT	E
ENTER/STORE	F

Displays

- Alarm - red LED
- Trouble - yellow LED
- Supervisory - yellow LED
- AC Power - green LED
- Four, Seven Segment Displays - red
- Primary Phone Line Active - red LED
- Secondary Phone Line Active - red LED
- 'Kissoff' Signal from Central Station - green LED
- Silence - yellow LED
- Modem - green LED

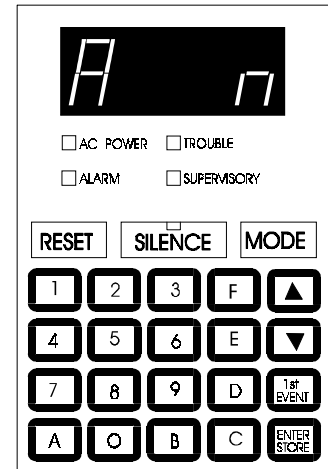

Figure 1-3: Controls and Indicators

Local Sounder - A piezo sounder provides separate and distinct sounds for alarm, trouble and supervisory conditions.

1.3 Circuits

Input Circuits

Five input circuits provide Style B configuration with one circuit also configurable for Style D. Input circuits may be used as standard fire control panel zones or slave communicator input channels.

Initiating Device Circuit 1 (Style B) accepts Normally Open contact devices and 2-wire smoke detectors.

Initiating Device Circuit 2 (Style B) accepts Normally Open contact devices and 2-wire smoke detectors.

Initiating Device Circuit 3 (Style B/D) accepts Normally Open contact devices, 2-wire smoke detectors and waterflow devices.

Initiating Device Circuit 4 (Style B) accepts Normally Open contact devices and 2-wire smoke detectors.

Initiating Device Circuit 5 (Style B) accepts Normally Open contact devices and 2-wire smoke detectors.

Output Circuits

- 24 Volt Resettable Power Output
- 24 Volt Non-Resettable Power Output
- Primary Telephone Line
- Secondary Telephone Line
- 24 Volt Battery Charger
- Printer Port

Notification Appliance Circuits - Two Notification Appliance Circuits configurable for Style Y (Class B) or Style Z (Class A) with various programmable features.

Relays - Two dry Form-C relay contacts for System Alarm and System Trouble are provided. Contacts are rated 2 amps at 30 VDC and 0.5 amps at 30 VAC resistive.

Relay Drivers - Two relay drive outputs for supervisory and communication failure are available.

1.4 Digital Communicator

Two modular phone jacks allow easy connection to telephone lines. Modular jacks are labeled PH1 and PH2 for the Primary and Secondary phone lines. Telephone line active red LEDs are provided as well as a green 'Kissoff' LED. The integral digital communicator provides the following functions:

- Line Seizure - takes control of the phone lines disconnecting any premises phones.
 - Off/On Hook - perform on and off-hook status to the phone lines.
 - Listen for dial tone - 440 hertz tone typical in most networks.
 - Dialing the Central Station(s) number - default is Touch-Tone®, programmable to rotary.
 - For tone burst or touchtone type formats: Discern proper 'Ack' and 'Kissoff' tone(s) - The frequency and time duration of the tone(s) varies with the transmission format. The control panel will adjust accordingly.
 - Communicate in the following formats:
 - ✓ 12 Tone Burst Types: 20 pps
(3+1, 4+1, 4+2, 3+1 Exp., 4+1 Exp., 4+2 Exp.)
 - ✓ 2 Touchtone Types:
 - 4 + 1 Ademco Express
 - 4 + 2 Ademco Express
- See Table 4-3 for list of compatible receivers.*

1.5 Components

Main Circuit Board

The main circuit board contains the system's CPU, power supply, other primary components and wiring interface connectors. Optional modules plug in and are mounted to the main circuit board. The main circuit board is delivered pre-mounted in the cabinet.

Cabinet

The cabinet is red with an attractive navy blue front overlay. The backbox measures 15" x 14.5" x 2.75" and provides space for two batteries (up to 7 Amp Hours). Also available is an optional dress panel, DP-5024UD, which mounts inside the cabinet.

Transformer Assembly

One 100VA transformer is provided standard with the panel (3.6 amps max.). An optional 100VA transformer, XRM-24, is available to provide maximum accessory power (6.6 amps max.).

Batteries

The cabinet provides space for 7 Amp Hour batteries (for 12 Amp Hour to 17 Amp Hour batteries use the listed BB-17F battery box). Batteries must be ordered separately.

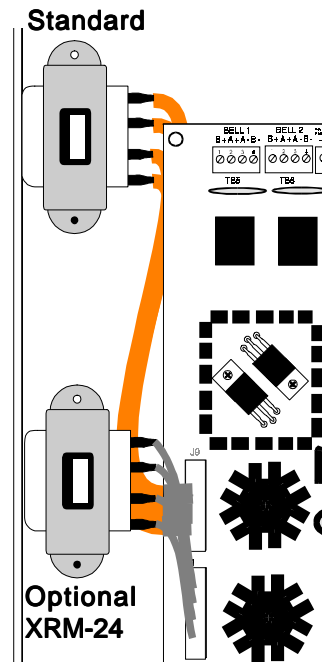

Figure 1-4: XRM-24 Transformer

1.6 Optional Devices

RM-5F Five-Zone Relay Module

The RM-5F option module provides 5 Form-C relays which track zones 1 through 5. The module mounts to connector J7 on the lower right side of the main board. See Figures 1-2 and 2-13.

CAC-5F

The CAC-5F Class A Converter module converts the Style B (Class B) Initiating Circuits to Style D (Class A). The CAC-5F mounts to terminal block TB2 located in the upper center of the main circuit board. The removable terminal block on the CAC-5F module provides for ease of wiring (refer to Figure 2-16).

ADM-24

The ADM-24 Annunciator Driver Module supports the RZA-5F Remote Annunciator module. Annunciator wiring is supervised for open circuits by this module. The Annunciator Driver Module mounts to connector J3 in the upper right corner of the main board. See Figure 1-2 and 2-8.

Remote Annunciator

The RZA-5F Remote Annunciator mounts on a standard single-gang box, and provides LED indication of the following:

- Alarm Zone 1 (red)
- Alarm Zone 2 (red)
- Alarm Zone 3 (red)
- Alarm Zone 4 (red)
- Alarm Zone 5 (red)
- System Trouble (yellow)

A Local Trouble Sounder and Tone Silence Switch are also provided. All LEDs and their wiring are supervised for open conditions. Any open condition will cause the System Trouble LED to illuminate. Slide in paper labels permit an easy change of zone information. See Figure 2-10. **Note:** *The Remote Annunciator requires the use of the ADM-24 Annunciator Driver Module.*

Printer Interface Module-PRT-24

The Printer Interface Module may be used to connect a printer to the control panel for the purpose of printing a history report, Walk Test file, troubleshoot report, program entries or current system status. Printers require separate external primary power. Connect the PRT-24 module (with cable) to the serial EIA-232 port on the printer. The module mounts to the J2 connector on the main circuit board. **Note:** *An EDP listed printer must be used if printer will be permanently attached.* See Figure 2-13.

Dress Panel

A red dead-front dress panel (DP-5024UD) is available as an option (required for Canadian installations). The dress panel restricts access to the system wiring while allowing access to the membrane switch panel. See Figure 1-1.

Battery Box

The BB-17F battery box may be used to house two 12 Amp Hour or 17 Amp Hour batteries. The battery box mounts directly below the main circuit board in the cabinet (refer to Figure 2-2). The BB-17F is red and is provided with knockouts.

Program Kit - PK-5024UD

This kit includes two diskettes, one 5 1/4" P/N 75327, one 3 1/2" P/N 75328 plus Instruction Manual P/N 50041. When the software is loaded into an IBM compatible computer, it creates an off-line Service Terminal that allows any SA500C panel to be uploaded or downloaded over standard telephone lines.

1.7 Specifications

AC Power - TB1

SA500C: 120 VAC, 60 Hz, 2.3 amps

Wire size: minimum #14 AWG with 600V insulation

Battery (lead acid only) - J1

Maximum Charging Circuit: Normal Flat Charge—27.6V @ .8 amp

Maximum Charger Capacity: 17 Amp Hour battery. (SA500C cabinet holds max. 7 Amp Hour battery. Larger batteries require BB-17F or other UL listed battery cabinet).

Initiating Device Circuits TB2

Detector Zones 1, 2, 3, 4, 5 Power-Limited Circuitry

Operation: All zones (NFPA Style B), Zone 3 (NFPA Style B or D). Use CAC-5F module for Style D operations

Normal Operating Voltage: 24 VDC (ripple = 100 mV max)

Alarm Current: 26 mA Short Circuit Current: 42 mA max.

Maximum Loop Resistance: 100 ohms

End-of-Line Resistor: 4.7K, 1/2-Watt (part # 27072 UL listed)

Detector Loop Current is sufficient to ensure operation of one alarmed detector per zone.

Standby Current: 7.26 mA (includes ELR and 2 mA maximum detector current)

Smoke Detector Identifier A

Refer to Device Compatibility Document for listed compatible devices.

Notification Appliance Circuits - TB5 & TB6

Non-regulated special purpose power, Styles Y and Z supported

Power-limited circuitry

Operating Voltage Nominal 24 volts

Current for all external devices: 3.0 amps expandable to 5.6 amps

Current Limit: PTC

Max. signaling current/circuit: 2.5 amps

End-of-line resistor: 4.7K, 1/2-Watt (part # 71252 UL listed) for NACs.

Refer to Device Compatibility Document for listed compatible devices.

Alarm and Trouble Relays - TB3

Contact rating: 2.0 amps @ 30 VDC (resistive), 0.5 amps @ 30 VAC (resistive) Alarm and Trouble: Form-C Power-limited Circuitry (see Figure 2-7 note for power-limited wiring application).

Auxiliary Outputs TB4, Terminals 5 - 6

TB4-5 Supervisory Relay Driver. Normally high, active low. Sinks up to 40 mA.

TB4-6 Communication Failure. Normally high, active low. Sinks up to 40 mA.

Power-limited Circuitry.

Four-wire Smoke Detector Power - TB-4 Terminals 3 (+) & 4 (-)

Max. ripple voltage: 10 mV_{RMS} Operating Voltage nominal 24 volts

Up to 300 mA is available for powering 4-wire smoke detectors.

Power Limited Circuitry. Recommended maximum Standby current is 50 mA (see Battery Calculations in Appendix A).

Refer to Device Compatibility Document for compatible listed devices.

Nonresettable Regulated 24V Power - TB-4 Terminals 1 (+) & 2 (-)

Max. ripple voltage: $10 \text{ mV}_{\text{RMS}}$ Operating Voltage nominal 24 volts

Total DC current available from this output is up to 300 mA.

Power Limited Circuitry. Recommended maximum Standby current is 150 mA (see Battery Calculations in Appendix A).

Refer to Spectronics Compatibility Chart for compatible listed devices.

Notes:

- 1) For power supply calculations, refer to Appendix A.
- 2) Total current for non-resettable power, four-wire smoke power, and two Notification Appliance Circuits *must not exceed 5.6 amps*. Total external system current in excess of 3.6 amps requires the XRM-24 Transformer and 12 Amp Hour or 17 Amp Hour batteries.

1.8 Telephone Requirements and Warnings

1.8.1 Telephone Circuitry:

Ringer Equivalence Number (REN) = 1.3B

AC Impedance 10.0 Mega Ohm

Complies with FCC Part 68

Mates with RJ31X Male Connector

Supervision Threshold: less than 4.0 volts for 2 minutes

The REN is used to determine the quantity of devices which may be connected to the telephone line. Excessive REN's on the telephone line may result in the devices not ringing in response to an incoming call. In most, but not all areas, the sum of the REN's should not exceed five (5.0). To be certain of the number of devices that may be connected to the line, as determined by the total REN's, contact the telephone company to determine the maximum REN for the calling area.

1.8.2 Digital Communicator:

Before connecting the control panel to the public switched telephone network, the installation of two RJ31X jacks is necessary. The following information is provided if required by the local telephone company :

Manufacturer : Fire-Lite Alarms, Inc.
One Fire-Lite Place
Northford, CT 06472

Product Model Number: SA500C
FCC Registration Number: 1W6USA-20004-AL-E
Ringer Equivalence 1.3B

1.8.3 Telephone Company Rights and Warnings:

The telephone company under certain circumstances may temporarily discontinue services and/or make changes in its facilities, services, equipment or procedures which may affect the operation of this control panel. However, the telephone company is required to give advance notice of such changes or interruptions.

If the control panel causes harm to the telephone network, the telephone company reserves the right to temporarily discontinue service. Advance notification will be provided except in cases when advance notice is not practical. In such cases, notification will be provided as soon as possible. The opportunity will be given to correct any problems and to file a complaint.

DO NOT CONNECT THIS PRODUCT TO COIN TELEPHONE, GROUND START, OR PARTYLINE SERVICES.

When the control panel activates, premise phones will be disconnected.

Two separate phone lines are required. Do not connect both telephone interfaces to the same telephone line.

The control panel must be connected to the public switched telephone network upstream of any private telephone system at the protected premises.

An FCC compliant telephone cord must be used with this equipment. This equipment is designed to be connected to the telephone network or premises wiring using a compatible RJ31X male modular plug which is Part 68 compliant.

2.0 Installation

2.1 General Mounting Options

The cabinet may be either semi-flush or surface mounted. The door is removable during the installation period by opening and lifting off the hinges.

The cabinet mounts using two key slots and two additional 0.250" diameter holes located in the backbox. The key slots are located at the top of the backbox and the two securing holes at the bottom.

Carefully unpack the system and check for shipping damage. Mount the cabinet in a clean, dry, vibration-free area where extreme temperatures are not encountered. The area should be readily accessible with sufficient room to easily install and maintain the panel. Locate the top of the cabinet approximately five feet above the floor with the hinge mounting on the left. Determine the number of conductors required for the devices to be installed. Sufficient knockouts are provided for wiring convenience. Select the appropriate knockout(s) and pull the required conductors into the box. Note that there are no knockouts on the left (hinged) side of the cabinet. All wiring should be in accordance with the National and/or Local codes for fire alarm systems.

2.2 Backbox Mounting

- Open the door and lift the door off the pin hinges.
- Remove the main PC board assembly by unscrewing the four screws in the corners of the board. Two standoffs support the board in the center. Set the board aside in a safe, clean place. Avoid static discharge which may damage the board.
- Mark and predrill holes for the top two keyhole mounting bolts using the dimensions shown.
- Install two upper fasteners in the wall with the screw heads protruding.
- Using the upper 'keyholes', mount the backbox over the two screws.
- Mark and drill the lower two holes.
- Mount backbox, install remaining fasteners and tighten.
- When the location is dry and free of construction dust, reinstall the main PC board.

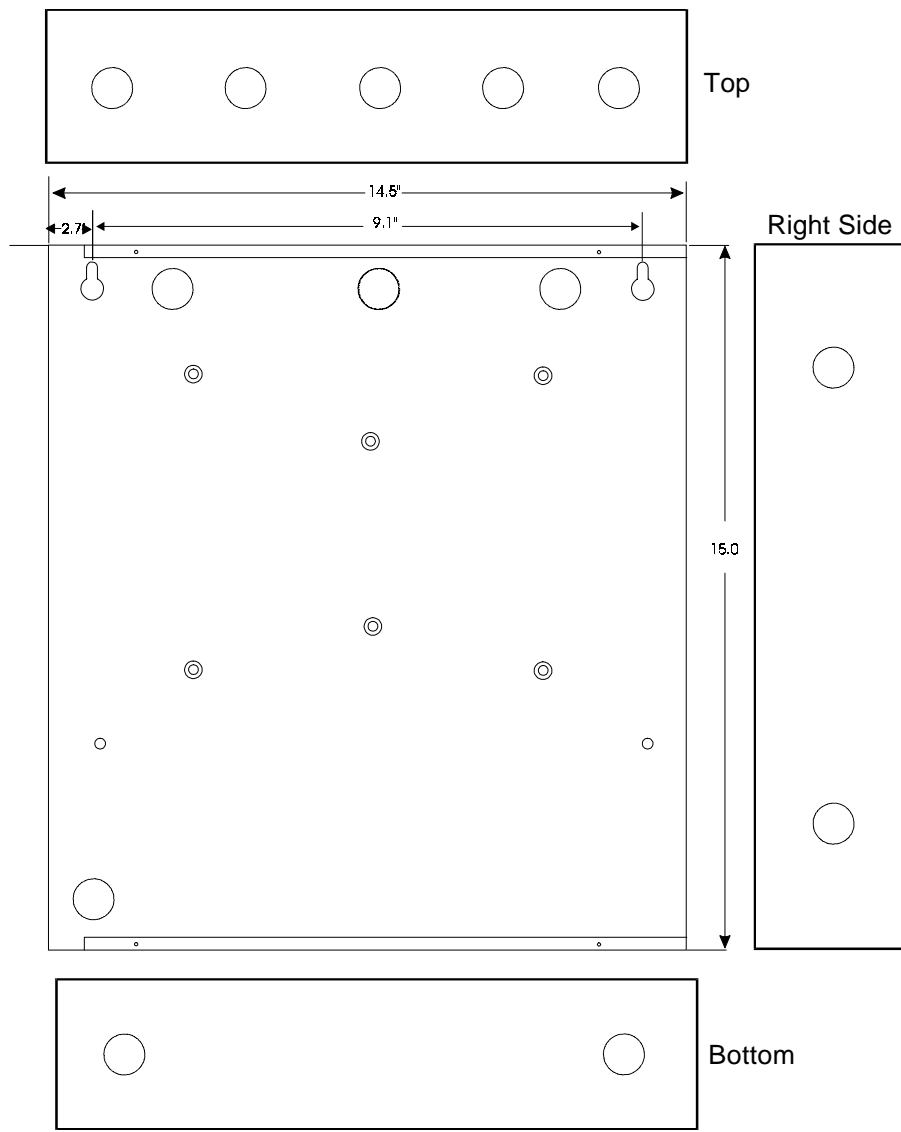

TR-1-R Trim Ring

Draw wires through the respective knockout locations.

Figure 2-1: Cabinet Dimensions & Knockout Locations

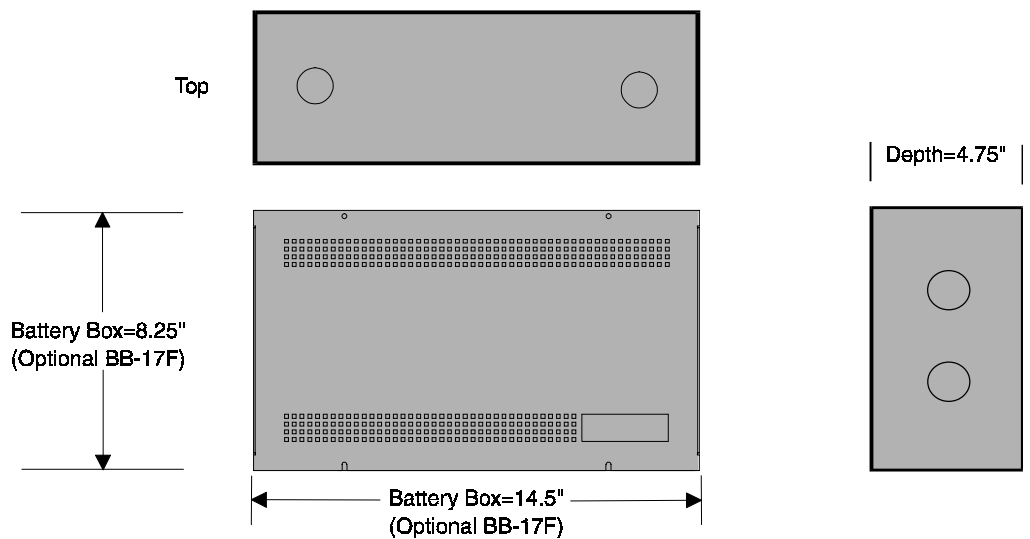
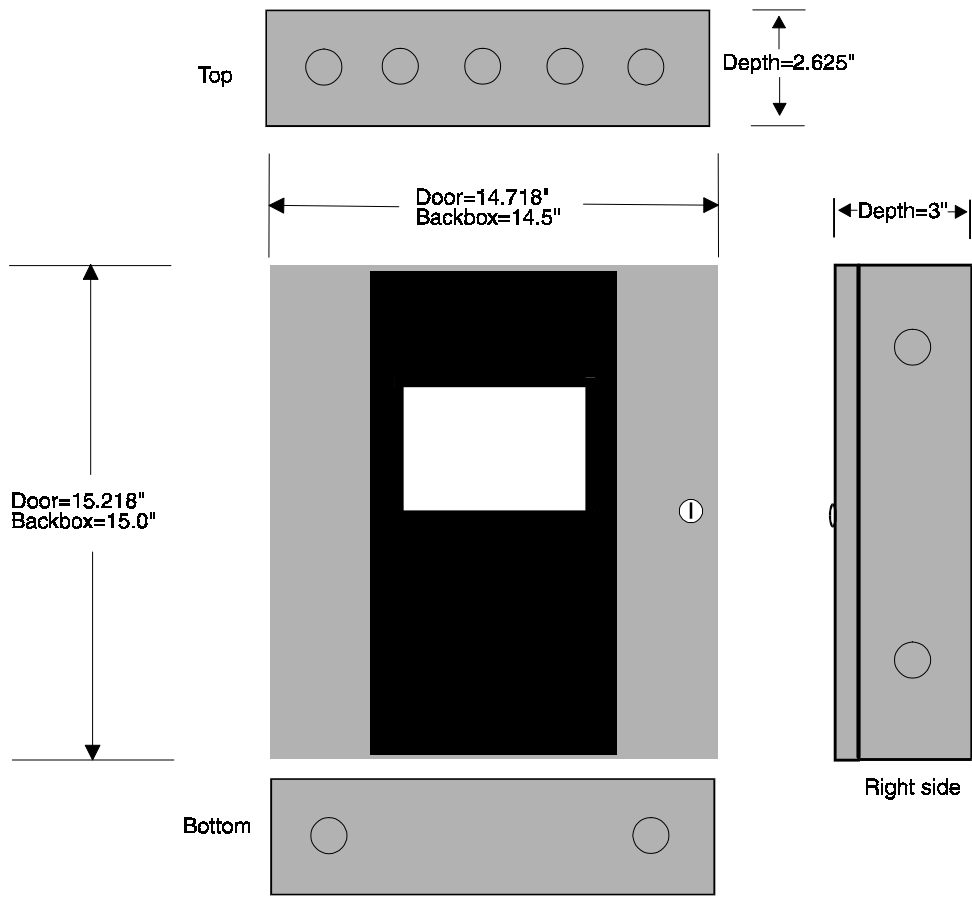

Notes:

- 1) Mount the Fire Control Communicator cabinet to the wall.
- 2) Remove knockouts on bottom of FACP cabinet and top of BB-17F.
- 3) Using conduit, hang BB-17F from the Fire Control Communicator cabinet making sure there is at least 1/2" of clearance between the two cabinets.
- 4) Anchor BB17-F to wall.

Figure 2-2: Backbox and Battery Box

2.3

Operating Power

CAUTION: Several different sources of power can be connected to this panel. Disconnect all sources of power before servicing. The panel and associated equipment may be damaged by removing and/or inserting cards, modules, or interconnecting cables while this unit is energized.

Primary Power Source (AC) and Earth Ground Connections

AC power connections are made inside the control panel cabinet. The primary power source for the SA500C is 120 VAC, 60 HZ, 2.3 amps. Run a pair of wires (with ground conductor) from the protected premises main breaker box to TB1 of the main circuit board. As per the National Electric Code, use 14 AWG (1.6 mm O.D.) or heavier gauge wire with 600V insulation. No other equipment may be connected to this circuit. In addition, this circuit must be provided with overcurrent protection and may not contain any power disconnect devices. A separate Earth Ground connection must be made to ensure proper panel operation and lightning and transient protection. Connect the Earth Ground wire (minimum 14 AWG) to one of the transformer mounting studs. Note: Do not use conduit for the Earth Ground connection since this does not provide reliable protection.

Secondary Power Source (Batteries)

Observe polarity when connecting the battery. Connect the battery cable to J1 on the main circuit board using the plug-in connector provided. The battery charger is current limited and capable of recharging sealed lead acid type batteries. The charger shuts off when the system is in alarm. See Appendix A for calculation of the correct battery rating. **CAUTION:** Battery contains sulfuric acid which can cause severe burns to the skin and eyes, and can destroy fabrics. If contact is made with sulfuric acid, immediately flush the skin or eyes with water for 15 minutes and seek immediate medical attention.

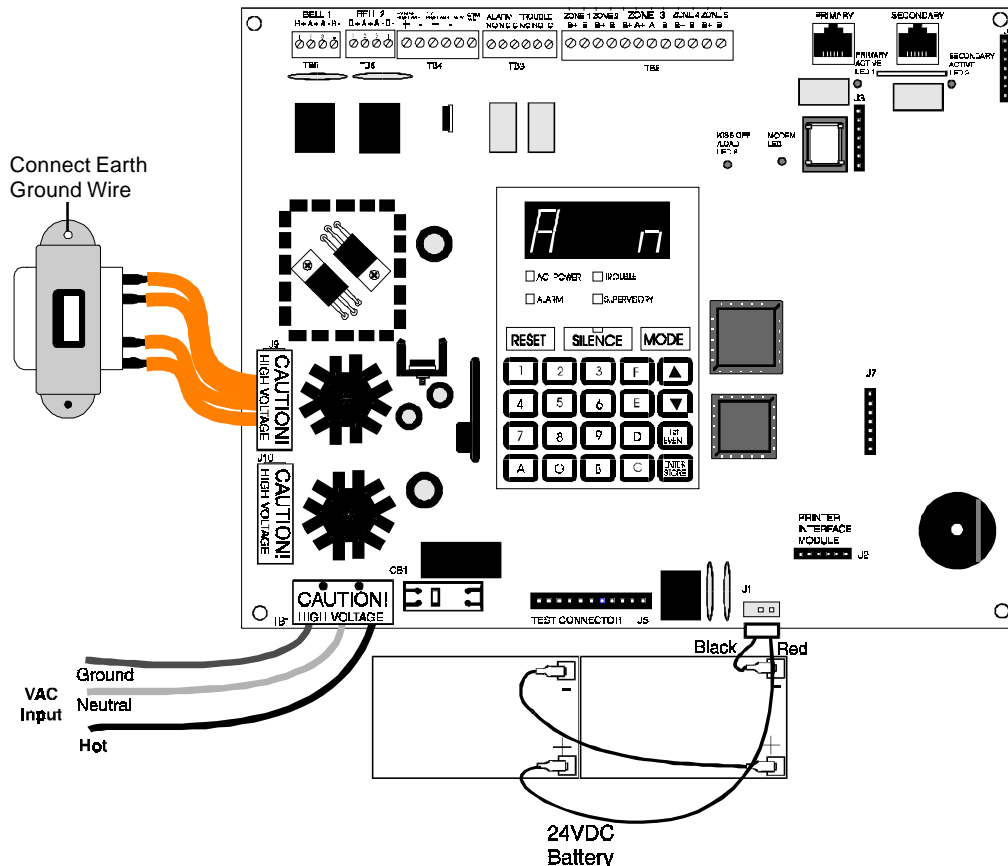

Figure 2-3: Operating Power Connections

DC Power Output Connections

All DC power outputs are power-limited

Nonresettable Power (300 mA)
24 VDC filtered, regulated, non-resettable power can be obtained from TB4 Terminals 1 (+) and 2 (-).

4-Wire Smoke Detector Power (300 mA)
24 VDC filtered, regulated, resettable power for 4-wire smoke detectors can be obtained from TB4 Terminals 3 (+) and 4 (-).

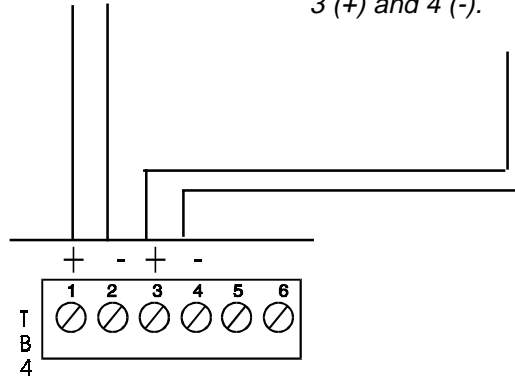

Figure 2-4: Auxiliary Power Connections

2.4 Input Circuits

The control panel has five zone input circuits. The maximum loop resistance limit for each is 100 ohms. All field wiring of each zone is supervised for opens and ground faults. Both conditions are visually and audibly annunciated as well as communicated to a Central Station.

Each zone is a Style B Initiating Device Circuit (IDC) designed to accept any Normally Open contact device and conventional 2-wire, 24 volt smoke detectors. Each zone is power limited to 7.26 mA in standby and 42 mA in alarm. Zone 3 may also be configured as a Style D Initiating Device Circuit.

Note: All five initiating zones may be converted to Style D (Class A) by using a CAC-5F Class A Converter module (refer to Figure 2-16).

Zones 1-5 may be programmed as shown below. The factory default is 2-wire smoke detector for all zones.

- 2-wire Smoke Detector (factory default)
- Pull Station
- Normally Open Contact Device(s)
- Supervisory
- Supervisory, Auto-Resettable

Zone 3 may also be programmed as:

- Waterflow Silenceable
- Waterflow, Non-Silenceable

Note: A maximum of five waterflow devices may be used on zone 3 per NFPA 72.

Four-wire smoke detectors may be connected to any zone. Resettable power is provided via terminals TB4, 3 and 4.

It is allowable to mix an assortment of device types (ie, smoke detectors, heat detectors, pull stations) on any zone. However, this is not recommended since specific and detailed reports will not be possible. For example, the report of general fire alarm versus pull station fire alarm or smoke detector fire alarm.

Refer to the Device Compatibility Document #50577 for a list of compatible smoke detectors.

Style B Initiating Device Circuit
(Supervised and power-limited).
 4.7KΩ, 1/2-Watt Part# 71252 UL listed.

Style D Initiating Device Circuit
(Supervised and power-limited)..

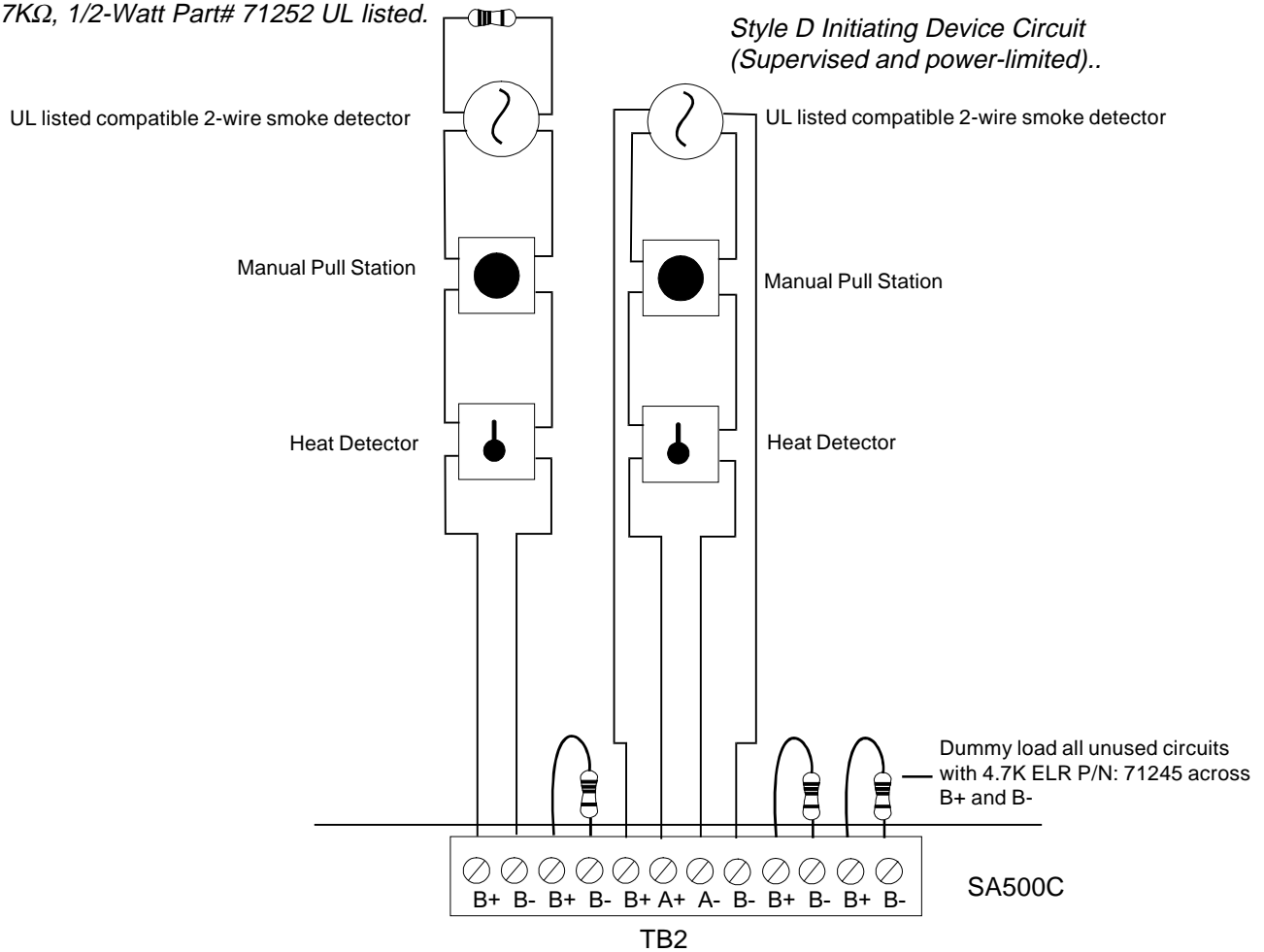

Figure 2-5: Typical Initiating Device Circuit Connections

2.5 Output Circuits

Telephone Circuits

Provision to connect to two independent telephone lines is available via two telephone jacks labeled PH1 (Primary) and PH2 (Secondary). Telephone line control/command is possible via double line seizure as well as usage of an RJ31X style interconnection. See Figure 2-9.

Notification Appliance Circuits

The SA500C provides two Notification Appliance Circuits (Style Y or Z). Each circuit is capable of 2.5 amps of current. Total current drawn from these as well as other DC power outputs cannot exceed 3.6 amps with the standard transformer, 5.6 amps if an optional XRM-24 transformer is installed. Circuits are supervised and power-limited. Refer to the Spectronics Device Compatibility Document for a listing of compatible Notification Appliances.

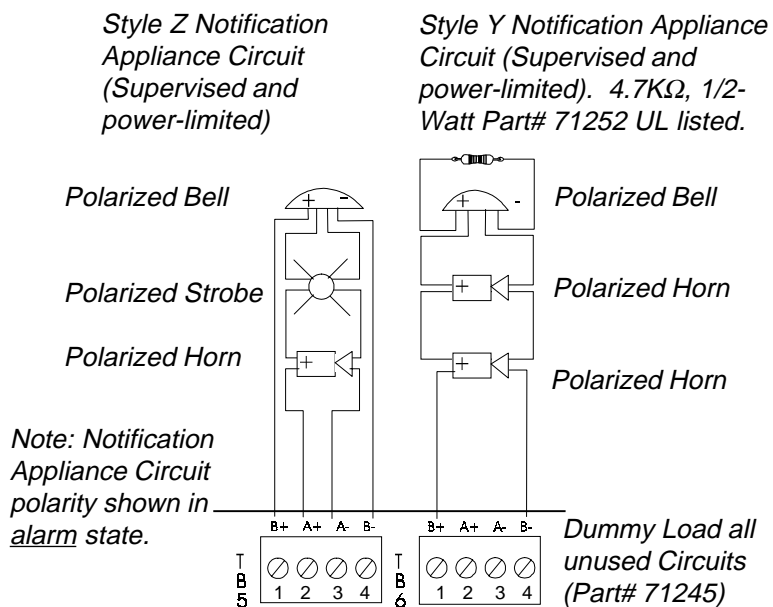

Figure 2-6: Notification Appliance Circuit Connections

Both Notification Appliance Circuits may be programmed as follows:

- Silenceable
- Non Silenceable
- Enabled/Disabled
- Silence Inhibited
- Auto Silence, 5 to 30 minutes
- Coded (March Time, Temporal, California)

Standard Relays

The control panel provides a set of Form-C alarm and a set of Form-C trouble contacts rated for 2.0 amps @ 30VDC (resistive).

Relay Drivers

Relay driver outputs are provided for Supervisory and Communicator Failure. These outputs can be used to drive UL-864 listed remote relays such as the MR-101C and MR-201C.

The control panel's open collector outputs on TB4, terminals 5 and 6 can be used to activate UL-864 listed relays. Outputs are rated for 40 mA. The normal condition for each output is as shown below:

TB4-5 Supervisory	Off (de-energized)
TB4-6 Communications Failure	Off (de-energized)

Relays must be placed inside the cabinet or in a UL-864 recognized enclosure. Wiring from the control panel's terminals on TB4 to the relays must be less than 3 feet in length and enclosed in conduit. Wiring from the relay outputs must remain in the same room as the location of the enclosure and be enclosed in conduit.

Relay Connections

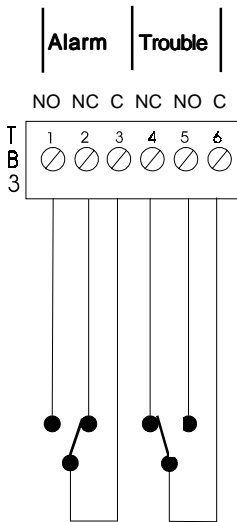

Note: The alarm and trouble Form-C dry contact relays must be power-limited circuits. Any Form-C dry contact relay that may be used must be wired from TB4 or a UL listed power-limited power supply.

Relay Driver Connections

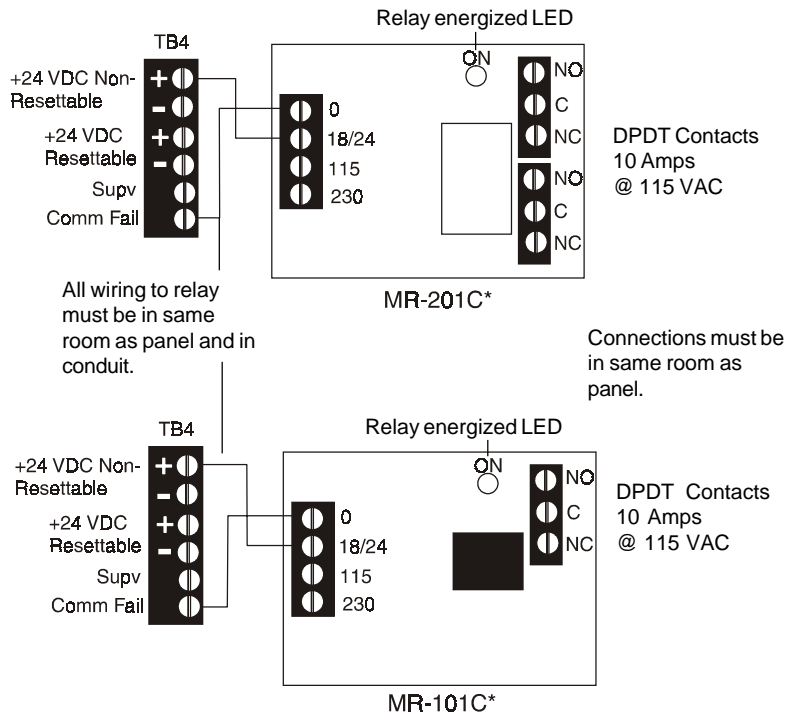

*Note: The MR-101C and MR-201C include an enclosure.

Figure 2-7: Aux Relay and Relay Driver Terminals

2.6 UL Power-limited Wiring Requirements

Power-limited and nonpower-limited circuit wiring must remain separated in the cabinet. All power-limited circuit wiring must remain at least 0.25" away from any nonpower-limited circuit wiring. Furthermore, all power-limited and nonpower-limited circuit wiring must enter and exit the cabinet through different knockouts and/or conduits. A typical wiring diagram for the SA500C is shown below. Refer to Figure 2-15 for additional information on wiring the RM-5F Relay Module.

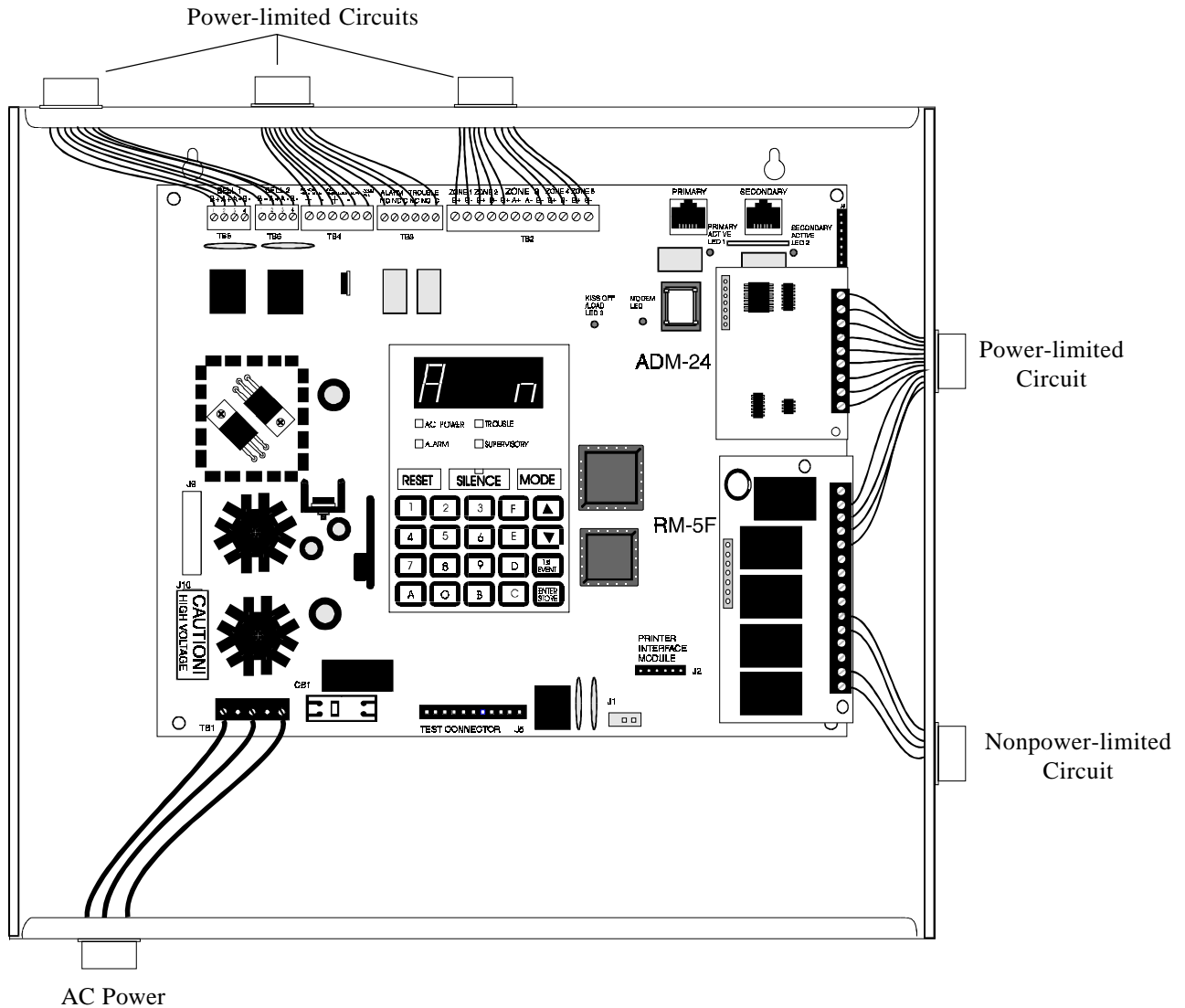

Figure 2-8: Typical Wiring Diagram for UL Power-limited Requirements

2.7 Digital Communicator

Two independent telephone lines can be connected to the control panel. Telephone line control/command is made possible via double line seizure as well as usage of an RJ31X style interconnection. *Note: It is critical that the panel's digital communicator be located as the first device on the incoming telephone circuit to properly function.*

The control panel's digital communicator is built into the main board. Connection and wiring of two phone lines is required as shown below:

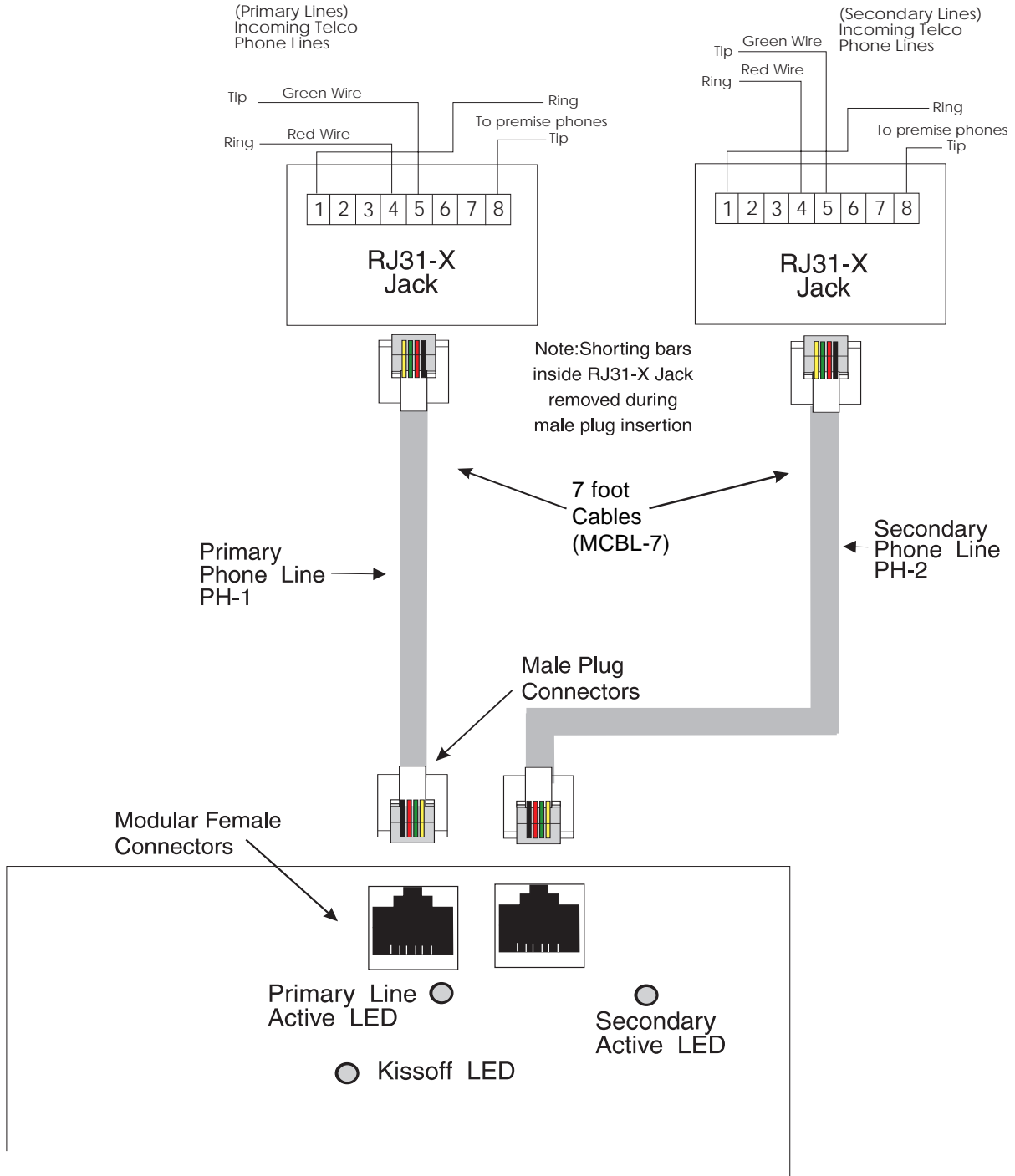

Figure 2-9 : Wiring Phone Jacks

2.8

Optional Boards

ADM-24 Annunciator Driver Module

The Annunciator Driver Module supports the RZA-5F Remote Annunciator. Annunciator wiring is supervised for open conditions by this module. The Annunciator Driver Module mounts to J3 in the upper right corner of the main board.

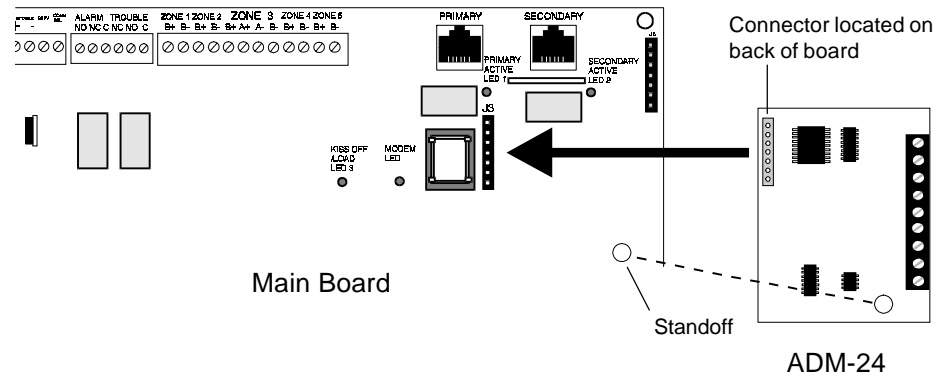

Figure 2-10: ADM-24

The **RZA-5F Remote Annunciator** mounts on a standard single-gang box, and provides LED indication of the following:

- Alarm Zone 1 (red)
- Alarm Zone 2 (red)
- Alarm Zone 3 (red)
- Alarm Zone 4 (red)
- Alarm Zone 5 (red)
- System Trouble (yellow)

The remote annunciator provides individual zone alarm LEDs, a system trouble LED, a piezo sounder and a remote sounder shut off switch.

A Local Trouble Sounder and Silence Switch are also provided. All LEDs and their wiring are supervised for open conditions. Any open condition will cause the System Trouble LED to illuminate.

NOTE: The Remote Annunciator requires the use of an ADM-24 Annunciator Driver Module.

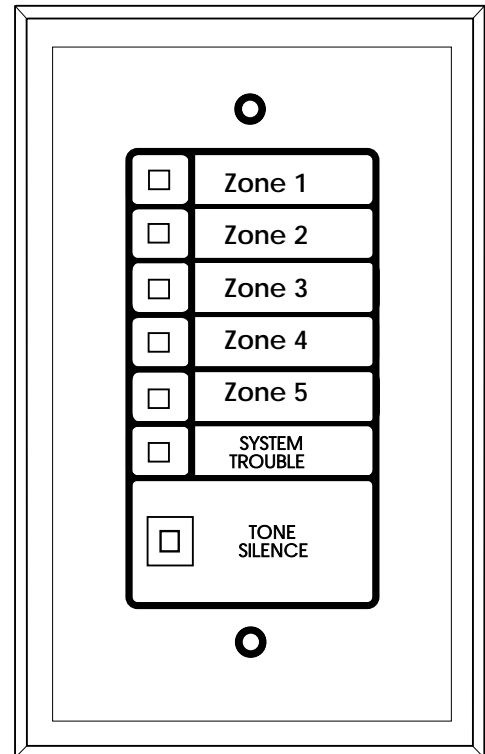

Figure 2-11: RZA-5F

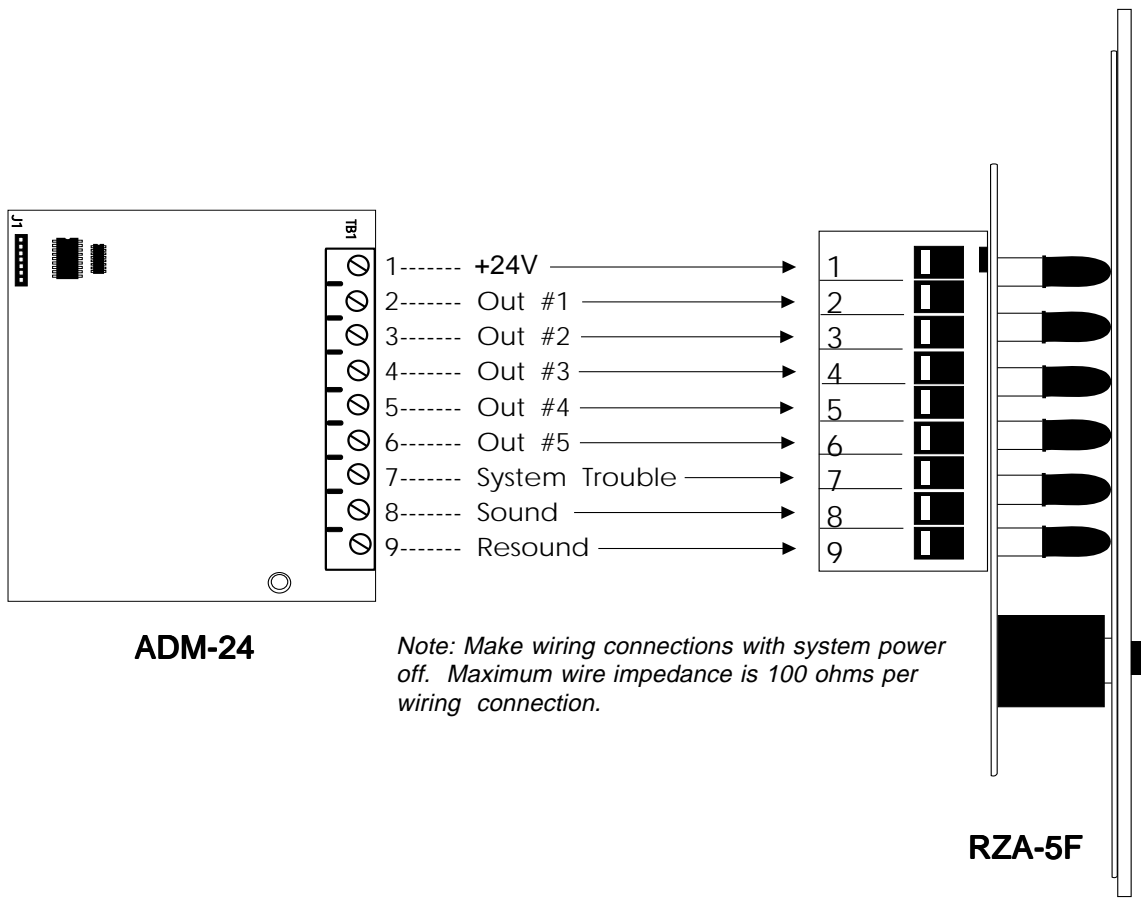

Figure 2-12: Wiring the RZA-5F/ADM-24

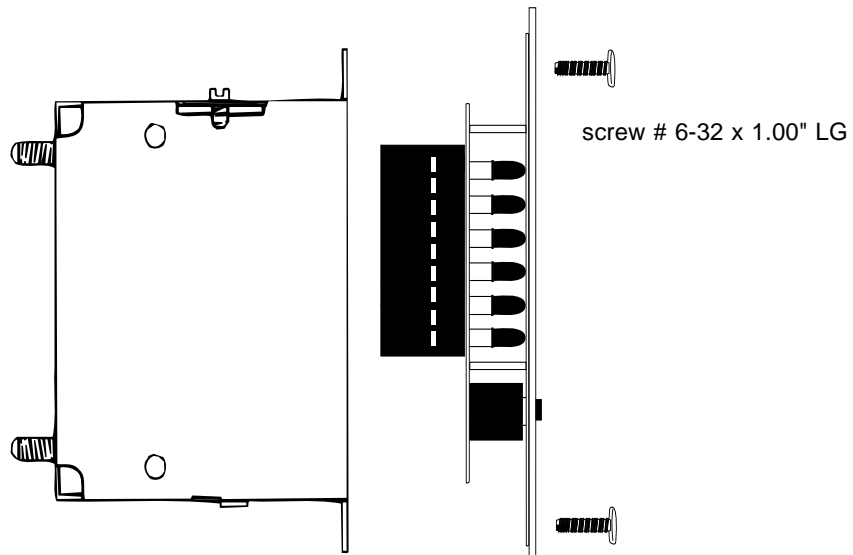

Figure 2-13: Installing the Annunciator (Single Gang Box)

Printer Interface Module

A remote printer may be permanently or temporarily connected to provide a hard-copy printout of normal current system status and activity, program entries, history file, troubleshoot mode voltages, and walktest data. The Printer Interface Module Part Number PRT-24 provides an EIA-232 conversion to adapt to most 40 and 80 column printers.

CAUTION: DO NOT connect a printer to the Fire Alarm Control Communicator if a ground fault exists on the panel. Circuit damage may result.

Installation

Remote printers require separate external primary power. Also required is the PRT-24 which includes the Printer Interface Module and a 6 foot interface cable prewired to a DB25 connector. Connect the interface cable to the PRT-24 as shown in Figure 2-14. Insert the two supplied standoffs into mounting holes near the J2 connector on the main board. Connect the Printer Interface board to J2 on the main circuit board, press onto standoffs, and connect the attached cable to the serial EIA-232 port on the printer. The printer may be placed a maximum of 50 feet from the panel. Note that a ground fault may occur on the control panel when this connection is made. For this reason, it is important that there be no preexisting ground fault on the panel. *For permanent printer connection, a ground fault is not allowed.*

Printer Configuration

The PRT-24 is required. Also refer to the documentation supplied with your printer. Set the printer's options as listed in the table below.

Typical Printer Settings	
Under the MENU area:	
COMMUNIC. SETUP:	
DATA BITS:	7
PARITY:	EVEN
STOP BIT:	1 STOP
BAUD RATE:	2400

J1 located on back of PRT-24 board

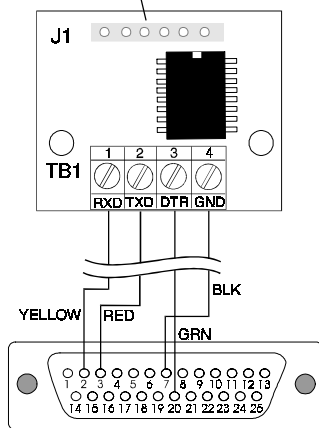

DB-25P Front View

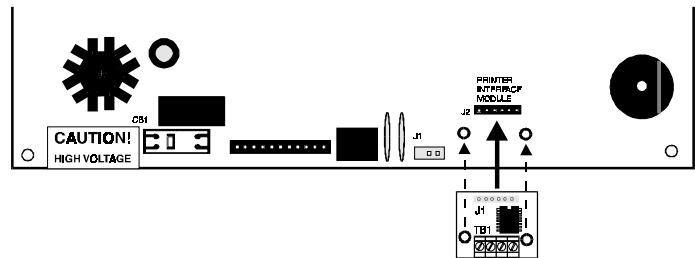

PRT-24 connection to main board

Figure 2-14: Remote Printer Connections

RM-5F Five-Zone Relay Module

The RM-5F option module provides 5 Form-C relays which track zones 1 through 5. The module mounts to connector J7 on the lower right side of the main board as shown in Figure 2-15.

Nonpower-limited and power-limited wiring must have a minimum distance of 0.25" wire to wire. If this module is used to drive nonpower-limited and power-limited circuits, follow the following instructions:

1) Skip a set of dry contacts to maintain the 0.25" required space between power-limited and nonpower-limited circuits. The wiring of this module must follow the requirements as specified above.

OR

2) If this module is needed to drive power-limited and nonpower-limited relays that are next to each other, one relay must be used as an open circuit and the other as a closed circuit as shown in the figure below.

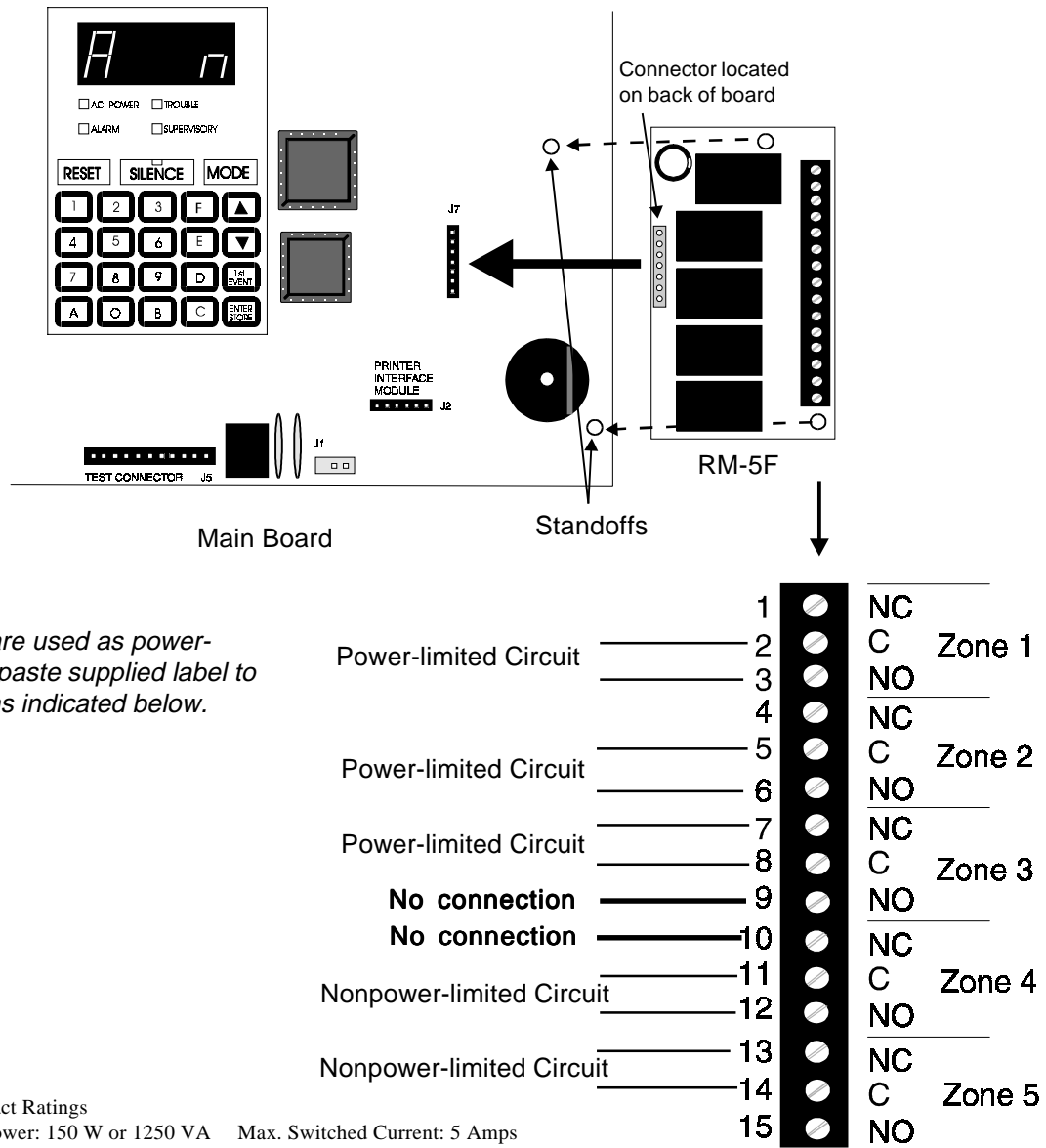
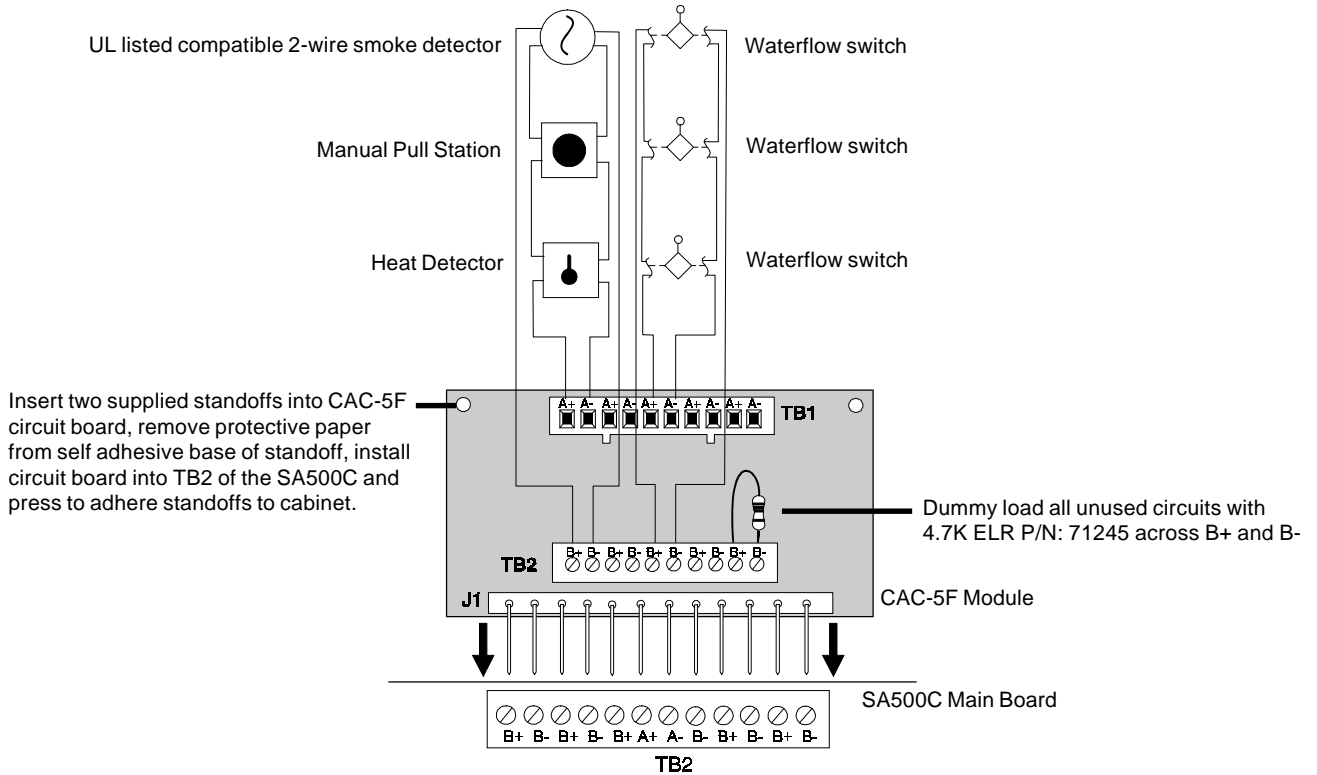

Figure 2-15: RM-5F

CAC-5F

The CAC-5F Class A Converter module converts the Style B (Class B) Initiating Circuits to Style D (Class A). The CAC-5F mounts to terminal block TB2 located in the upper center of the main circuit board (refer to Figure 2-16). The removable terminal block on the CAC-5F module provides for ease of wiring.



- Note: 1) Circuits 1 through 5 can accommodate 2-wire smoke detectors, plus any N.O. contact device such as heat detectors or manual pull stations.
- 2) Only circuit 3 accommodates the non-silenceable waterflow function.

Figure 2-16: CAC-5F Style D Converter

3.0 Programming Instructions

Programming Mode

This section describes programming the panel from the onboard keyboard. Section 7.0 describes remote site upload/download which includes programming the control panel off premises.

Programming of the control panel is possible at any time except when an alarm condition is present or during a fire drill.

The control panel has been designed for many different types of applications. After examining your specific application, review the programming options and choose the entries best suited for your system.

The control panel has a built-in intelligent programmer. All programming selections are stored in nonvolatile Electrically-Erasable Programmable Read-Only Memory (EEPROM). This ensures that the control panel will remember all entries made in programming mode even if both AC and battery power are removed. Invalid entries cause a 'beep' from the onboard piezo sounder.

The user **must** program the primary and secondary phone numbers, account numbers and 24 hour test report times for each Central Station account and the current time and date. The control panel comes with factory chosen options/features already programmed. Other options/features may be programmed if desired. If all factory default settings are acceptable, programming is complete.

3.1 Entering Program Mode

To enter the Program Mode, press the **MODE** key once, (the display will go blank) you then have ten seconds to start entering the code (**7764**).

☛ **7764** spells PROG on a Touch-Tone® phone

If an incorrect key is entered, reenter the proper 4-digit code **before** pressing the **[ENTER/STORE]** key

___7
__77
_776
7764

Note that as you enter information into the control panel, the digits will scroll across the display from right to left

You are allowed a pause of up to 10 seconds in between each number while entering the code. After pressing the **[ENTER/STORE]** key, the control panel will be in Program Mode and display **00_F**. You are allowed up to ten minutes of idle time at this point before starting your programming, otherwise the control panel will go back to Normal Mode. You also have a maximum of 10 minutes between any key stroke. All entries made prior to the 10 minute time-out are valid and are stored.

Once in Programming Mode, the control panel will:

- Blink the trouble LED.
- Activate the trouble relay.
- Disable the Notification Appliance Circuit(s).
- Disable the alarm relay.
- The display shows: **00_F**
- Ignore all other keys other than those mentioned in this section.
- Continue to communicate any events not previously acknowledged at a Central Station prior to entering Programming Mode.

Note: Location 56 is factory defaulted to = 0, Control Panel only. This keeps the communicator off until location 56 is changed to: 1= slave communicator or 2 = panel/communicator. Once location 56 is set to 1 or 2 and a valid phone number is entered, entry into the program mode will cause transmission of the "System off Normal" report.

Throughout programming mode, the first three locations on the left of the display represent the memory address which can go from 00 to 374 (Alpha characters are not used). The last location (farthest right) represents the contents of the memory address. The first address displayed is shown below:

00_F
(address)(data)

3.2 Switch Functions

The Function of each switch in program mode is shown below:

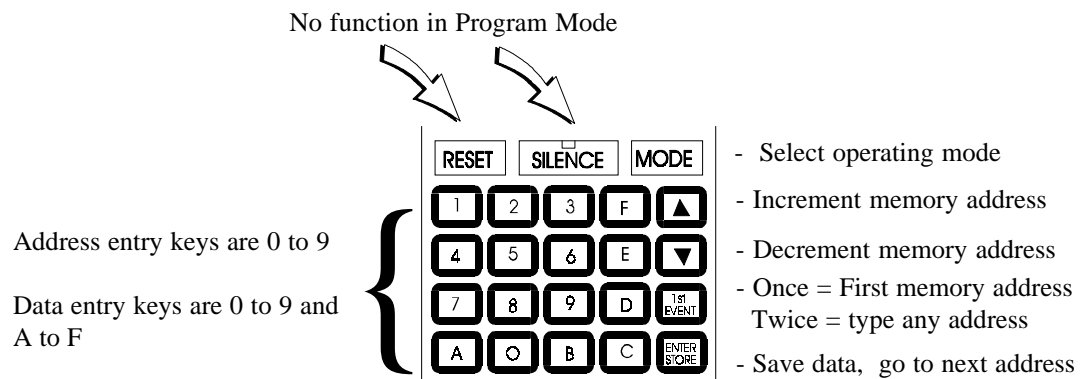

Figure 3-1: Control Panel Keypad

3.3 Programming Options

Primary Central Station phone number. (00-15)

The first sixteen addresses, 00-15, are factory set to 'F' (from **00_F** to **15_F**). Programming is typically done as follows: If your phone # is 484-7161, type **4**, the display will read **00_4**, press **[ENTER/STORE]** to save the entry to memory and increment to the next address **01_F**.

Enter the remaining numbers in their respective addresses as shown below:

4 8 4 7 1 6 1 F F F F F F F F
00 01 02 03 04 05 06 07 08 09 10 11 12 13 14 15 .

Valid entries for both the primary and secondary phone numbers are 0 - F with the numeric digits as dialed numbers and hex digits representing the following functions:

A= * on a Touchtone phone keypad

B= # on a Touchtone phone keypad

C= look for secondary dial tone for up to 2 seconds (then, dial anyway)

D= 3-second pause

E= 5-second pause

F= end of phone number (Note: F must be entered)

Primary Central Station Number Communication Format. (16)

One location is needed to select the Communication Format to the primary phone number. Address 16 is used for this purpose. The default (factory setting) for this address is **16_A**, which is 4+2 Standard, 1800 Hz 'Carrier', 2300 Hz 'ack'. You may enter 0 through D in place of the default, then press **[ENTER/STORE]**. Choose from the list of formats below:

- 0: 4+1 Ademco Express Standard, DTMF, 1400/2300 ACK
- 1: 4+2 Ademco Express Standard, DTMF, 1400/2300 ACK
- 2: 3+1 Standard 1800 Hz Carrier, 2300 Hz ACK
- 3: 3+1 Expanded 1800 Hz Carrier, 2300 Hz ACK
- 4: 3+1 Standard 1900 Hz Carrier, 1400 Hz ACK
- 5: 3+1 Expanded 1900 Hz Carrier, 1400 Hz ACK
- 6: 4+1 Standard 1800 Hz Carrier, 2300 Hz ACK
- 7: 4+1 Expanded 1800 Hz Carrier, 2300 Hz ACK
- 8: 4+1 Standard 1900 Hz Carrier, 1400 Hz ACK
- 9: 4+1 Expanded 1900 Hz Carrier, 1400 Hz ACK
- A: 4+2 Standard 1800 Hz Carrier, 2300 Hz ACK
- B: 4+2 Expanded 1800 Hz Carrier, 2300 Hz ACK
- C: 4+2 Standard 1900 Hz Carrier, 1400 Hz ACK
- D: 4+2 Expanded 1900 Hz Carrier, 1400 Hz ACK
- E: Not Used
- F: Not Used

Note: Consult your Central Station for proper selection or consult our factory representatives. For any format chosen, the control panel automatically programs all of the event codes. See Tables 3-1, 3-2, 3-3, and 3-4.

3+1, 4+1 Express, 4+1 Standard and Expanded, 4+2 Expanded Formats

If '0, 2, 3, 4, 5, 6, 7, 8, 9, B or D' are entered for address 16, the following data is automatically programmed for the Primary Central Station phone number event codes. Enter '0' for the setting to disable the report.

<u>Address</u>	<u>Description</u>	<u>Setting</u>
127	Primary # Zone 1 Alarm Code	1
128	Primary # Zone 2 Alarm Code	1
129	Primary # Zone 3 Alarm Code	1
130	Primary # Zone 4 Alarm Code	1
131	Primary # Zone 5 Alarm Code	1
132	Primary # Zone 1 Disabled Code	F
133	Primary # Zone 2 Disabled Code	F
134	Primary # Zone 3 Disabled Code	F
135	Primary # Zone 4 Disabled Code	F
136	Primary # Zone 5 Disabled Code	F
137	Primary # Drill Code	9
138	Primary # AC Fault Code	F
139	Primary # Zone 1 Fault Code	F
140	Primary # Zone 2 Fault Code	F
141	Primary # Zone 3 Fault Code	F
142	Primary # Zone 4 Fault Code	F
143	Primary # Zone 5 Fault Code	F
144	Primary # Earth Fault Code	F
145	Primary # Low Battery Fault Code	F
146	Primary # No Battery Fault Code	F
147	Primary # Telco Pri. Line Fault Code	F
148	Primary # Telco Sec. Line Fault Code	F
149	Primary # NAC #1 Fault Code	F
150	Primary # NAC #2 Fault Code	F
151	Primary # Comm Trouble Pri. # Code	F
152	Primary # Comm Trouble Sec. # Code	F
153	Primary # Annunciator Fault Code	F
154	Primary # System Off Normal Code	F
155	Primary # Zone 1 Alarm Restore Code	E
156	Primary # Zone 2 Alarm Restore Code	E
157	Primary # Zone 3 Alarm Restore Code	E
158	Primary # Zone 4 Alarm Restore Code	E
159	Primary # Zone 5 Alarm Restore Code	E
160	Primary # Zone 1 Disabled Restore Code	E
161	Primary # Zone 2 Disabled Restore Code	E
162	Primary # Zone 3 Disabled Restore Code	E
163	Primary # Zone 4 Disabled Restore Code	E
164	Primary # Zone 5 Disabled Restore Code	E
165	Primary # Drill Restore Code	9
166	Primary # AC Fault Restore Code	E
167	Primary # Zone 1 Fault Restore Code	E
168	Primary # Zone 2 Fault Restore Code	E
169	Primary # Zone 3 Fault Restore Code	E
170	Primary # Zone 4 Fault Restore Code	E
171	Primary # Zone 5 Fault Restore Code	E
172	Primary # Earth Fault Restore Code	E
173	Primary # Low Battery Fault Restore Code	E
174	Primary # No Battery Fault Restore Code	E
175	Primary # Telco Pri. Line Fault Restore Code	E
176	Primary # Telco Sec. Line Fault Restore Code	E
177	Primary # NAC #1 Fault Restore Code	E
178	Primary # NAC #2 Fault Restore Code	E
179	Primary # Comm Trouble Pri. # Restore Code	E
180	Primary # Comm Trouble Sec. # Restore Code	E
181	Primary # Annunciator Fault Restore Code	E
182	Primary # System Off Normal Restore Code	E
183	Primary # System Test Report	9
184	Primary # System Abnormal Test Report	F
185	Primary # Request for Up/Download	7
186	Primary # Successful Upload	7
187	Primary # Successful Download	7
188	Primary # Failed Up/Download	7

Table 3-1: Event Codes, Primary Central Station Number

4+2 Standard and 4+2 Express Format

If '1, A or C' are entered for address 16, the following data is automatically programmed for the Primary Central Station phone number event codes. Enter '00' for the setting to disable the report.

Address	Description	Settings
127 - 128	Primary # Zone 1 Alarm Code	11
129 - 130	Primary # Zone 2 Alarm Code	12
131 - 132	Primary # Zone 3 Alarm Code	13
133 - 134	Primary # Zone 4 Alarm Code	14
135 - 136	Primary # Zone 5 Alarm Code	15
137 - 138	Primary # Zone 1 Disable Code	F1
139 - 140	Primary # Zone 2 Disable Code	F2
141 - 142	Primary # Zone 3 Disable Code	F3
143 - 144	Primary # Zone 4 Disable Code	F4
145 - 146	Primary # Zone 5 Disable Code	F5
147 - 148	Primary # Drill Code	97
149 - 150	Primary # AC Fault Code	F6
151 - 152	Primary # Zone 1 Fault Code	F1
153 - 154	Primary # Zone 2 Fault Code	F2
155 - 156	Primary # Zone 3 Fault Code	F3
157 - 158	Primary # Zone 4 Fault Code	F4
159 - 160	Primary # Zone 5 Fault Code	F5
161 - 162	Primary # Earth Fault Code	F7
163 - 164	Primary # Low Battery Fault Code	F8
165 - 166	Primary # No Battery Fault Code	F9
167 - 168	Primary # Telco Pri. Line Fault Code	FA
169 - 170	Primary # Telco Sec. Line Fault Code	FB
171 - 172	Primary # NAC #1 Fault Code	FC
173 - 174	Primary # NAC #2 Fault Code	FC
175 - 176	Primary # Comm Trouble Pri. # Code	FD
177 - 178	Primary # Comm Trouble Sec. # Code	FE
179 - 180	Primary # Annunciator Fault Code	FC
181 - 182	Primary # System Off Normal Code	FF
183 - 184	Primary # Zone 1 Alarm Restore Code	E1
185 - 186	Primary # Zone 2 Alarm Restore Code	E2
187 - 188	Primary # Zone 3 Alarm Restore Code	E3
189 - 190	Primary # Zone 4 Alarm Restore Code	E4
191 - 192	Primary # Zone 5 Alarm Restore Code	E5
193 - 194	Primary # Zone 1 Disable Restore Code	E1
195 - 196	Primary # Zone 2 Disable Restore Code	E2
197 - 198	Primary # Zone 3 Disable Restore Code	E3
199 - 200	Primary # Zone 4 Disable Restore Code	E4
201 - 202	Primary # Zone 5 Disable Restore Code	E5
203 - 204	Primary # Drill Restore Code	98
205 - 206	Primary # AC Fault Restore Code	E6
207 - 208	Primary # Zone 1 Fault Restore Code	E1
209 - 210	Primary # Zone 2 Fault Restore Code	E2
211 - 212	Primary # Zone 3 Fault Restore Code	E3
213 - 214	Primary # Zone 4 Fault Restore Code	E4
215 - 216	Primary # Zone 5 Fault Restore Code	E5
217 - 218	Primary # Earth Fault Restore Code	E7
219 - 220	Primary # Low Battery Fault Restore Code	E8
221 - 222	Primary # No Battery Fault Restore Code	E9
223 - 224	Primary # Telco Pri. Line Fault Restore Code	EA
225 - 226	Primary # Telco Sec. Line Fault Restore Code	EB
227 - 228	Primary # NAC #1 Fault Restore Code	EC
229 - 230	Primary # NAC #2 Fault Restore Code	EC
231 - 232	Primary # Comm Trouble Pri. # Restore Code	ED
233 - 234	Primary # Comm Trouble Sec. # Restore Code	EE
235 - 236	Primary # Annunciator Fault Restore Code	EC
237 - 238	Primary # System Off Normal Restore Code	EF
239 - 240	Primary # System Test Report	99
241 - 242	Primary # System Abnormal Test Report	91
243 - 244	Primary # Request for Up/Download	71
245 - 246	Primary # Successful Upload	72
247 - 248	Primary # Successful Download	73
249 - 250	Primary # Failed Up/Download	74

Table 3-2: Event Codes, Primary Central Station Number

Primary Central Station Number Account Code (17-20) Four locations at addresses 17-20 default to all '0's. Valid entries are (0-9 and A-F). The number of digits entered must match the format selection. If programming '2, 3, 4, or 5' into address 16, enter 3 digits. (location 20 is ignored). If programming '0, 1, 6, 7, 8, 9, A, B, C, or D' into address 16, enter 4 digits.

Primary Central Station Number 24 Hour Test Time (21-24).

Use military time when entering the 24 hour 'test' time. The 24 hour test report to phone number 1 takes up four locations, from addresses 21-24. The default is 23:45 (11:45 PM). The limits for each location are as follows: 21: enter 0, 1, 2; 22: enter 0-9; 23 : enter 0-5; 24: enter 0-9. Note: Do not use A-F.

Primary Central Station Number 24/12/8/6 Hour Test Time Interval (25). The test report sent to the Primary phone number may be sent every 6, 8, 12 or 24 hours. If the message is to be sent every 24 hours, leave the factory default entry of zero. If other test report times are needed, enter 1=12, 2=8 and 3=6.

Secondary Central Station Phone Number (26-41). Programming is similar to programming the primary phone number located at addresses 00 - 15. The defaults are also all 'F's.

F F F F F F F F F F F F F F F
26 27 28 29 30 31 32 33 34 35 36 37 38 39 40 41 .

Secondary Central Station Number Communication Format (42). Programming is the same as the primary number's Comm Format at address 16. Default entry is 'A', 4+2 Standard. Choose one entry from the list below:

- 0: 4+1 Ademco Express Standard, DTMF, 1400/2300 ACK
- 1: 4+2 Ademco Express Standard, DTMF, 1400/2300 ACK
- 2: 3+1 Standard 1800 Hz Carrier, 2300 Hz ACK
- 3: 3+1 Expanded 1800 Hz Carrier, 2300 Hz ACK
- 4: 3+1 Standard 1900 Hz Carrier, 1400 Hz ACK
- 5: 3+1 Expanded 1900 Hz Carrier, 1400 Hz ACK
- 6: 4+1 Standard 1800 Hz Carrier, 2300 Hz ACK
- 7: 4+1 Expanded 1800 Hz Carrier, 2300 Hz ACK
- 8: 4+1 Standard 1900 Hz Carrier, 1400 Hz ACK
- 9: 4+1 Expanded 1900 Hz Carrier, 1400 Hz ACK
- A: 4+2 Standard 1800 Hz Carrier, 2300 Hz ACK
- B: 4+2 Expanded 1800 Hz Carrier, 2300 Hz ACK
- C: 4+2 Standard 1900 Hz Carrier, 1400 Hz ACK
- D: 4+2 Expanded 1900 Hz Carrier, 1400 Hz ACK
- E: Not Used
- F: Not Used

3+1, 4+1 Express, 4+1 Standard and Expanded, and 4+2 Expanded Formats

If '0, 2, 3, 4, 5, 6, 7, 8, 9, B or D' are entered for address 42, the following is automatically programmed for the Secondary Central Station phone number event codes. Enter '0' for the setting to disable the report.

<u>Address</u>	<u>Description</u>	<u>Setting</u>
251	Secondary # Zone 1 Alarm Code	1
252	Secondary # Zone 2 Alarm Code	1
253	Secondary # Zone 3 Alarm Code	1
254	Secondary # Zone 4 Alarm Code	1
255	Secondary # Zone 5 Alarm Code	1
256	Secondary # Zone 1 Disabled Code	F
257	Secondary # Zone 2 Disabled Code	F
258	Secondary # Zone 3 Disabled Code	F
259	Secondary # Zone 4 Disabled Code	F
260	Secondary # Zone 5 Disabled Code	F
261	Secondary # Drill Code	9
262	Secondary # AC Fault Code	F
263	Secondary # Zone 1 Fault Code	F
264	Secondary # Zone 2 Fault Code	F
265	Secondary # Zone 3 Fault Code	F
266	Secondary # Zone 4 Fault Code	F
267	Secondary # Zone 5 Fault Code	F
268	Secondary # Earth Fault Code	F
269	Secondary # Low Battery Fault Code	F
270	Secondary # No Battery Fault Code	F
271	Secondary # Telco Pri. Line Fault Code	F
272	Secondary # Telco Sec. Line Fault Code	F
273	Secondary # NAC #1 Fault Code	F
274	Secondary # NAC #2 Fault Code	F
275	Secondary # Comm Trouble Pri. # Code	F
276	Secondary # Comm Trouble Sec. # Code	F
277	Secondary # Annunciator Fault Code	F
278	Secondary # System Off Normal Code	F
279	Secondary # Zone 1 Alarm Restore Code	E
280	Secondary # Zone 2 Alarm Restore Code	E
281	Secondary # Zone 3 Alarm Restore Code	E
282	Secondary # Zone 4 Alarm Restore Code	E
283	Secondary # Zone 5 Alarm Restore Code	E
284	Secondary # Zone 1 Disabled Restore Code	E
285	Secondary # Zone 2 Disabled Restore Code	E
286	Secondary # Zone 3 Disabled Restore Code	E
287	Secondary # Zone 4 Disabled Restore Code	E
288	Secondary # Zone 5 Disabled Restore Code	E
289	Secondary # Drill Restore Code	9
290	Secondary # AC Fault Restore Code	E
291	Secondary # Zone 1 Fault Restore Code	E
292	Secondary # Zone 2 Fault Restore Code	E
293	Secondary # Zone 3 Fault Restore Code	E
294	Secondary # Zone 4 Fault Restore Code	E
295	Secondary # Zone 5 Fault Restore Code	E
296	Secondary # Earth Fault Restore Code	E
297	Secondary # Low Battery Fault Restore Code	E
298	Secondary # No Battery Fault Restore Code	E
299	Secondary # Telco Pri. Line Fault Restore Code	E
300	Secondary # Telco Sec. Line Fault Restore Code	E
301	Secondary # NAC #1 Fault Restore Code	E
302	Secondary # NAC #2 Fault Restore Code	E
303	Secondary # Comm Trouble Pri. # Restore Code	E
304	Secondary # Comm Trouble Sec. # Restore Code	E
305	Secondary # Annunciator Fault Restore Code	E
306	Secondary # System Off Normal Restore Code	E
307	Secondary # System Test Report	9
308	Secondary # System Abnormal Test Report	F
309	Secondary # Request for Up/Download	7
310	Secondary # Successful Upload	7
311	Secondary # Successful Download	7
312	Secondary # Failed Up/Download	7

Table 3-3: Event Codes, Secondary Central Station Number

4+2 Standard and 4+2 Express Formats

If '1, A or C' are entered for address 42, the following is automatically programmed for the Secondary Central Station phone number event codes. Enter '00' for the setting to disable the report.

<u>Address</u>	<u>Description</u>	<u>Setting</u>
251 - 252	Secondary # Zone 1 Alarm Code	11
253 - 254	Secondary # Zone 2 Alarm Code	12
255 - 256	Secondary # Zone 3 Alarm Code	13
257 - 258	Secondary # Zone 4 Alarm Code	14
259 - 260	Secondary # Zone 5 Alarm Code	15
261 - 262	Secondary # Zone 1 Disable Code	F1
263 - 264	Secondary # Zone 2 Disable Code	F2
265 - 266	Secondary # Zone 3 Disable Code	F3
267 - 268	Secondary # Zone 4 Disable Code	F4
269 - 270	Secondary # Zone 5 Disable Code	F5
271 - 272	Secondary # Drill Code	97
273 - 274	Secondary # AC Fault Code	F6
275 - 276	Secondary # Zone 1 Fault Code	F1
277 - 278	Secondary # Zone 2 Fault Code	F2
279 - 280	Secondary # Zone 3 Fault Code	F3
281 - 282	Secondary # Zone 4 Fault Code	F4
283 - 284	Secondary # Zone 5 Fault Code	F5
285 - 286	Secondary # Earth Fault Code	F7
287 - 288	Secondary # Low Battery Fault Code	F8
289 - 290	Secondary # No Battery Fault Code	F9
291 - 292	Secondary # Telco Pri. Line Fault Code	FA
293 - 294	Secondary # Telco Sec. Line Fault Code	FB
295 - 296	Secondary # NAC #1 Fault Code	FC
297 - 298	Secondary # NAC #2 Fault Code	FC
299 - 300	Secondary # Comm Trouble Pri. # Code	FD
301 - 302	Secondary # Comm Trouble Sec. # Code	FE
303 - 304	Secondary # Annunciator Fault Code	FC
305 - 306	Secondary # System Off Normal Code	FF
307 - 308	Secondary # Zone 1 Alarm Restore Code	E1
309 - 310	Secondary # Zone 2 Alarm Restore Code	E2
311 - 312	Secondary # Zone 3 Alarm Restore Code	E3
313 - 314	Secondary # Zone 4 Alarm Restore Code	E4
315 - 316	Secondary # Zone 5 Alarm Restore Code	E5
317 - 318	Secondary # Zone 1 Disable Restore Code	E1
319 - 320	Secondary # Zone 2 Disable Restore Code	E2
321 - 322	Secondary # Zone 3 Disable Restore Code	E3
323 - 324	Secondary # Zone 4 Disable Restore Code	E4
325 - 326	Secondary # Zone 5 Disable Restore Code	E5
327 - 328	Secondary # Drill Restore Code	98
329 - 330	Secondary # AC Fault Restore Code	E6
331 - 332	Secondary # Zone 1 Fault Restore Code	E1
333 - 334	Secondary # Zone 2 Fault Restore Code	E2
335 - 336	Secondary # Zone 3 Fault Restore Code	E3
337 - 338	Secondary # Zone 4 Fault Restore Code	E4
339 - 340	Secondary # Zone 5 Fault Restore Code	E5
341 - 342	Secondary # Earth Fault Restore Code	E7
343 - 344	Secondary # Low Battery Fault Restore Code	E8
345 - 346	Secondary # No Battery Fault Restore Code	E9
347 - 348	Secondary # Telco Pri. Line Fault Restore Code	EA
349 - 350	Secondary # Telco Sec. Line Fault Restore Code	EB
351 - 352	Secondary # NAC #1 Fault Restore Code	EC
353 - 354	Secondary # NAC #2 Fault Restore Code	EC
355 - 356	Secondary # Comm Trouble Pri. # Restore Code	ED
357 - 358	Secondary # Comm Trouble Sec. # Restore Code	EE
359 - 360	Secondary # Annunciator Fault Restore Code	EC
361 - 362	Secondary # System Off Normal Restore Code	EF
363 - 364	Secondary # System Test Report	99
365 - 366	Secondary # System Abnormal Test Report	91
367 - 368	Secondary # Request for Up/Download	71
369 - 370	Secondary # Successful Upload	72
371 - 372	Secondary # Successful Download	73
373 - 374	Secondary # Failed Up/Download	74

Table 3-4: Event Codes, Secondary Central Station Number

Secondary Central Station Number Account Code (43-46) is programmed in addresses 43 - 46 in the same manner as the primary phone number Account Code. Default entries are all '0s'.

Secondary Central Station Number 24-Hour Test Time (47-50) is programmed in addresses 47-50 in the same manner as the primary number 24-Hour Test Time. Default is 0000 (12:00 midnight).

Secondary Central Station Number 24/12/8/6 Hour Test Time (51) The test message sent to the Secondary phone number may be sent every 6, 8, 12 or 24 hours. If the message is to be sent every 24 hours, leave the factory default entry of zero. If other test report times are needed, enter 1=12, 2=8 and 3=6.

Alarm Verification (52)

Alarm verification works only on zones programmed as 2-wire smoke detector zones. After detecting an alarm, the panel removes power from all zones for 6 seconds, resetting all 2-wire smoke detectors. Power is reapplied and a 12 second retard period allows detectors to stabilize. During the retard/reset period of 18 seconds, subsequent alarms by the same initiating zone are ignored. An alarm detected on any other 2-wire detector zone during the retard period will cause immediate verified alarms. A subsequent alarm on the initiating zone occurring within the confirmation time will cause a verified alarm. **Note:** *Mixing devices on zones designated as 2-wire smoke zones is not recommended.*

During the alarm verification period, access to other modes of operation is prevented.

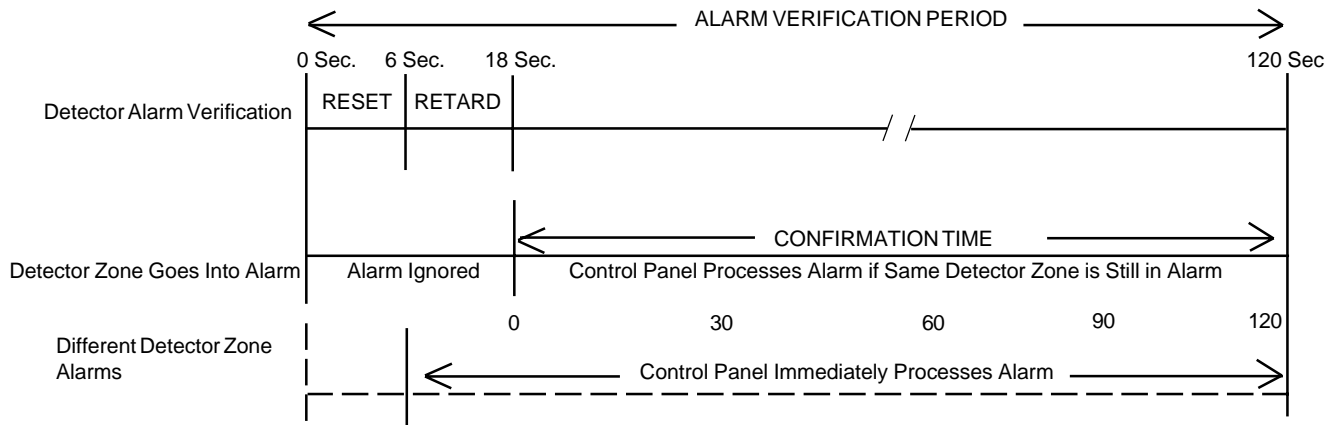

Figure 3-2: Verification Timing Diagram

Factory Default selection is no verification which is '0'. Entering a '1' enables verification. *Note: Consult local Authority Having Jurisdiction (AHJ) prior to altering this address.*

Future Use (53-55)

Slave Communicator/Fire Panel Selection (56)

Leaving address 56 at '0' causes the control panel to operate as a *fire panel only*. Selecting '1' will make it operate as a *slave communicator only*. Selecting '2' will make it operate as a *Fire panel/communicator*.

Zones 1-5 Function Selection (57-61)

The five zones on the control panel may be programmed as shown below. Program entries alter zone function and transmittal priority.

<u>Program Entry</u>	<u>Function</u>
0	Operates 2-wire smoke detectors
1	Pull Station
2	Normally Open Contact Device
3	Supervisory
4	Supervisory, auto-resettable. Self restore function, is not latched by the control panel.
5	Waterflow, silenceable. Silencing of Silenceable Notification Appliance Circuits allowed. Affects zone 3 only.
6	Waterflow, non-silenceable. Silencing of Silenceable Notification Appliance Circuits not allowed. Must clear waterflow alarm condition and press reset key. Affects zone 3 only.

Zone 1 Function Selection (57)

Factory default for zone 1 is '0', 2-wire smoke detector. Enter 1 for pull station, 2 for Normally Open contact device, 3 for Supervisory or 4 for Supervisory, auto resettable.

Zone 2 Function Selection (58)

Factory default for zone 2 is '0', 2-wire smoke detector. Enter 1 for pull station, 2 for Normally Open contact device, 3 for Supervisory or 4 for Supervisory auto resettable.

Zone 3 Function Selection (59)

Factory default for zone 3 is '0', 2-wire smoke detector. Enter 1 for pull station, 2 for Normally Open contact device, 3 for Supervisory or 4 for Supervisory auto resettable, 5 for Waterflow silenceable or 6 for Waterflow non-silenceable.

Zone 4 Function Selection (60)

Factory default for zone 4 is '0', 2-wire smoke detector. Enter 1 for pull station, 2 for Normally Open contact device, 3 for Supervisory or 4 for Supervisory auto resettable.

Zone 5 Function Selection (61)

Factory default for zone 5 is '0', 2-wire smoke detector. Enter 1 for pull station, 2 for Normally Open contact device, 3 for Supervisory or 4 for Supervisory auto resettable.

Note: Programming any zone to function as supervisory or supervisory auto-resettable will cause the defaulted event codes (note in Tables 3-1 through 3-4) to be automatically changed. The defaulted code of '1' is changed to '8' for formats 3+1 and 4+1 Standard and Expanded, 4+2 Expanded and 4+1 Express. The defaulted codes of 11, 12, 13, 14, and 15 are changed to 81, 82, 83, 84, and 85 accordingly for formats 4+2 Standard and 4+2 Express.

Waterflow Retard Timer (62-63)

A delay may be added prior to declaring a Waterflow type of alarm. Delays up to 89 seconds are allowed. The default for addresses 62 and 63 are '00' (no additional delay). Valid keys for 62 are 0-8 and for 63, 0-9. Program an entry into this address only if entering a '5 or 6' in address 59. *Be careful to include any built in delays of the waterflow device.*

AC Loss Reporting Delay (64) Enter a digit of 1-F corresponding to the number of hours to be delayed in reporting loss of AC power. Factory default is 6-hour delay. If 24 hour battery backup is being employed, select from choices 0-6. If 60 hour battery backup is used, select from choices 7-F. Selections are: 0=6 hours, 1=7 hours, 2=8 hours, 3=9 hours, 4=10 hours, 5=11 hours, 6=12 hours, 7=15 hours, 8=16 hours, 9=17 hours, A=18 hours, B=19 hours, C=20 hours, D=21 hours, E=22 hours and F=23 hours.

Alarm Presignal (65)

Alarm Presignal is used to delay Notification Appliance Circuit(s) activation while allowing for visual verification by a person. Once a zone triggers an alarm, the mainboard piezo and the annunciator piezo turn on steady, the display indicates the activated zone, the alarm LED blinks, and the Notification Appliance Circuits are held off for 15 seconds. During this time, if the silence switch is pressed, the Notification Appliances may be held off for up to 3 minutes. (See Presignal Delay Timer Address 66-68). After the programmed delay period, the Notification Appliances will activate. *Presignal does not function for zones defined as Waterflow or Supervisory.* Factory default is '0' for no alarm presignal. Enter '1' to select alarm presignal. During alarm presignal, access to other modes is prevented.

Alarm Presignal Delay Timer (66-68)

The alarm presignal timer is factory set to 120 seconds (2 minutes), address 66=1, 67=2 and 68=0. The timer may be programmed from 0 to 179 seconds. Location 65 must be set to '1'.

Notification Appliance Circuit #1 Enable (69)

Notification Appliance Circuit #1 may be programmed as 0=silenceable, 1=non-silenceable or 2=disabled. Factory default is '0', silenceable. *Note: Consult local Authority Having Jurisdiction (AHJ) prior to altering this address.*

Silence Inhibit Notification Appliance Circuit #1 (70)

Setting address number 70 equal to '1' prohibits silencing of Notification Appliance Circuit #1 and the on board piezo for 1 minute. Factory default is zero, no silence inhibit of Notification Appliance Circuit #1.

Auto Silence Notification Appliance Circuit #1 (71)

Notification Appliance Circuit #1 may be auto-silenced after a programmed time interval between 5 and 30 minutes. Enter 1=5 minute autosilence, 2=10 minutes, 3=15 minutes, 4=20 minutes, 5=25 minutes and 6=30 minutes. The factory default is '0' no autosilence.

Coding, Notification Appliance Circuit #1 (72)

Coding of Notification Appliance Circuit #1 is selectable for 1=March Time (120ppm), 2=California (10 seconds on, 5 seconds off) or 3=Temporal (.5 seconds on, .5 seconds off, .5 seconds on, .5 seconds off, .5 seconds on, 1.5 seconds off) Factory default is '0', steady, no coding.

Notification Appliance Circuit #2 Enable (73)

Notification Appliance Circuit #2 may be programmed as 0=silenceable, 1=non-silenceable or 2=disabled. Factory default is '0', silenceable. *Note: Consult local Authority Having Jurisdiction (AHJ) prior to altering this address.*

Silence Inhibit Notification Appliance Circuit #2 (74)

Setting address number 74 equal to '1' prohibits silencing of Notification Appliance Circuit #1 and the on board piezo for 1 minute. Factory default is zero, no silence inhibit of Notification Appliance Circuit #2.

Auto Silence Notification Appliance Circuit #2 (75)

Notification Appliance Circuit #2 may be auto-silenced after a programmed time interval between 5 and 30 minutes. Enter 1=5 minute autosilence, 2=10 minutes, 3=15 minutes, 4=20 minutes, 5=25 minutes and 6=30 minutes. The factory default is '0' no autosilence.

Coding, Notification Appliance Circuit #2 (76)

Coding of Notification Appliance Circuit #2 is selectable for 1=March Time (120ppm), 2=California (10 seconds on, 5 seconds off) or 3=Temporal (.5 seconds on, .5 seconds off, .5 seconds on, .5 seconds off, .5 seconds on, 1.5 seconds off) Factory default is '0', steady, no coding.

Trouble Reminder (77) Factory default '0' disables the trouble reminder feature. Selecting '1' will cause a reminding beep (after the silence switch is pressed) every 15 seconds during an alarm and beep every two minutes during a trouble condition. The beeps from the on board piezo sounder will occur until the alarm or fault is cleared.

Annunciator/Printer Supervision (78) Factory default is '0' no annunciator or printer present. Set address 78 to a '1' if an annunciator is present, set to a '2' if a printer is present and set to a '3' if both an annunciator and a printer are present.

Backup Reporting (79) Leaving address 79 at '0' means that reports will be transmitted to the secondary Central Station phone number only if attempts to communicate to the primary Central Station phone number are unsuccessful. Programming a '1' causes all reports to be transmitted to the secondary Central Station phone number.

Touchtone/Rotary Select (80) A '0' programmed in this address by the factory triggers Touchtone dialing over both phone lines. Select '1' for rotary dialing.

Make Break Ratio (81) Use this address only if you have chosen '1' for address 80. The make/break ratio is factory set to '0' which is 67/33, but may be changed to '1' which is a 62/38 ratio.

Address (82) - Leave default of 0.

Address (83) - Leave default of 0.

Panel Identification Number (84-87)

The Panel Identification Number is a 4-digit code (valid digits being 0 - F) that is used to identify the installed panel. This code is separate from the 8-digit secret code loaded in by the Service Terminal. It is important to program this 4-digit code at the jobsite the first time that downloading is performed so that the called Service Terminal can identify the control panel.

Service Terminal Number 1 Phone Number (88-103)

Addresses 88 through 103 are reserved for the Service Terminal Number 1 phone number. Factory default is all Fs. Valid entries are 0-9 plus A, B, C, D, and E, similar to the primary and secondary Central Station phone number entries programmed at addresses 00-15 and 26-41. Use 'F' to designate the end of the phone number.

Ring Count on Primary Phone Line (104-105)

Use this address to designate the number of rings allowed on the primary phone line prior to answering an incoming call from a Service Terminal. Factory default is **03** meaning the panel will not answer an incoming call until 3 rings are detected. This entry may be programmed up to a maximum of **25** rings. A setting of **00** prevents the panel from answering incoming calls.

FAX/Answer Machine, Primary Phone Line (106)

This entry is used when the primary phone line is being shared with a FAX, answering machine or other device. Factory default is '0', no sharing of the primary phone line. An entry of '1' allows the panel to wait for three consecutive calls from the Service Terminal spaced 30 seconds apart, before responding.

Service Terminal Number 2 Phone Number (107-122)

Addresses 107 through 122 are reserved for the Service Terminal Number 2 phone number. Factory default is all Fs. Valid entries are 0-9, A, B, C, D, and E, similar to the primary and secondary Central Station phone number entries. Use 'F' to designate the end of the phone number.

Ring Count on the Secondary Phone Line (123-124)

Use this address to designate the number of rings allowed on the secondary phone line prior to answering an incoming call from a Service Terminal. Factory default is **03** meaning the panel will not answer an incoming call until 3 rings are detected. This entry affects the secondary phone line only. This entry may be programmed up to a maximum of **25** rings. A setting of **00** prevents the panel from answering incoming calls.

FAX/Answer Machine, Secondary Phone Line (125)

Factory default is '0' for no sharing of the secondary phone line with a FAX, answering machine or other device. An entry of '1' allows the panel to wait for three consecutive calls spaced 30 seconds apart from the Service Terminal before responding.

Upload/Download Reports Sent to Secondary Central Station Phone #, Backup or Always (126)

Reports for request for 'up/download', 'successful upload', 'successful download', and 'failed up/download' are always sent to the primary Central Station phone number. This entry allows for the same reports to either always be sent to the secondary Central Station phone number or only if attempts to transmit to the primary Central Station phone number are unsuccessful. Factory default is '0' for backup only. Enter '1' for always.

Programming Event Codes (127-374)

The type of reports and 'event codes' that are sent to the Central Station are in the preceding Tables. The selections made for the Primary Central Station Number Communication Format (address 16) and the Secondary Central Station Number Communication Format (address 42) automatically program addresses 127-374 with factory default selections.

Any of the event codes may be changed. *Consult your Central Station prior to altering the event codes.* Entering an event code of '0' will cause the communicator to NOT transmit the report. For the 3+1, 4+1 and 4+1 Express formats or the 4+2 expanded format enter a single zero. For the 4+2 standard or 4+2 Express formats enter two zeros. Transmission of reports to *either or both* Central Station phone numbers may be disabled.

Note the special 'System Abnormal Test Report' event code. This report was added per new UL DACT requirements. This report is generated in place of the normal test report when an alarm and/or trouble condition exists at the time the test report is due to be sent.

Programming the Real-Time Clock and Calendar

Entering an address greater than 374 will cause a display of the current time. On initial power up, the clock will start running from the factory setting of 00:01 (military time). The far left digit will be flashing, indicating that this is the first digit to be programmed.

Hours/Minutes

Select a digit then press **[ENTER/STORE]**. The digit 2nd from the left will start flashing. Select a digit then press **[ENTER/STORE]**. Hours setting is complete. With the digit 2nd from the right flashing, select a digit then press **[ENTER/STORE]**. The digit on the far right will start flashing. Select a digit then press **[ENTER/STORE]**. Minutes setting is complete.

Year

After entering the last digit corresponding to minutes (far right digit) the display will read 1994 with the digit 9, second from the right, flashing. Press **[ENTER/STORE]** if acceptable or any digit. Repeat for digit to far right.

Month/Day

After the year is entered the display will show four digits representing the month and day of the software release date. The month is represented by the two digits on the left and the day by the two digits on the right. The digit on the far left will be flashing. The month and day are set the same way as the hours and minutes. Once the last digit corresponding to the day is entered, the display will show the contents of address '00'. The real time clock/calendar keeps track of leap years automatically. *Note that the software for the SA500C operates the internal clock based upon 60HZ.*

End Programming

Exit Programming Mode by pressing **MODE**, followed by the 4-digit code corresponding to an alternate mode of operation, then press **[ENTER/STORE]**. During Program Mode, if no key is pressed within 10 minutes, the panel will revert to normal mode.

3.4 Default Programming

All program entries can be returned to their factory original settings only when the system is idle in Normal standby condition. Press the **MODE** key, enter the four digit code **3337** and press the **[ENTER/STORE]** key.

☛ **3337** spells DEFP (**DE**fault **P**rogramming) on a Touch-Tone® phone. If an incorrect key is pressed, reenter the proper 4-digit code before pressing the **[ENTER/STORE]** key.

Within five seconds, repeat this entry by again pressing the **MODE** key followed by the 4-digit code **3337** and pressing the **[ENTER/STORE]** key. The display will read **3337** while the E² nonvolatile memory (storage area for all programming options) is being reprogrammed with the original default settings. When reprogramming is complete, the display will be blank.

4.0 Operating Instructions

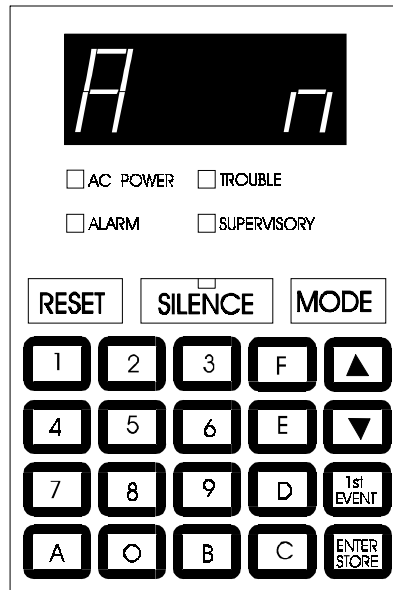

Normal Mode The SA500C has six Modes of operation; Normal, Program, Walk Test, Troubleshoot, History and Print. *Upon initial power up, the system will be in Normal Mode. This section discusses operation of the control panel in the Normal Mode.*

4.1 Switches Below is a description of the function switches in Normal Mode:

RESET The Reset Switch resets the system and any smoke detectors. If the Reset Switch is pressed, the control panel will:

- Clear the display and status LEDs
- Turn off the Notification Appliance Circuits
- Reset all zones by temporarily removing power
- Silence the on board piezo sounder
- Store 'reset' message in the History file
- Restore the Alarm and Trouble relays to normal
- Clear the Supervisory and Communication Fail relay driver outputs
- Temporarily remove power from the resettable power output TB4 terminals 3+4.
- Restore to normal the RM-5F Zone relays.
- Output 'reset' message to printer.

Any alarm, supervisory or trouble condition that exists after a system reset, will resound the system, reactivating normal system activity.

Upon release of the Reset Switch, the display will read **rES_** for six seconds.

SILENCE

If the Silence Switch is pressed:

- The silenceable Notification Appliance Circuits will be turned OFF.
- The silence LED will be turned ON.
- The piezo sounder will be shut OFF.
- 'System Silenced' message will be stored in the History file.
- 'System Silenced' message will be sent to the printer.
- System Silence switch acts as acknowledge switch during alarm presignal.

Upon the occurrence of a subsequent event (alarm or trouble), System Silence is overridden and the control panel will respond to the new event. *The System Silence switch will be ignored for silenceable waterflow type alarms.*

MODE

Pressing the Mode Switch followed by a valid 4-digit numerical code and [ENTER/STORE] selects one of the six modes of operation.

- ☛ To enter normal mode from any other mode press **MODE** then **6676** [ENTER/STORE]. **6676** spells NORM on a Touch-Tone® phone.

1st EVENT

This switch along with the Up Arrow and Down Arrow keys, is used to display any **presently** active alarm and/or fault conditions present in the system. Press the 1st Event switch at any time to display the first event (alarm and/or trouble) that occurred.

DOWN ARROW

Use the Down Arrow key to view other events (older) that have occurred and are active - not cleared yet.

UP ARROW

Use the Up Arrow key to view other events (newer), that have occurred and are active - not cleared yet.

[ENTER/STORE]

See individual mode descriptions in other sections of this manual.

4.2

Displays

Four 7-segment red LED characters provide visual annunciation of status, events and messages. A list of messages that may appear on the display in normal mode is shown below:

d__1	Zone 1 Disabled	F__4	Trouble Zone 4
d__2	Zone 2 Disabled	F__5	Trouble Zone 5
d__3	Zone 3 Disabled	F__A	Annunciator Fault
d__4	Zone 4 Disabled	F__E	Earth Fault
d__5	Zone 5 Disabled	Lo_b	Low Battery
E__1	Zone 1 Enabled	no_b	No Battery
E__2	Zone 2 Enabled	PH_1	Primary C. S. Number Communication Fault
E__3	Zone 3 Enabled	PH_2	Secondary C. S. Number Communication Fault
E__4	Zone 4 Enabled	bEL1	Bell 1 Fault
E__5	Zone 5 Enabled	bEL2	Bell 2 Fault
A__1	Alarm Zone 1	no_1	Primary Phone Line Fault
A__2	Alarm Zone 2	no_2	Secondary Phone Line Fault
A__3	Alarm Zone 3	SUP1	Supervisory Alarm Zone 1
A__4	Alarm Zone 4	SUP2	Supervisory Alarm Zone 2
A__5	Alarm Zone 5	SUP3	Supervisory Alarm Zone 3
F__1	Trouble Zone 1	SUP4	Supervisory Alarm Zone 4
F__2	Trouble Zone 2	SUP5	Supervisory Alarm Zone 5
F__3	Trouble Zone 3	_AC_	AC Power Loss
rES_	System Reset		

Individual LEDs are provided for:

System Alarm—A red LED that turns on steady when an alarm condition is detected and blinks during alarm presignal period.

System Trouble—This yellow LED blinks to indicate that a fault or abnormal condition exists and that the fire alarm system may be inoperative. It turns on steady when the silence switch is pressed.

AC Power On—A green LED that remains on while the A.C. power supply is within correct limits. *If this indicator fails to light under normal conditions, service the system immediately.*

Supervisory—A yellow LED that blinks to indicate the need for action in connection with the supervision or maintenance of sprinklers, extinguishing systems or other protective systems.

System Silence—A yellow LED that turns on to indicate that an Alarm or Trouble condition exists in the system, but both Notification Appliance Circuits (if programmed as silenceable) and local piezo have been silenced.

Primary Line Active—A red LED that indicates the primary phone line is active.

Secondary Line Active—A red LED that indicates the secondary phone line is active.

Kiss-Off —A green LED that blinks when a Central Station has acknowledged receipt of each transmitted message or when a portion of up or downloaded data has been accepted from a Service Terminal.

Modem —A green LED that stays on steady during modem types of communications.

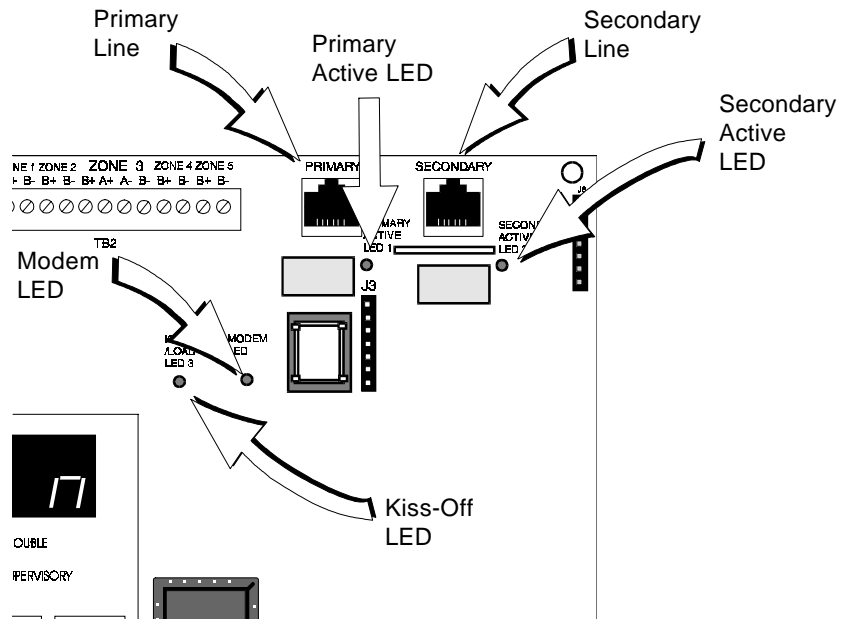

Figure 4-1: Phone Connectors and LEDs

4.3

Operation

Normal mode is the standard mode of operation. In this mode, the panel continuously monitors system status. When no alarm or trouble conditions exist, the display will be blank and all LEDs will be off (except the AC Power LED). The Notification Appliance Circuits will be off, all relays and relay drivers are normal and the onboard piezo sounder will be off. (The communicator is not active, primary and secondary active LEDs are off).

All alarm and system trouble conditions are annunciated on the control panel's display. The control panel will maintain an 'active event list' which will consist of all alarms, supervisory alarms and system troubles currently active, and not cleared, requiring immediate service. When the system is cleared and restored to normal, the display will be blank. All alarms and troubles are stored in a history file and may be recalled at any time.

Higher priority events take precedence over lower priority events. Display and reporting of System Status is done on a priority basis. Priorities are, from highest to lowest:

1. Alarms
2. Supervisory Alarms
3. System Troubles

If the events to be displayed consist of alarms and disabled zones only, (no troubles), the control panel will scroll them on the display. Pressing the 1st Event key will stop the scrolling and cause display of the *First* alarm that occurred after the panel was last reset, cleared of all active events and placed into normal mode. Operation of the Up and Down arrow keys will display all remaining events in sequence.

If events to be displayed include system troubles, only one event is displayed at a time and there is no scrolling. The event displayed is the highest priority. Pressing the 1st Event key will cause the display of the first event that occurred after the panel was last reset, cleared of all active events and placed into normal mode. Operation of the Up and Down arrow keys will display all remaining events in order of their occurrences.

4.3.1 Alarm Response

The control panel will, upon detection of an alarm condition:

- Turn the alarm LED on.
- Activate the alarm relay.
- Display the alarm message, for example, **A__1** Alarm on zone 1.
- Communicate the alarm to the central station.
- Store the alarm in the History file.
- Turn the Notification Appliance Circuits on.
- Turn the Piezo Sounder on.
- Turn on appropriate zone relay output.
- Output alarm message to printer.
- Terminate upload or download communications

Note that when any zone is programmed as a supervisory zone, it will not be processed in the same manner as a conventional alarm zone. **See Supervisory Condition later in this section.**

4.3.2 Alarm Restoral

The control panel only returns to normal after all alarms have been cleared and the Reset switch has been pressed (pull stations reset, smoke detectors reset and no smoke is present, waterflow has stopped). The control panel will perform the following upon restoral of all active alarms:

- Turn off the alarm LED.
- Deactivate the alarm relay.
- Clear the 4-character display .
- Send all 'Zone Restoral' messages to the central station.
- Turn off the Notification Appliance Circuits.
- Turn off the Piezo Sounder.
- Turn off appropriate zone relay output.
- Output alarm restoral message to printer.
- Terminate upload or download communications

4.3.3 System Supervisory Condition Response

Program zones for Supervisory in applications where a waterflow sensing device has been employed and the wiring to the waterflow valve and/or a tamper switch is to be monitored. If the tamper switch has been activated (Normally Open contacts close), a supervisory alarm condition will occur.

When a supervisory condition occurs, the control panel will:

- Blink the supervisory LED (.5 seconds on, .5 seconds off).
- Activate the supervisory relay driver. (TB4-5)
- Display the following message: (SUPX) (X=Zone Number).
- Communicate the supervisory condition to the central station.
- Store the 'supervisory' message in the History file.
- Pulse the piezo sounder at 0.5 sec on 0.5 sec off rate.
- Turn on appropriate zone relay output.
- Output system supervisory message to printer.
- Terminate upload or download communications

4.3.4 System Supervisory Restoral Response

When the supervisory condition has been cleared (condition is restored and the reset switch has been pressed) the control panel will perform the following:

- Turn off the supervisory LED.
- Deactivate the supervisory relay driver (TB4-5).
- Clear the display of the 'SUP' message.
- Communicate a supervisory restoral message to the central station.
- Shut off the piezo sounder.
- Turn off appropriate zone relay output.
- Output system supervisory restoral message to printer.
- Terminate upload or download communications

Note: For any zone programmed for Supervisory auto resettable, the Reset key does not need to be pressed to clear the zone (Supervisory condition).

4.3.5 Trouble Condition Response

The control panel will perform the following upon detection of one or more trouble conditions:

- Blink the trouble LED (one second on, one second off).
- Activate the trouble relay.
- Display the appropriate trouble message(s) in priority fashion from the highest priority to the lowest. **Note:** (Must press Up Arrow, Down Arrow, or 1st Event key to view).
- Communicate the trouble conditions to the central station.
- Store the trouble conditions in the history file.
- Sound the piezo sounder one second on, one second off.

- Output the system trouble messages to the printer.
- Terminate upload or download communications

Note: When AC Brownout occurs the AC LED is turned off, and the Trouble LED blinks. Should the brownout condition remain, it will be transmitted to the central station after a delay (See Program Address number 64).

Possible trouble messages that may appear on the display are as follows:

<u>_AC_</u>	AC Loss (shown only when requested)		
d_1	Zone 1 disabled	F_E	Ground fault
d_2	Zone 2 disabled	Lo_b	Low battery
d_3	Zone 3 disabled	no_b	No battery
d_4	Zone 4 disabled	no_1	Primary Phone Line Fault
d_5	Zone 5 disabled	no_2	Secondary Phone Line Fault
F_1	Trouble on zone 1	bEL1	Bell 1 circuit fault
F_2	Trouble on zone 2	bEL2	Bell 2 circuit fault
F_3	Trouble on zone 3	PH_1	Primary C. S. Number Communi- cation Fault
F_4	Trouble on zone 4		
F_5	Trouble on zone 5	PH_2	Secondary C. S. Number Communications Fault
		F_A	Annunciator Fault

4.3.6 Trouble Condition Restoral

The control panel performs the following upon restoral of all trouble conditions.

- The trouble LED is shut OFF.
- The trouble relay deactivates.
- If the trouble was loss of AC power, the control panel will turn on the AC LED upon restoral.
- Clear the display of the trouble message(s).
- Communicate the restored trouble condition(s) to the central station.
- Output the system trouble restoral message to the printer.
- Terminate upload or download communications

4.3.7 OFF Normal Reporting

Removing the panel from Normal Mode and placing it into any other mode causes a transmission of an 'off normal' fault message. Returning the panel to Normal Mode causes a transmission of a 'return to normal' restoral message.

4.3.8 Zone Disable/Enable

The zone disable feature may be used to disable any zone in the system. Zones may be disabled if they are normal, in trouble or alarmed. *Zones may only be disabled during the normal mode of operation when the fire protection is active.*

If the panel is in alarm, the silence switch must be pressed first before zone disable will function.

To disable a zone, press the **MODE** key once, (the display will go blank) you then have 10 seconds to start entering the code **3472**. Next press the **[ENTER/STORE]** key.

☛ **3472** spells DISA on a Touch-Tone® phone

A flashing lower case **d** will appear on the far left of the display. Next, press the zone number to be disabled. The number will appear on the far right display character. Press **[ENTER/STORE]**. The zone is disabled. Note that the trouble relay is activated and the trouble LED blinks.

The zone disable message will remain on the display until the zone is re-enabled. To re-enable a zone, press the **MODE** key once, (the display will go blank) you then have 10 seconds to start entering the code **3622**. Next, press the **[ENTER/STORE]** key.

☛ **3622** spells ENAB on a Touch-Tone® phone

A flashing upper case **E** will appear on the left of the display. Next, press the zone number to be enabled. The number will appear on the far right display character. Press **[ENTER/STORE]**. The zone is re-enabled. Note that the trouble relay is restored to normal and the trouble LED is off.

4.3.9 Fire Drill

The **DRILL** (manual evacuate) feature turns on both Notification Appliance Circuits (if programmed as enabled) and turns off the silence LED. To perform a fire drill, press the **MODE** key followed by the code **3745** then enter. The display will read **dril**. The alarm relay is not activated. There is an option to transmit the fire drill report code to the Central Station.

☛ **3745** spells **dril** on a Touch-Tone® phone

During a fire drill, the **SILENCE** key will silence both Notification Appliance Circuits and the **RESET** key restores the panel to normal. *All zones remain active during a fire drill.*

4.4 Central Station Communications

The control panel transmits zone and system status reports to Central Stations via the public switched telephone network. Two supervised telephone line connections are made to interface the control panel to the telephone lines. Two 7-foot telephone cords are provided for this purpose.

The control panel supervises both telephone lines for proper voltage. A delay of two minutes will occur before a fault in either phone line connection is reported as a trouble. When a fault is detected, an audible trouble signal will sound, the yellow trouble LED will blink, the 4 character display will show either 'no 1' or 'no 2' (depending upon which telephone line has the fault. 'no 1' = Primary Line, 'no 2' = Secondary Line) and the trouble condition will be reported to a Central Station over the remaining good phone line.

The control panel comes with line seizure capability provided for both the primary and secondary telephone line interfaces. Any time that the control panel needs to make a call to a Central Station, line seizure will disconnect any local premises phones sharing the same telephone line.

All transmissions to Central Stations will be sent over the Primary Central Station phone line. In the event of noisy phone lines, transmissions will be sent over the backup Secondary phone line.

Two phone numbers must be programmed, the Primary Central Station phone number and the Secondary Central Station phone number. All system reports will be transmitted to the Primary Central Station phone number. Reports will automatically be sent to the Secondary Central Station phone number if attempts to transmit to the Primary Central Station phone number are unsuccessful. If 10 total attempts to communicate are unsuccessful, the Communicator Failure output will be turned on (TB4, terminal 6). Note that as an option, *all* reports may also be sent to the Secondary Central Station phone number.

The SA500C meets NFPA 72 National Fire Code reporting requirements for: (a) the type of signal (b) condition and (c) location of the reporting premises. The general priority reporting structure is:

1. Zone Alarms and Restores
2. Zone Troubles and Restores
3. System Troubles and Restores
4. 24-hour test

The control panel is capable of reporting detailed messages depending upon the format in use. Table 4-1 shows the reporting structure for all formats.

	Format # 0, 2, 4, 6, 8	Format # 3, 5, 7, 9	Format # 1, A, C	Format # B, D
Report	3+1/4+1/Standard 4+1 Express	3+1/4+1/Expanded	4+2/Standard 4+2 Express	4+2/Expanded
Alarm	SSS(S) A	SSS(S) A AAA(A) Z	SSSS AA2	SSSS AZ
Alarm Restore	SSS(S) RA	SSS(S) RA RARARA(RA) Z	SSSS RARA2	SSSS RAZ
Zone Trouble (Zone Open)	SSS(S) TZ	SSS(S) TZ TZTZTZ(TZ) Z	SSSS TZTZ2	SSSS TZZ
Zone Trouble Restore	SSS(S) RTZ	SSS(S) RTZ RTZRTZRTZ(RTZ)Z	SSSS RTZRTZ2	SSSS RTZZ
System Trouble	SSS(S) TS	SSS(S) TS TSTSTS(TS) Y	SSSS TSTS2	SSSS TSY
System Trouble Restore	SSS(S) RTS	SSS(S) RTS RTSRTSRTS(RTS) Y	SSSS RTSRTS2	SSSS RTSY
Zone Disable	SSS(S) DZ	SSS(S) DZ DZDZDZ(DZ)Z	SSSS DZDZ2	SSSS DZZ
Zone Disable Restore	SSS(S) RDZ	SSS(S) RDZ RDZRDZRDZ(RDZ)Z	SSSS RDZRDZ2	SSSS RDZZ
Low Battery	SSS(S) L	SSS(S) L	SSSS LL2	SSSSLL2
Low Battery Restore	SSS(S) RL	SSS(S) RL	SSSS RLRL2	SSSS RLRL2
AC Loss	SSS(S) P	SSS(S) P	SSSS PP2	SSSS PP2
AC Loss Restore	SSS(S) RP	SSS(S) RP	SSSS RPRP2	SSSS RPRP2
Fire Drill	SSS(S)Fd	SSS(S)Fd	SSSSFdFd2	SSSSFdFd2
Fire Drill Restore	SSS(S)RFd	SSS(S)RFd	SSSSRFdRFd2	SSSSRFdRFd2
Supervisory Condition	SSS(S) V	SSS(S) V VVV(V) Z	SSSS VV2	SSSS VZ
Supervisory Condition Restore	SSS(S) RV	SSS(S) RV RVRVRV(RV) Z	SSSS RVRV2	SSSS RVZ
Test Report	SSS(S) X	SSS(S) X	SSSS XX2	SSSS XX2
Up or Download	SSS(S) UD	SSS(S) UD	SSS UDUD2	SSS UDUD2

Table 4-1: Format Selection Addresses (16+42)

Refer to Table 4-2 for an explanation of each letter code in Table 4-1.
Refer to Table 4-3 for a list of compatible receivers.

Where:

SSS Or

SSSS	= Subscriber ID
A	= Alarm (1st digit)
A2	= Alarm (2nd digit)
Z	= Zone Number
RA	= Alarm Restore (1st digit)
RA2	= Alarm Restore (2nd digit)
TZ	= Zone Trouble (1st digit)
TZ2	= Zone Trouble (2nd digit)
RTZ	= Zone Trouble Restore (1st digit)
RTZ2	= Zone Trouble Restore (2nd digit)
TS	= System Trouble (1st digit)
TS2	= System Trouble (2nd digit)
RTS	= System Trouble Restore (1st digit)
RTS2	= System Trouble Restore (2nd digit)
DZ	= Zone Disable (1st digit)
DZ2	= Zone Disable (2nd digit)
RDZ	= Zone Disable Restore (1st digit)
RDZ2	= Zone Disable Restore (2nd digit)
L	= Low Battery (1st digit)
L2	= Low Battery (2nd digit)
RL	= Low Battery Restore (1st digit)
RL2	= Low Battery Restore (2nd digit)
P	= AC Loss (1st digit)
P2	= AC Loss (2nd digit)
RP	= AC Loss Restore (1st digit)
RP2	= AC Loss Restore (2nd digit)
FD	= Fire Drill (1st digit)
FD2	= Fire Drill (2nd digit)
RFD	= Fire Drill Restore (1st digit)
RFD2	= Fire Drill Restore (2nd digit)
V	= Supervisory Condition (1st digit)
V2	= Supervisory Condition (2nd digit)
RV	= Supervisory Condition Restore (1st digit)
RV2	= Supervisory Condition Restore (2nd digit)
X	= Test Report (1st digit)
X2	= Test Report (2nd digit)
Y	= A Trouble Corresponding to The Following: 7 = Ground Fault 8 = Low Battery 9 = No Battery A = Telco Primary Line Fault B = Telco Secondary Line Fault C = Main Bell Fault, Annunciator Fault D = Communication Fault to Primary Number E = Communication Fault to Secondary Number F = System Off Normal Fault/System Fault (Slave Operation, See Section 6.0)
UD	= Upload/download 1st digit
UD2	= Upload/download 2nd digit

Note: For Expanded Reporting, the control panel automatically adds the digit corresponding to the zone number, and the second digit corresponding to any system trouble condition. Only the first digit is programmable.

Table 4-2: Format Selection Address Explanation

4.4.1 Transmittal Priorities

The integral communicator transmits highest priority events first. Events in terms of priority are listed below in descending order:

1: Alarms (Highest Priority Level)

- Pull Stations
- Waterflow
- Smoke Detector
- Other Alarm Types

2: Supervisory Zone

3: System Troubles

- Zone Disabled
- Fire Drill
- AC Fail (After Delay)
- Zonal faults
- Earth fault
- Low battery/No battery
- Telephone line fault
- Notification Appliance Circuits fault
- Communication Trouble
- Annunciator Trouble
- System off Normal

4: Restoral Reports

- Zone Alarm
- Supervisory
- Zone(s) Enabled
- Fire Drill
- AC
- Zone Fault
- Earth
- Battery
- Telephone Line
- Notification Appliance Circuits
- Communication
- Annunciator Trouble
- System off Normal

5: 24 Hour Test (Lowest Priority)

Red LEDs are provided on the control panel circuit board to identify which telephone line is activated. Also a green LED (labeled 'Kissoff') will turn on whenever the control panel has successfully transmitted reports to the Central Station. The 'Kissoff' LED may turn on several times during communications with a Central Station.

The chart below shows UL listed receivers compatible with the SA500C:

Format # (Addresses 16 & 42)		Ademco 685 (1)	Silent Knight 9000	ITI CS-4000 (3)	FBI CP220FB	Osborne Hoffman Models 1 & 2	Radionics 6000/6500 (5)	Sescoa 3000R (7)
0	4+1 Ademco Express	✓			✓			
1	4+2 Ademco Express	✓			✓	✓(8)		
2	3+1/Standard/1800/2300	✓	✓ (2)	✓	✓ (4)	✓	✓(5,6)	✓
3	3+1/Expanded/1800/2300	✓	✓ (2)	✓	✓ (4)	✓		✓
4	3+1/Standard/1900/1400	✓	✓ (2)		✓ (4)	✓		✓
5	3+1/Expanded/1900/1400	✓	✓ (2)		✓ (4)	✓		✓
6	4+1/Standard/1800/2300	✓	✓ (2)	✓	✓ (4)	✓	✓ (5)	✓
7	4+1/Expanded/1800/2300	✓	✓ (2)		✓ (4)	✓		✓
8	4+1/Standard/1900/1400	✓	✓ (2)		✓ (4)	✓		✓
9	4+1/Expanded/1900/1400	✓	✓ (2)		✓ (4)	✓		✓
A	4+2/Standard/1800/2300	✓	✓ (2)	✓	✓ (4)	✓	✓ (5)	✓
B	4+2/Expanded/1800/2300	✓	✓ (2)		✓ (4)	✓		✓
C	4+2/Standard/1900/1400	✓	✓ (2)		✓ (4)	✓		✓
D	4+2/Expanded/1900/1400	✓	✓ (2)		✓ (4)	✓		✓
E	Not Used							
F	Not Used							

- (1) With 685-8 Line Card with Rev 4.4d software.
- (2) With 9002 Line Card Rev 9035 software or 9032 Line Card with 9326A software.
- (3) Rev. 4.0 software.
- (4) FBI CP220FB Rec-11 Line Card with Rev 2.6 software and a memory card with Rev 3.8 software.
- (5) Model 6500 with Rev 600 software.
- (6) Model 6000 with Rev 204 software.
- (7) With Rev B control card at Rev 1.4 software and Rev C line card at Rev 1.5 software.
- (8) Model 2 only.

Table 4-3: Compatible UL Listed Receivers

5.0 Servicing

5.1 Walk Test Mode

The SA500C provides the capability to perform a one-man walk test of the system without triggering the communicator, the zone relays, or the alarm output relay. Walk Test allows for testing of the five zones (initiating circuits). The first initiating device activated on a zone will cause the Notification Appliance Circuits to turn on for four seconds. Subsequent device activations on the same zone will cause the Notification Appliance Circuits to turn on for one second. Any smoke detectors that are activated will be reset. Zonal faults (open circuits) will cause the appliance circuit to remain on steadily. Prior to entering Walk Test Mode, check to be certain that all system faults have been cleared. *Note: The trouble relay will be activated while the control panel is in this mode. Placing the control panel into walk test mode will only be possible if the system has no active alarms.*

Pressing the **MODE** key followed by the 4-digit code **9255 [ENTER/STORE]** will place the control panel into Walk Test Mode.

☛ **9255** spells 'WALK' on a Touch-Tone® phone.

Once in Walk Test Mode, the control panel will immediately:

- Blink the trouble LED.
- Activate the trouble relay.
- Turn on the Notification Appliance Circuits for four seconds for the first alarm on a zone. Subsequent alarms will sound for one second. Troubles cause the Notification Appliance Circuits to remain on.
- Disable the alarm relay.
- Display all alarm conditions as they occur.
- Display all zone troubles as they occur.
- Display ground faults as they occur.
- Transmit 'off normal' message to Central Station(s).
- Continue to communicate any events not acknowledged at a Central Station prior to entering Walk Test Mode.

During Walk Test Mode, zonal activity is displayed in real time as it occurs. At the end of Walk Testing the system, the display will show the last event that occurred. To view all events stored during Walk Test, use the Up Arrow, Down Arrow and 1st Event keys. The Down Arrow key moves the Walk Test list to show older - previous events. The Up Arrow key moves the Walk Test list to show newer - most recent events. Pressing the 1st Event key at any time will cause the display of the first event stored upon initial entry into Walk Test Mode. While in Walk Test Mode, the control panel will store up to 128 events in the Walk Test File for later recall and display.

A printer may be connected to the panel during Walk Test. All Walk Test events are printed in real time as they occur.

To return the control panel to normal mode, press the mode key, the numbers **6676** and the **[ENTER/STORE]** key. Any delay between key entries greater than 10 seconds causes the control panel to remain in Walk Test Mode.

The control panel will automatically revert back to Normal Mode if no system activity has occurred for 60 minutes. This would include pressing any keys or activity on any zone. Exiting Walk Test mode leaves the Walk Test file in memory such that it may be printed in Print Mode. Subsequent entries into Walk Test mode delete the Walk test file.

Note: *Remote site upload or download is not possible in Walk Test mode.*

5.2 History Mode

All Normal Mode events are stored in a History File list for future recall. Recall is possible via the 4-character display or via an optional printer. See the following page for a list and description of each event displayed.

The History File list is a first-in first-out (FIFO). In this manner, only the most recent events may be called up from memory. Old events will be overwritten i.e., pushed out of the FIFO.

The number of stored events is 32. The History File is kept in E² memory. Complete power loss will not erase the list.

Pressing the **MODE** key followed by **4478 [ENTER/STORE]** places the control panel into History Mode. *This will not occur if there are any active alarm conditions present.* The event displayed, is the most recent event.

☛ **4478** spells HIST on a Touch-Tone® phone.

Once in History Mode, the control panel will:

- Blink the trouble LED.
- Activate the trouble relay.
- Disable the Notification Appliance Circuit(s).
- Disable the alarm relay.
- Display all events as they occurred since the last time the History File list was cleared. The most recent event will be displayed first.
- Ignore all other keys other than those mentioned in this section.
- Transmit the 'off normal' message to the Central Station(s).
- Continue to communicate any events not previously acknowledged at the Central Station prior to entering History Mode.

The Down Arrow key moves the History File to show older-previous events. The Up Arrow key moves the History file to show newer-most recent events.

Shown below is the list of messages as they will appear on the display:

DISPLAY	EVENT		
A__1	Zone 1 Alarm	d__1	Zone 1 disabled
A__2	Zone 2 Alarm	d__2	Zone 2 disabled
A__3	Zone 3 Alarm	d__3	Zone 3 disabled
A__4	Zone 4 Alarm	d__4	Zone 4 disabled
A__5	Zone 5 Alarm	d__5	Zone 5 disabled
SUP1	Supervisory 1 Alarm	E__1	Enable Zone 1
SUP2	Supervisory 2 Alarm	E__2	Enable Zone 2
SUP3	Supervisory 3 Alarm	E__3	Enable Zone 3
SUP4	Supervisory 4 Alarm	E__4	Enable Zone 4
SUP5	Supervisory 5 Alarm	E__5	Enable Zone 5
AC	AC Loss	PH_1	Primary C. S. # Communication Fault
F__1	Zone 1 Fault	PH_2	Secondary C. S. # Communication Fault
F__2	Zone 2 Fault		
F__3	Zone 3 Fault	no_b	No Battery
F__4	Zone 4 Fault	Lo_b	Low Battery
F__5	Zone 5 Fault	SILE	Silence Switch pressed
bEL1	Bell 1 Fault (open or short)	no_1	Primary Phone Line Fault
bEL2	Bell 2 Fault (open or short)	no_2	Secondary Phone Line Fault
F__E	Earth Fault	rES_	Reset Switch pressed
F__A	Annunciator Fault		

To erase the list from E² memory, press the **SILENCE** key twice before exiting the History Mode. A lack of keyboard activity for a period of 10 minutes will cause the control panel to return to normal mode. If a printer is connected to the panel, the history file will be printed upon successful entry into History Mode and a list of the most recent 32 events, time and date stamped, will print out.

Note: Remote site upload or download is not possible while the panel is in History mode.

5.3 Troubleshoot Mode

In this mode, system voltages may be displayed on the 4-character display. An internal voltmeter measures the voltage present at: (1) the zone inputs, (2) the AC power input (3) the battery terminal leads, (4) NAC #1, (5) NAC #2 and (6) Resettable 24 volt power. A lack of keyboard activity for a period of 20 minutes will cause the control panel to return to normal mode.

To get into the Troubleshoot Mode, press **MODE 8768** and **[ENTER/STORE]**.

☎ **8768** spells TROU on a Touch-Tone® phone.

Once in this mode, the control panel will:

- Blink the trouble LED.
- Activate the trouble relay.
- Disable the Notification Appliance Circuits.
- Disable the alarm relay.
- Transmit the 'off normal' message to the Central Station(s).
- Continue to communicate any events not yet acknowledged at the Central Station prior to entering Troubleshoot Mode.

Pressing **A [ENTER/STORE]** displays the AC input voltage. Pressing **B [ENTER STORE]** will display the Battery Voltage. Pressing **1** through **5** followed by **[ENTER/STORE]** displays the zone voltage of the selected zone. Pressing **b1** followed by **[ENTER/STORE]** displays the voltage on NAC #1. Pressing **b2** followed by **[ENTER/STORE]** displays the voltage on NAC #2. Pressing the **RESET** key followed by **[ENTER/STORE]** displays the resettable 24volt power. The **UP Arrow key**, **Down Arrow key** and **1st EVENT** keys do not function in this mode.

Zones

Below is listed the nominal threshold voltages for each zone:

Zone #	Normal w/E.O.L.	Shorted	Open CKT.
1	23.5V	0.00V	25.4V
2	23.5V	0.00V	25.4V
3	23.5V	0.00V	25.4V
4	23.5V	0.00V	25.4V
5	23.5V	0.00V	25.4V

Readings will vary proportionately depending upon system load and AC line voltage.

AC Line

Listed below is the AC line voltage range. The AC ON indicator will turn off when the AC line voltage drops below the Low Line threshold, and the trouble LED will turn on.

AC Line Voltage:	Low Line	Normal	High Line
SA500C	102VAC	115VAC	132VAC

Battery

Below is shown the critical battery threshold conditions:

	Normal	Low Battery	No Battery
Battery Voltage:	27.6V	20.4V	< 17.4V

Note: Make measurements after allowing 48 hours to charge depleted batteries. If batteries do not show normal readings, replace them.

Telephone Lines

Pressing **C** for touchtone dialing or **D** for rotary dialing, followed by **[ENTER/STORE]** causes seizure of the Primary phone line which in turn lights the red LED signifying Primary phone line active. After a delay of three seconds, the control panel goes off hook to acquire a dial tone.

The control panel keypad may be used as a telephone touchpad for number dialing. Once the first digit is pressed, the display will move the **C** or **D** character one position to the left, while placing the digit to be dialed on the farthest right display position. Continue to press the phone numbers to be dialed. Successive depressions of the **[ENTER/STORE]** key hangs up and picks up the phone (places the phone on or off the hook).

The secondary phone line may be tested by pressing the **E** key for touchtone dialing or the **F** key for rotary dialing and then following the same procedure used for the primary phone line.

A handset may be temporarily connected across transformer T1 as indicated in Figure 5-1. The handset, when connected across T1, may be used only as an amplifier/speaker and telephone with the control panel used for number dialing.

NAC 1 & 2

NAC voltage readings are nominally -2.32 volts when an EOL resistor of correct value is in place. A reading of 0.00 volts appears for shorts, -4.50 volts for opens. Intermediate readings are also available.

Note: Remote site upload or download is not possible while the panel is in Troubleshoot or Lamp Test mode.

Resettable Power

Resettable 24 volt power must read 24 volts + or - 10%.

5.4 Lamp Test

To perform a Lamp Test, press **MODE** then **5267** followed by **[ENTER/STORE]**. This will test all system LEDs. The LEDs will stay on for five seconds, then the control panel will return to normal mode.

☛ **5267** spells LAMP on a Touch-Tone® phone.

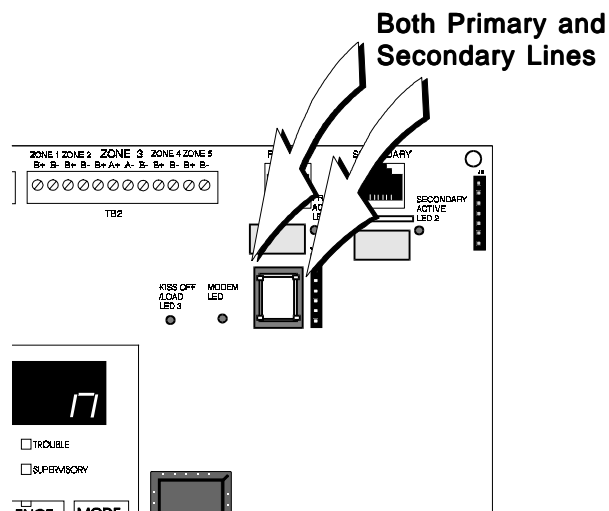

Figure 5-1: Handset/Speaker Connection

5.5

Print Mode

See Section Two, Figure 2-14 for proper PRT-24 Interface module connection to main circuit board before proceeding.

A printer may be temporarily or permanently connected to the panel. Programmable option address 78 must be programmed to a '2' if only a printer is connected or '3' if both a printer and annunciator are present to enable printer supervision. Once enabled, normal system status as well as panel operations will be printed. If the printer connection is removed, the trouble LED will blink, the piezo sounder will pulse and the 4-character LED display will be blank.

Selecting Printer Mode by pressing the **MODE** key followed by **7746** then **[ENTER/STORE]** will cause the display to read **Prn** and the following to be printed:

- 1 Entire program Entries
- 2 History File
- 3 Walktest File
- 4 Troubleshoot Mode Voltages
- 5 Current System Status

All activity is time and date stamped.

☛ **7746** spells PRIN on a Touch-Tone® phone.

Upon entering the print mode, the panel will transmit the 'System Off Normal' message to the Central Station. The panel will return to normal mode automatically after printing is completed. This typically will take three minutes.

Note: *Remote site upload or download is not possible while the panel is in Print Mode.*

6.0 Slave Communicator Configuration

The SA500C may be used as a slave communicator to a host or Master fire alarm control panel (FACP).

All wiring between the Master and the slave communicator is supervised. End of line resistors, 4.7K, should be connected.

In slave configuration, the five zones become five channels that may be triggered by the relay outputs of any host FACP. Zone 1/Channel 1 is used for general alarm, Zone 2/Channel 2 is used for general trouble, Zone 4/ Channel 4 is used for supervisory, and Zones 3 & 5/Channels 3 & 5 may be programmed to match the FACP relay function.

The factory settings for Zone 2/Channel 2 alarm and restoral are altered as follows: If 0, 2, 3, 4, 5, 6, 7, 8, 9, B or D is entered for address 16 or 42, the report code for Zone 2 Alarm Code (address 128, 252) = F, Zone 2 Restoral Code (address 156, 280) = E. If '1, A or C' are entered for address 16 or 42, the report code for Zone 2 Alarm Code (addresses 129-130, 253-254) = FF, Zone 2 restoral code (addresses 185-186, 309-310) = EF.

The factory settings for Zone 4/Channel 4 alarm and restoral are altered as follows: If 0, 2, 3, 4, 5, 6, 7, 8, B, or D is entered for address 16 or 42, report code for Zone 4/Channel 4 alarm code address (130, 254) = 8. Zone 4/Channel 4 restoral code (158, 282) = E. If 1, A or C are entered for addresses 16 or 42, the report code for Zone 4 alarm code addresses (133-134, 257-258) = 84, Zone 4 restoral code addresses (189-190, 313-314) = E4.

Location 56 must be programmed to a '1' to enable the control panel as a slave communicator.

Note: *Remote site upload or download is permitted in the Slave Communicator configuration, however alarm presignal and verification do not function in Slave mode.*

Be certain to connect the slave communicator's primary AC power to the same branch circuit as the host FACP.

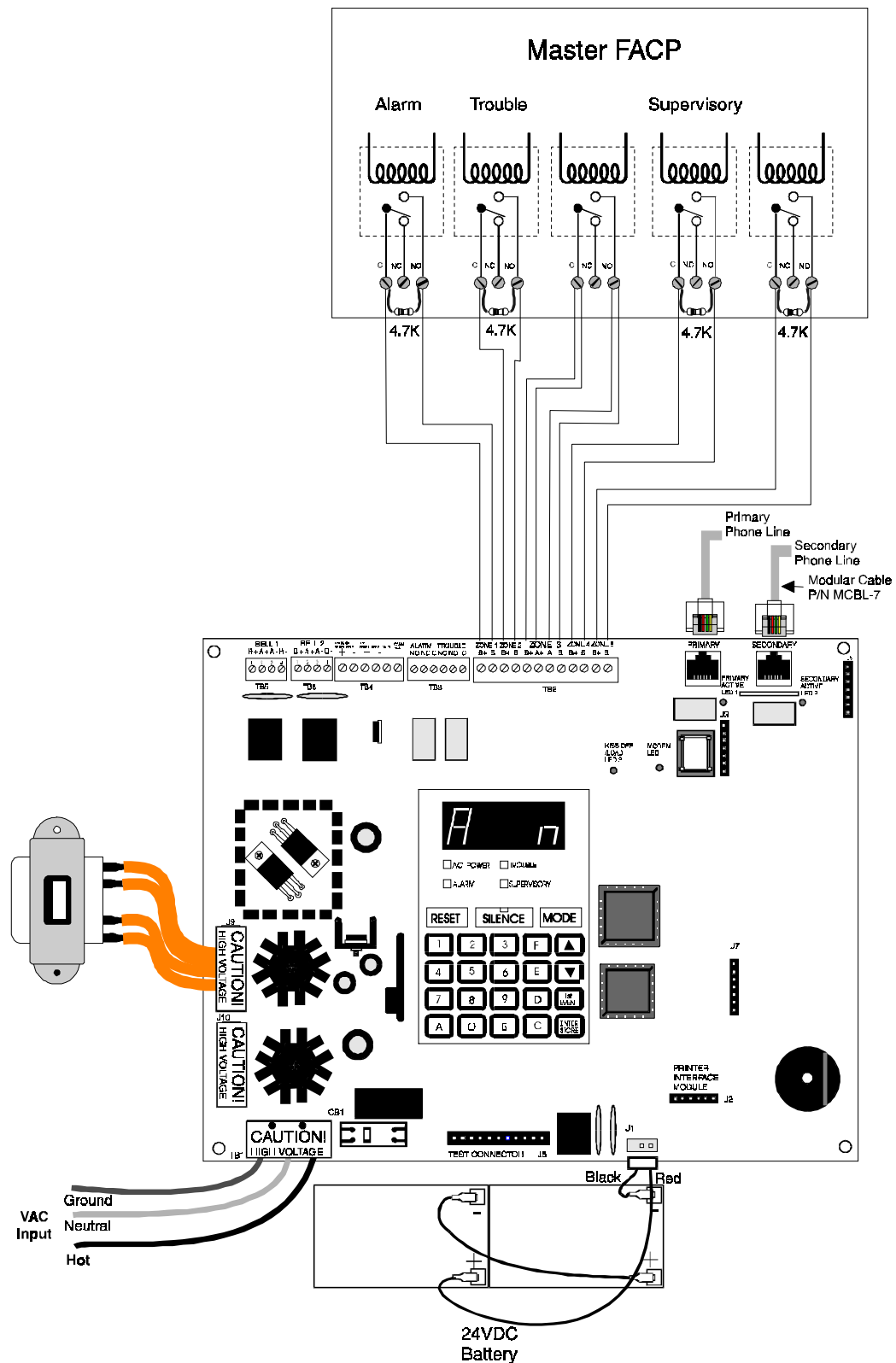

Relays in Master FACP activate various input circuits on the slave communicator. Messages (event codes) programmed for a particular input circuit (channel) will be transmitted to the central station upon relay activation.

Figure 6-1: Slave Communicator Connections

7.0 Remote Site Upload/Download

The control panel may be programmed or interrogated off site via the public switched telephone network. Any personal computer with DOS™ 4.01 or greater plus Windows™ 3.1 or greater, with a 1200 Baud Hayes™ compatible modem and Upload/Download software P/N PK-5024UD, may serve as a Service Terminal. This allows download of the entire program or upload of the entire program, history file, walktest data, current status, system voltages, time and date.

WARNING: After successful downloading, make certain to perform the following steps:

1. Print out all programmed data via print mode or manually view programmed entries and compare to intended program data.
2. Test all affected panel operations.
3. Immediately correct any problems found.

7.1 Downloading Program: General

The first time that the control panel is downloaded (whether initiated at the jobsite or remotely) a secret code is loaded in by a Service Terminal. Future upload or download requests cause verification of the secret code by the control panel before processing of data is allowed. If the secret code is not verified, the control panel will terminate the request.

While the control panel is communicating with the Service Terminal, the panel's green Modem LED and one of the red Line Seize LEDs will remain on steady. At the conclusion of a successful download, the green Kissoff LED will come on steady for five seconds, the green Modem LED will turn off and the red Line Seize LED will turn off.

In order to download the panel (whether initiated at the jobsite or remotely) the following must be true:

- ✓ The control panel must be in the Normal mode of operation. Downloading is not possible if the panel is in any other mode.
- ✓ There cannot be any active communications ongoing with a Central Station receiver.
- ✓ All active events must be successfully 'Kissed-off' by the Central Station(s). (The Communicator must be in a standby state with no new information waiting to be transmitted to a Central Station).

With program address location 56 = 1 or 2, anytime a download is initiated, the control panel will first contact the primary Central Station or both the primary and secondary Central Stations to report a 'request for up/download' message. Once the request is 'Kissed-off' by the Central Station(s), the control panel will then call the appropriate Service Terminal and begin the downloading process.

To prevent the 'request for up/download' message(s) from being reported to the Central Station(s), make certain to leave address 56 = 0 or disable all upload/download reports back to both Central Stations.

During the downloading process, the fire protection remains active. Should a system trouble or alarm condition occur, the control panel immediately terminates downloading and processes the trouble or alarm locally and transmits the information to the Central Station(s).

7.1.1 Security Features

Remote site upload and download with the control panel has been carefully designed to include key security features to insure proper functionality. The key features are listed and explained below.

Secret Code Verification

A secret code is stored in the control panel by a Service Terminal to prevent unauthorized access. The secret code is created at the Service Terminal by Master user and cannot be viewed or changed by anyone other than a Master user. Viewing of the secret code is prohibited at the control panel. Prior to allowing an upload or download of data, the control panel will verify the secret code transmitted by the Service Terminal.

Time-out at Control Panel

Upon answering an incoming call on either the primary or secondary Central Station phone line, the panel will listen for a modem connection signal. If this signal is not received within 30 seconds, the panel will disconnect the call.

Callback to Service Terminal

Any time that the panel is requested to allow an upload or download, it will confirm the source of the incoming call, hang-up and call the calling party (Service Terminal phone number) back.

Panel Identification Number

The panel identification number is typically used to identify the panel to the Service Terminal (when the panel calls the Service Terminal). If more than one call comes into the Service Terminal, the panel ID number is used to sort out the calling parties.

Another use of this code allows for identical secret codes to be placed into multiple panels at one jobsite using the panel ID number to distinguish between the individual panels.

Error Checking

As each block of data is received by the control panel, it is checked for accuracy. If an error is detected, the block is retransmitted until correct, up to a maximum of four times. If the Secret Code is not verified and four errors occur, the call is disconnected and the report that the upload/download was not successful is called to the Central Station(s).

Central Station Acknowledge

The 'Callback' option causes the control panel to report to one or both Central Stations that a request for up or downloading has been received prior to processing the call. If the Central Station(s) does not acknowledge receipt of this request, up or downloading is prohibited. If acknowledged by the Central Station(s), another message is transmitted informing the Central Station(s) that: (1) downloading was successful, (2) uploading was successful or (3) uploading/downloading was not successful.

Central Station Data Protection

Addresses '00' through '51' are assigned to the primary and secondary Central Station phone number, communication format, account code, and test time. Addresses '127' through '374' are reserved for the programmable event codes. This block of addresses holds the entire vital Central Station information. These blocks are protected from partial programming due to faulty phone connections, line noise and other errors. This prevents the panel from being confused due to a wrong phone number, account code, test time and most critical formatting errors.

7.2 Downloading Initiated at Control Panel

Before initiating the Download procedure, make certain that the control panel is: (1) in Normal mode, (2) Central Station communications are off or location 56 = 0, and (3) the communicator is in the standby state; red Line Seize LEDs are off, green Modem and Kissoff LEDs are off.

Place the control panel into Program mode and program one or both of the Service Terminal phone numbers. It is also advisable at this time to program the Panel Identification Number at addresses 84-87. This will allow the Service Terminal to easily identify incoming calls.

Exit the Program mode and return the panel to Normal mode. Press the **Mode** key followed by the 4-digit code **3696 [ENTER/STORE]**.

☛ **3696** spells DOWN on a Touch-Tone® phone.

The display to the far left will flash the letter 'S'. Press the digit '1' for Service Terminal phone #1 or '2' for Service Terminal #2, followed by **[ENTER/STORE]**. The control panel will now call the appropriate Service Terminal phone number and the downloading process will begin.

Once the called Service Terminal identifies the incoming call (control panel), the downloading process is allowed to continue. Downloading progresses until all programmed information has been successfully loaded into the control panel. (The programmed data may consist of addresses 00-374 plus the time and date.)

7.3 Downloading Initiated at a Service Terminal

Before initiating the Download procedure, make certain that the control panel is: (1) in Normal mode, (2) Central Station communications are off or location 56 = 0, and (3) the communicator is in the standby state; red Line Seize LEDs are off, green Modem and Kissoff LEDs are off.

Once an incoming call is accepted/answered by the control panel, the panel will:

1. Establish basic modem connection
2. Verify secret code and panel identification number
3. Verify callback vs. no callback request from the service terminal. If callback is requested, steps 4 through 9 occur. If no callback is requested, steps 8 and 9 will occur
4. Identify the Service Terminal location
5. Hang-up/Disconnect call
6. Call the Central Station(s) and transmit a message requesting upload/download (if programmed to do so). If this message is accepted, the control panel will proceed to the next step
7. Return call to Service Terminal
8. After security clearance, begin downloading
9. Upon completion of download, call Central Station(s) back and report either a successful download or failed upload/download message (if programmed to do so)

7.4 Uploading Initiated at a Service Terminal

Items that may be uploaded from the control panel to a Service Terminal are:

- All programmed data from addresses 00-374 plus the real time clock, time and date
- Entire Walk Test data file
- Troubleshoot Mode system voltages
- Entire 32 event History file
- Current system status

Uploading is possible at any time provided the following conditions are true:

- ✓ The control panel must be in the Normal mode of operation. Uploading is not possible if the panel is in any other mode.
- ✓ There cannot be any active communications ongoing with a Central Station receiver.
- ✓ All active events must be successfully 'Kissed-off' by the Central Station(s). (The Communicator must be in a standby state with no new information waiting to be transmitted to a Central Station).

Once an incoming call is accepted/answered by the control panel, the panel will:

1. Establish basic modem connection
2. Verify secret code and panel identification number
3. Verify callback vs. no callback request from the service terminal. If callback is requested, steps 4 through 9 occur. If no callback is requested, steps 8 and 9 will occur
4. Identify the Service Terminal location
5. Hang-up/Disconnect call
6. Call the Central Station(s) and transmit a request for upload/download message (if programmed to do so). If this message is accepted, the control panel will proceed to the next step
7. Return call to Service Terminal
8. After security clearance, begin uploading
9. Upon completion of upload, call Central Station(s) back and report either a successful upload or failed upload/download message (if programmed to do so)

During the uploading process, the fire protection remains active. Should a system trouble or alarm condition occur, the control panel immediately terminates uploading and processes the trouble or alarm locally and transmits the information to the Central Station(s).

Appendix A: Battery Calculations

Use the Total Standby and Alarm Load Currents calculated in Tables A-2A and A-2B for the following battery calculation.

Standby Load Current (Amps) []	X	Required Standby Time in Hours (24 or 60 Hours) []	=	_____
Alarm Load Current (Amps) []	X	Required Alarm Time in Hours (i.e. 5 min. = 0.084) []	=	_____
Add Standby and Alarm Load for Required Ampere Hour Battery			=	_____
Multiply by the Derating Factor of 1.2			=	_____
Total Ampere Hours (AH) Required			=	_____

Note:

- 1) 7 Ampere Hour battery can be located in the Backbox.
- 2) 12 Ampere Hour and 17 Ampere Hour batteries require the BB-17F Battery box.

The Main Power Supply

The SA500C provides regulated power for operating the fire alarm control panel, operating external devices, and operating the standby battery. The power for operating external devices is limited. Use Table A-2A (standby or non-alarm) and Table A-2B (alarm) to determine if external loading is within the capabilities of the power supply.

Concerning 4-wire smoke detectors: Be sure to power detectors from TB-4, Terminals 3 and 4.

Table A-2A: Regulated Load in Standby @24 VDC
External Devices connected to TB-4 only

Device Type	# of Devices	Current (Amps)	Total Current (Amps)
Main Circuit Board	1	X 0.1	= 0.1
ADM-24	(1 max.)	X 0.006	=
RZA-5F	(1 max.)	X 0	= 0
RM-5F	(1 max.)	X 0	= 0
CAC-5F	(1 max.)	X 0	= 0
2-wire Detector Heads	[]	X [] ¹	=
4-wire Detector Heads	[]	X [] ¹	=
Power Supervision ² Relays	[]	X 0.025	=
Current ³ Draw from TB-4 (non alarm)			=
Sum Column for Standby Load			= Amps

Note:

1. Refer to the Device Compatibility Document for 2-wire smoke detector standby current.
2. Must use compatible listed Power Supervision Relay.
3. The total standby current must include the sum of both the Resettable (TB4 Terminals 3 & 4) and Nonresettable (TB4 Terminals 5 & 6) power. Caution must be taken to ensure that current drawn from these outputs during alarm does not exceed maximum ratings specified (refer to Table A-2B).

Table A-2B: Regulated Load in Alarm @24 VDC

Device Type	# of Devices		Current (Amps)		Total Current (Amps)
Main Circuit Board	1	X	0.170	=	0.170 ⁵
ADM-24	(1 max.)	X	0.006	=	
RZA-5F	(1 max.)	X	0.046 ⁴	=	
RM-5F	(1 max.)	X	0.080 ⁴	=	
CAC-5F	(1 max.)	X	0	=	0
4-wire Smoke Detector ¹	[]	X	[]	=	
Power Supervision ³ Relay	[]	X	0.025	=	
Notification Appliances ¹	[]	X	_____	=	
Notification Appliances ¹	[]	X	_____	=	
Current Draw ¹ from TB4 (alarm current)				=	
Sum Column for Alarm Load ²				=	Amps

Notes:

- 1) Current limitations of terminals:
 - TB-4, Terminals 1 and 2 = 0.300 amp, regulated filtered, 24VDC +/- 5%, 120HZ ripple @ 10 mV_{RMS}. Non-Resettable Power.
 - TB-4, Terminals 3 and 4 = 0.300 amp, regulated filtered, 24VDC +/- 5%, 120HZ ripple @ 10 mV_{RMS}. Resettable Power.
 - TB-5, 2.5 amps.
 - TB-6, 2.5 amps.
- 2) Total current draw listed above cannot exceed:
 - 3.6 amps with standard transformer installed (only).
 - 5.6 amps with both the standard and optional transformers installed.
- 3) Must use compatible listed Power Supervision Relay.
- 4) The currents shown for the RZA-5F and RM-5F are for all five zones in alarm. For one zone in alarm, the RZA-5F current draw is 16 mA and the RM-5F current draw is 12 mA.
- 5) The current shown represents one zone on the Main Circuit Board in alarm. For all five zones in alarm, the current draw increases to 0.36 Amps.

Appendix B: Programming Reference Sheet

--- To enter Programming, press Mode: 7 7 6 4, Enter

₀₀ ₀₁ ₀₂ ₀₃ ₀₄ ₀₅ ₀₆ ₀₇ ₀₈ ₀₉ ₁₀ ₁₁ ₁₂ ₁₃ ₁₄ ₁₅

Addresses 00 to 15 store the Primary Central Station Phone Number. Enter 'F' to represent the end of the number.

₁₆ Primary Central Station Comm Format: Enter 0 - F.

₁₇ ₁₈ ₁₉ ₂₀ Primary Central Station Account Code: Valid keys are 0-F.

₂₁ ₂₂ ₂₃ ₂₄ Primary Central Station 24-Hour Test Time. Enter military time (i.e. 1400 for 2 pm).

₂₅ Primary Number Test Time Interval. Enter '0' for 24-hour; '1' - 12-hour; '2' - 8-hour; '3' for 6-hour.

₂₆ ₂₇ ₂₈ ₂₉ ₃₀ ₃₁ ₃₂ ₃₃ ₃₄ ₃₅ ₃₆ ₃₇ ₃₈ ₃₉ ₄₀ ₄₁

Addresses 26-41 store the Secondary Central Station Phone Number. Enter 'F' to represent the end of the number.

₄₂ Secondary Central Station Comm Format: Enter 0-F.

₄₃ ₄₄ ₄₅ ₄₆ Secondary Central Station Account Code: Valid keys are 0-F.

₄₇ ₄₈ ₄₉ ₅₀ Secondary Central Station 24-Hour Test Time. Enter military time (i.e. 1400 for 2 pm).

₅₁ Secondary Central Station Number Test Time Interval. Enter '0' for 24-hour; '1' - 12-hour; '2' - 8-hour; '3' for 6-hour.

₅₂ Alarm Verification. Enter '0' for no verification; '1' for verification of all 2-wire smoke zones

₅₃ ₅₄ ₅₅ Future Use.

₅₆ Slave Communicator/ Fire Panel Selection. Enter '0' for fire panel only; '1' for slave communicator only; '2' for fire panel/communicator operation.

₅₇ Zone 1 Function Select. Enter '0' for 2-wire smoke detectors; '1' for pull station; '2' for normally open contact devices; '3' for supervisory devices; '4' for supervisory devices (auto resettable).

₅₈ Zone 2 Function Select. Enter '0' for 2-wire smoke detectors; '1' for pull station; '2' for normally open contact devices; '3' for supervisory devices; '4' for supervisory devices (auto resettable).

₅₉ Zone 3 Function Select. Enter '0' for 2-wire smoke detectors; '1' for pull station; '2' for normally open contact devices; '3' for supervisory devices; '4' for supervisory devices (auto resettable); '5' for water-flow (silenceable); '6' for waterflow (non-silenceable).

₆₀ Zone 4 Function Select. Enter '0' for 2-wire smoke detectors; '1' for pull station; '2' for normally open contact devices; '3' for supervisory devices; '4' for supervisory devices (auto resettable).

₆₁ Zone 5 Function Select. Enter '0' for 2-wire smoke detectors; '1' for pull station; '2' for normally open contact devices; '3' for supervisory devices; '4' for supervisory devices (auto resettable).

₆₂ ₆₃ Waterflow Retard Timer. Enter 0-89 additional seconds.

























































































































































































































































₆₄ AC Loss Delay. Enter '0' for 6 hours; '1' for 7 hours; '2' for 8 hours; '3' for 9 hours; '4' for 10 hours; '5' for 11 hours; '6' for 12 hours; '7' for 15 hours; '8' for 16 hours; '9' for 17 hours; 'A' for 18 hours; 'B' for 19 hours; 'C' for 20 hours; 'D' for 21 hours; 'E' for 22 hours; or 'F' for 23 hours.

₆₅ Alarm Presignal. Enter '0' to disable; '1' to enable.

₆₆ ₆₇ ₆₈ Alarm Presignal Delay Time. Enter 0-179 additional seconds (default = 120 seconds).

- ₆₉ Notification Appliance Circuit #1 Selection: Enter '0' for enabled (silenceable); '1' for enable (non-silenceable); '2' to disable.
- ₇₀ Silence Inhibit NAC #1. Enter '0' for no silence inhibit; '1' to inhibit silencing of NAC #1 for one minute.
- ₇₁ Auto Silence NAC #1. Enter '0' for no auto silence; '1' for 5 minutes; '2' for 10 minutes; '3' for 15 minutes; '4' for 20 minutes; '5' for 25 minutes; '6' for 30 minutes.
- ₇₂ Coding NAC #1. Enter '0' for steady; '1' for March Time (120 ppm); '2' for California (10 seconds on, 5 seconds off); '3' for Temporal (0.5 on, 0.5 off, 0.5 on, 0.5 off, 0.5 on, 1.5 off).
- ₇₃ Notification Appliance Circuit #2 Selection: Enter '0' for enabled (silenceable); '1' for enable (non-silenceable); '2' to disable.
- ₇₄ Silence Inhibit NAC #2. Enter '0' for no silence inhibit; '1' to inhibit silencing of NAC #2 for one minute.
- ₇₅ Auto Silence NAC #2. Enter '0' for no auto silence; '1' for 5 minutes; '2' for 10 minutes; '3' for 15 minutes; '4' for 20 minutes; '5' for 25 minutes; '6' for 30 minutes.
- ₇₆ Coding NAC #2. Enter '0' for steady; '1' for March Time (120 ppm); '2' for California (10 seconds on, 5 seconds off); '3' for Temporal (0.5 on, 0.5 off, 0.5 on, 0.5 off, 0.5 on, 1.5 off).
- ₇₇ Trouble Reminder. Enter '0' to disable; '1' to enable.
- ₇₈ Annunciator/Printer Supervision. Enter '0' for annunciator/printer not present; '1' for annunciator present, '2' for printer present, or '3' for annunciator and printer present.
- ₇₉ Backup Reporting. Enter '0' to report to secondary phone # as backup only; '1' to report to secondary phone number for all reports/messages. Does not affect upload/download messages.
- ₈₀ Touchtone/Rotary Select. Enter '0' for touchtone dialing; '1' for rotary dialing.
- ₈₁ Make/Brake Ratio. Enter '0' for 67/33; '1' for 62/38.
- ₈₂ Future use.
- ₈₃ Future use.
- ₈₄ ₈₅ ₈₆ ₈₇ Panel Identification Number. Valid entries are 0-F.
- ₈₈ ₈₉ ₉₀ ₉₁ ₉₂ ₉₃ ₉₄ ₉₅ ₉₆ ₉₇ ₉₈ ₉₉ ₁₀₀ ₁₀₁ ₁₀₂ ₁₀₃
Service Terminal # 1 Phone Number. Addresses 88-103 store the phone number of Service Terminal #1. Enter 'F' to represent the end of the number.
- ₁₀₄ ₁₀₅ Ring Count on Primary Phone Line. Enter number of rings prior to panel answering call.
- ₁₀₆ FAX/Answer Machine, Primary Phone Line. Enter '0' for no sharing of phone line; '1' for sharing.
- ₁₀₇ ₁₀₈ ₁₀₉ ₁₁₀ ₁₁₁ ₁₁₂ ₁₁₃ ₁₁₄ ₁₁₅ ₁₁₆ ₁₁₇ ₁₁₈ ₁₁₉ ₁₂₀ ₁₂₁ ₁₂₂
Service Terminal # 2 Phone Number. Addresses 107-122 store the phone number of Service Terminal #2. Enter 'F' to represent the end of the number.
- ₁₂₃ ₁₂₄ Ring Count on Secondary Phone Line. Enter number of rings prior to panel answering call.
- ₁₂₅ FAX/Answer Machine, Secondary Phone Line. Enter '0' for no sharing of phone line; '1' for sharing.
- ₁₂₆ Upload/Download Backup Reporting. Enter '0' for Upload/Download reports to go to the Secondary C. S. Phone Number on backup only; '1' for Upload/Download reports to always go to the Secondary.

Programming Reference Sheet

												
127	128	129	130	131	132	133	134	135	136	137	138	139
												
140	141	142	143	144	145	146	147	148	149	150	151	152
												
153	154	155	156	157	158	159	160	161	162	163	164	165
												
166	167	168	169	170	171	172	173	174	175	176	177	178
												
179	180	181	182	183	184	185	186	187	188	189	190	191
												
192	193	194	195	196	197	198	199	200	201	202	203	204
												
205	206	207	208	209	210	211	212	213	214	215	216	217
												
218	219	220	221	222	223	224	225	226	227	228	229	230
												
231	232	233	234	235	236	237	238	239	240	241	242	243
												
244	245	246	247	248	249	250	251	252	253	254	255	256
												
257	258	259	260	261	262	263	264	265	266	267	268	269
												
270	271	272	273	274	275	276	277	278	279	280	281	282
												
283	284	285	286	287	288	289	290	291	292	293	294	295
												
296	297	298	299	300	301	302	303	304	305	306	307	308
												
309	310	311	312	313	314	315	316	317	318	319	320	321
												
322	323	324	325	326	327	328	329	330	331	332	333	334
												
335	336	337	338	339	340	341	342	343	344	345	346	347
												
348	349	350	351	352	353	354	355	356	357	358	359	360
												
361	362	363	364	365	366	367	368	369	370	371	372	373
												
374												

Programming Reference Sheet Factory Default Settings

--- To enter Programming, press Mode: 7 7 6 4, Enter

F₀₀ **F**₀₁ **F**₀₂ **F**₀₃ **F**₀₄ **F**₀₅ **F**₀₆ **F**₀₇ **F**₀₈ **F**₀₉ **F**₁₀ **F**₁₁ **F**₁₂ **F**₁₃ **F**₁₄ **F**₁₅

Addresses 00 to 15 store the Primary Central Station Phone Number. Enter 'F' to represent the end of the number.

A₁₆ Primary Central Station Comm Format: (4+2 Standard 1800/2300).

0₁₇ **0**₁₈ **0**₁₉ **0**₂₀ Primary Central Station Account Code.

2₂₁ **3**₂₂ **4**₂₃ **5**₂₄ Primary Central Station 24-Hour Test Time. 2345 = 11:45 PM.

0₂₅ Primary Central Station Number Test Time Interval. '0' for 24-hour.

F₂₆ **F**₂₇ **F**₂₈ **F**₂₉ **F**₃₀ **F**₃₁ **F**₃₂ **F**₃₃ **F**₃₄ **F**₃₅ **F**₃₆ **F**₃₇ **F**₃₈ **F**₃₉ **F**₄₀ **F**₄₁

Addresses 26-41 store the Secondary C. S. Phone Number. Enter 'F' to represent the end of the number.

A₄₂ Secondary Central Station Comm Format: (4+2 Standard 1800/2300).

0₄₃ **0**₄₄ **0**₄₅ **0**₄₆ Secondary Central Station Account Code.

0₄₇ **0**₄₈ **0**₄₉ **0**₅₀ Secondary Central Station 24-Hour Test Time. 0000 = 12:00 midnight.

0₅₁ Secondary Central Station Number Test Time Interval. '0' for 24-hour.

0₅₂ Alarm Verification. 0 = no alarm verification.

0₅₃ **0**₅₄ **0**₅₅ Future Use.

0₅₆ Slave Communicator/ Fire Panel Selection. 0 for panel only operation.

0₅₇ Zone 1 Function Select. '0' for 2-wire smoke detectors.

0₅₈ Zone 2 Function Select. '0' for 2-wire smoke detectors.

0₅₉ Zone 3 Function Select. '0' for 2-wire smoke detectors.

0₆₀ Zone 4 Function Select. '0' for 2-wire smoke detectors.

0₆₁ Zone 5 Function Select. '0' for 2-wire smoke detectors.

0₆₂ **0**₆₃ Waterflow Retard Timer. 00 for no delay.

0₆₄ AC Loss Delay. '0' for 6 hours.

0₆₅ Alarm Presignal. 0 for no alarm presignal.

1₆₆ **2**₆₇ **0**₆₈ Alarm Presignal Delay Time. 120 second alarm presignal delay.

0₆₉ Notification Appliance Circuit #1 Selection: '0' for enabled (silenceable).

0₇₀ Silence Inhibit NAC #1. '0' for no silence inhibit.

0₇₁ Auto Silence NAC #1. '0' for no auto silence.

- 0**₇₂ Coding NAC #1. '0' for steady, no coding.
- 0**₇₃ Notification Appliance Circuit #2 Selection: '0' for enabled (silenceable).
- 0**₇₄ Silence Inhibit NAC #2. '0' for no silence inhibit.
- 0**₇₅ Auto Silence NAC #2. '0' for no auto silence.
- 0**₇₆ Coding NAC #2. '0' for steady, no coding.
- 0**₇₇ Trouble Reminder. '0', no trouble reminder.
- 0**₇₈ Annunciator/Printer Supervision. '0' for annunciator/printer not present.
- 0**₇₉ Backup Reporting. '0' to report to secondary Central Station phone # as backup only.
- 0**₈₀ Touchtone/Rotary Select. '0' for touchtone dialing.
- 0**₈₁ Make/Brake Ratio. Enter '0' for 67/33.
- 0**₈₂ Future use. Leave default of '0'.
- 0**₈₃ Future use. Leave default of '0'.
- 0**₈₄ **0**₈₅ **0**₈₆ **0**₈₇ Panel Identification Number. Default is '0000'.
- F**₈₈ **F**₈₉ **F**₉₀ **F**₉₁ **F**₉₂ **F**₉₃ **F**₉₄ **F**₉₅ **F**₉₆ **F**₉₇ **F**₉₈ **F**₉₉ **F**₁₀₀ **F**₁₀₁ **F**₁₀₂ **F**₁₀₃
 Service Terminal # 1 Phone Number. Enter 'F' to represent the end of the number.
- 0**₁₀₄ **3**₁₀₅ Ring Count on Primary Phone Line. Default is '03' for do not answer until 3 rings are detected.
- 0**₁₀₆ FAX/Answer Machine, Primary Phone Line. Default is '0' for no sharing of phone line.
- F**₁₀₇ **F**₁₀₈ **F**₁₀₉ **F**₁₁₀ **F**₁₁₁ **F**₁₁₂ **F**₁₁₃ **F**₁₁₄ **F**₁₁₅ **F**₁₁₆ **F**₁₁₇ **F**₁₁₈ **F**₁₁₉ **F**₁₂₀ **F**₁₂₁ **F**₁₂₂
 Service Terminal # 2 Phone Number. Enter 'F' to represent the end of the number.
- 0**₁₂₃ **3**₁₂₄ Ring Count on Secondary Phone Line. Default is '03' for do not answer until 3 rings detected.
- 0**₁₂₅ FAX/Answer Machine, Secondary Phone Line. Default is '0' for no sharing of phone line.
- 0**₁₂₆ Upload/Download Backup Reporting. Default is '0' for Upload/Download reports to go to the Secondary Central Station Phone Number on backup only.

Programming Reference Sheet Factory Default

1 ₁₂₇	1 ₁₂₈	1 ₁₂₉	2 ₁₃₀	1 ₁₃₁	3 ₁₃₂	1 ₁₃₃	4 ₁₃₄	1 ₁₃₅	5 ₁₃₆	F ₁₃₇	1 ₁₃₈	F ₁₃₉
2 ₁₄₀	F ₁₄₁	3 ₁₄₂	F ₁₄₃	4 ₁₄₄	F ₁₄₅	5 ₁₄₆	9 ₁₄₇	7 ₁₄₈	F ₁₄₉	6 ₁₅₀	F ₁₅₁	1 ₁₅₂
F ₁₅₃	2 ₁₅₄	F ₁₅₅	3 ₁₅₆	F ₁₅₇	4 ₁₅₈	F ₁₅₉	5 ₁₆₀	F ₁₆₁	7 ₁₆₂	F ₁₆₃	8 ₁₆₄	F ₁₆₅
9 ₁₆₆	F ₁₆₇	A ₁₆₈	F ₁₆₉	B ₁₇₀	F ₁₇₁	C ₁₇₂	F ₁₇₃	C ₁₇₄	F ₁₇₅	D ₁₇₆	F ₁₇₇	E ₁₇₈
F ₁₇₉	C ₁₈₀	F ₁₈₁	F ₁₈₂	E ₁₈₃	1 ₁₈₄	E ₁₈₅	2 ₁₈₆	E ₁₈₇	3 ₁₈₈	E ₁₈₉	4 ₁₉₀	E ₁₉₁
5 ₁₉₂	E ₁₉₃	1 ₁₉₄	E ₁₉₅	2 ₁₉₆	E ₁₉₇	3 ₁₉₈	E ₁₉₉	4 ₂₀₀	E ₂₀₁	5 ₂₀₂	9 ₂₀₃	8 ₂₀₄
E ₂₀₅	6 ₂₀₆	E ₂₀₇	1 ₂₀₈	E ₂₀₉	2 ₂₁₀	E ₂₁₁	3 ₂₁₂	E ₂₁₃	4 ₂₁₄	E ₂₁₅	5 ₂₁₆	E ₂₁₇
7 ₂₁₈	E ₂₁₉	8 ₂₂₀	E ₂₂₁	9 ₂₂₂	E ₂₂₃	A ₂₂₄	E ₂₂₅	B ₂₂₆	E ₂₂₇	C ₂₂₈	E ₂₂₉	C ₂₃₀
E ₂₃₁	D ₂₃₂	E ₂₃₃	E ₂₃₄	E ₂₃₅	C ₂₃₆	E ₂₃₇	F ₂₃₈	9 ₂₃₉	9 ₂₄₀	9 ₂₄₁	1 ₂₄₂	7 ₂₄₃
1 ₂₄₄	7 ₂₄₅	2 ₂₄₆	7 ₂₄₇	3 ₂₄₈	7 ₂₄₉	4 ₂₅₀	1 ₂₅₁	1 ₂₅₂	1 ₂₅₃	2 ₂₅₄	1 ₂₅₅	3 ₂₅₆
1 ₂₅₇	4 ₂₅₈	1 ₂₅₉	5 ₂₆₀	F ₂₆₁	1 ₂₆₂	F ₂₆₃	2 ₂₆₄	F ₂₆₅	3 ₂₆₆	F ₂₆₇	4 ₂₆₈	F ₂₆₉
5 ₂₇₀	9 ₂₇₁	7 ₂₇₂	F ₂₇₃	6 ₂₇₄	F ₂₇₅	1 ₂₇₆	F ₂₇₇	2 ₂₇₈	F ₂₇₉	3 ₂₈₀	F ₂₈₁	4 ₂₈₂
F ₂₈₃	5 ₂₈₄	F ₂₈₅	7 ₂₈₆	F ₂₈₇	8 ₂₈₈	F ₂₈₉	9 ₂₉₀	F ₂₉₁	A ₂₉₂	F ₂₉₃	B ₂₉₄	F ₂₉₅
C ₂₉₆	F ₂₉₇	C ₂₉₈	F ₂₉₉	D ₃₀₀	F ₃₀₁	E ₃₀₂	F ₃₀₃	C ₃₀₄	F ₃₀₅	F ₃₀₆	E ₃₀₇	1 ₃₀₈
E ₃₀₉	2 ₃₁₀	E ₃₁₁	3 ₃₁₂	E ₃₁₃	4 ₃₁₄	E ₃₁₅	5 ₃₁₆	E ₃₁₇	1 ₃₁₈	E ₃₁₉	2 ₃₂₀	E ₃₂₁
3 ₃₂₂	E ₃₂₃	4 ₃₂₄	E ₃₂₅	5 ₃₂₆	9 ₃₂₇	8 ₃₂₈	E ₃₂₉	6 ₃₃₀	E ₃₃₁	1 ₃₃₂	E ₃₃₃	2 ₃₃₄
E ₃₃₅	3 ₃₃₆	E ₃₃₇	4 ₃₃₈	E ₃₃₉	5 ₃₄₀	E ₃₄₁	7 ₃₄₂	E ₃₄₃	8 ₃₄₄	E ₃₄₅	9 ₃₄₆	E ₃₄₇
A ₃₄₈	E ₃₄₉	B ₃₅₀	E ₃₅₁	C ₃₅₂	E ₃₅₃	C ₃₅₄	E ₃₅₅	D ₃₅₆	E ₃₅₇	E ₃₅₈	E ₃₅₉	C ₃₆₀
E ₃₆₁	F ₃₆₂	9 ₃₆₃	9 ₃₆₄	9 ₃₆₅	1 ₃₆₆	7 ₃₆₇	1 ₃₆₈	7 ₃₆₉	2 ₃₇₀	7 ₃₇₁	3 ₃₇₂	7 ₃₇₃
4 ₃₇₄												

Appendix C: Operation and Function Modes

OPERATION MODES

CODE	ACTIVITY	NOTES
6676 (NORM)	Returns to normal operation	Fire protection on.
7764 (PROG)	Enters Program Mode	4 levels of programming may be entered. Fire protection is off.
9255 (WALK)	Enters Walktest Mode	May select audible walktest function. Fire protection is off.
4478 (HIST)	View History File	Use display or printer to view History File. Fire protection is off.
8768 (TROU)	Activates internal system voltmeter for troubleshooting and diagnosing problems	Fire protection is off while voltmeter function is enabled.
7746 (PRIN)	Sends status, history file, walktest file, troubleshoot voltages and entire programming selections to printer	Fire protection is off. Requires PRT-24 option module
5267 (LAMP)	Turns on all LEDs on the main PCB and all system annunciators for 5 seconds	Fire protection is on.
3696 (DOWN)	Allows for downloading the entire program file to the panel	Must have service terminal ready. Fire protection remains on.

FUNCTION MODES

CODE	ACTIVITY	NOTES
3472 (DISA)	Allows disabling of any input zone	May only disable one zone at a time. Places system into trouble.
3622 (ENAB)	Allows enabling (return to normal) of any zone	May only enable one zone at a time.
3745 (DRIL)	Performs drill function by turning on all NAC outputs	Transmission of drill function to central station is defaulted to ON.
3337 (DEFP)	Reprograms all entries for programming back to the original factory settings	Entry of code must be performed two times in rapid succession as a safety feature. Use caution when using this feature

Notes

Notes

Limited Warranty

The manufacturer warrants its products to be free from defects in materials and workmanship for eighteen (18) months from the date of manufacture, under normal use and service. Products are date stamped at time of manufacture. The sole and exclusive obligation of the manufacturer is to repair or replace, at its option, free of charge for parts and labor, any part which is defective in materials or workmanship under normal use and service. For products not under manufacturing date-stamp control, the warranty is eighteen (18) months from date of original purchase by the manufacturer's distributor unless the installation instructions or catalog sets forth a shorter period, in which case the shorter period shall apply. This warranty is void if the product is altered, repaired or serviced by anyone other than the manufacturer or its authorized distributors or if there is a failure to maintain the products and systems in which they operate in a proper and workable manner. In case of defect, secure a Return Material Authorization form from our customer service department. Return product, transportation prepaid, to the manufacturer

This writing constitutes the only warranty made by the manufacturer with respect to its products. The manufacturer does not represent that its products will prevent any loss by fire or otherwise, or that its products will in all cases provide the protection for which they are installed or intended. Buyer acknowledges that the manufacturer is not an insurer and assumes no risk for loss or damages or the cost of any inconvenience, transportation, damage, misuse, abuse, accident or similar incident.

THE MANUFACTURER GIVES NO WARRANTY, EXPRESSED OR IMPLIED, OF MERCHANTABILITY, FITNESS FOR ANY PARTICULAR PURPOSE, OR OTHERWISE WHICH EXTEND BEYOND THE DESCRIPTION ON THE FACE HEREOF. UNDER NO CIRCUMSTANCES SHALL THE MANUFACTURER BE LIABLE FOR ANY LOSS OF OR DAMAGE TO PROPERTY, DIRECT, INCIDENTAL OR CONSEQUENTIAL, ARISING OUT OF THE USE OF, OR INABILITY TO USE THE MANUFACTURER'S PRODUCTS. FURTHERMORE, THE MANUFACTURER SHALL NOT BE LIABLE FOR ANY PERSONAL INJURY OR DEATH WHICH MAY ARISE IN THE COURSE OF, OR AS A RESULT OF, PERSONAL, COMMERCIAL OR INDUSTRIAL USE OF ITS PRODUCTS.

This warranty replaces all previous warranties and is the only warranty made by the manufacturer. No increase or alteration, written or verbal, of the obligation of this warranty is authorized.